

High-Resolution Analog I/O Board for Low Profile PCI

ADA16-8/2(LPCI)L



High-Resolution Analog Input Board
for Low Profile PCI

AD16-16(LPCI)L

High-Resolution Analog Output Board
for Low Profile PCI

DA16-4(LPCI)L

with Driver Library [API-PAC(W32)]

Features

- Rich set of basic functions
Compact system providing high-precision analog inputs/outputs. A series of three models selectable to meet the application.
< ADA16-8/2(LPCI)L > is a control single of analog input(16bits, 8ch), analog output(16bit, 2ch), analog I/O.
< AD16-16(LPCI)L > is a control signal(3 points) of analog input(16bits, 16ch), analog input.
< DA16-4(LPCI)L > is a control signal(3 points) of analog output(16bits, 4ch), analog output.
Digital inputs (four channels), digital outputs (four channels), and a counter (32-bit one channel) common to the three models.
- Substantial control functions
Capable of analog input/output in either time-based mode or external-signal synchronous mode.
- Filter function facilitating external signal connection
Digital filters provided for external control analog I/O signals, preventing chattering
- Buffer memory
The analog inputs and outputs each have their own buffer memory.
You can also perform analog input and output in the background, independent of software and the current status of the PC.
- Software-based calibration
Setting and calibrating the analog input and output can be performed completely by software.
No tricky jumper settings are required. You can also set your own calibration data in place of the default data set at the factory and use different calibration data depending on the operating conditions.
- Exchangeable low-profile and standard PCI slots
Support for both of low-profile and standard PCI slots (interchangeable with a bundled bracket).

This product is a PCI-compliant interface board that incorporates high-precision analog inputs, high-precision analog outputs, digital inputs, digital outputs, and a counter function.

The board can make your space-saving PC into a cost-effective analog input/output system.

Using the bundled API function library package [API-PAC(W32)], you can create Windows application software for this board in your favorite programming language supporting Win32 API functions, such as Visual Basic or Visual C/C++.

Cable & Connector

◆ **Cable & Connector (Option)**

Shield Cable with Two 50-Pin Mini-Ribbon Connector

: PCB50PS-0.5P (0.5m)

: PCB50PS-1.5P (1.5m)

Shield Cable with One 50-Pin Mini-Ribbon Connector

: PCA50PS-0.5P (0.5m)

: PCA50PS-1.5P (1.5m)

Accessories

◆ **Accessories (Option)**

Screw Terminal Unit(M3 terminal block, 50 points)

: EPD-50A *1

BNC Connector Screw Terminal Unit : ATP-8L *1

*1 PCB50PS-0.5P or PCB50PS-1.5P optional cable is required separately.

Product Configuration List

- Board (One of the following) ... 1
[ADA16-8/2(LPCI)L, AD16-16(LPCI)L or DA16-4(LPCI)L]
 - First step guide ... 1
 - CD-ROM *1 [API-PAC(W32)] ... 1
 - Bracket for PCI ... 1
- *1 The CD-ROM contains the driver software and User's Guide (this guide)

Specifications

ADA16-8/2(LPCI)L

Item	Specification
Analog input	
Isolated specification	Un-Isolated
Input type	Single-Ended Input
Number of input channels	8ch
Input range	Bipolar ±10V
Absolute max. input voltage	±20V
Input impedance	1MΩ or more
Resolution	16bit
Non-Linearity error *1*2	±5LSB
Conversion speed	10μsec/ch
Buffer memory	1k Word
Conversion start trigger	Software / external trigger
Conversion stop trigger	Number of sampling times / external trigger/software
External start signal	TTL level (Rising or falling edge can be selected by software) Digital filter (1μsec can be selected by software)
External stop signal	TTL level (Rising or falling edge can be selected by software) Digital filter (1μsec can be selected by software)
External clock signal	TTL level (Rising or falling edge can be selected by software)
Analog output	
Isolated specification	Un-Isolated
Number of output channels	2ch
Output range	Bipolar ±10V
Absolute max. input current	±3mA
Output impedance	1Ω or less
Resolution	16bit
Non-Linearity error *1	±5LSB
Conversion speed	10μsec
Buffer memory	1k Word
Conversion start trigger	Software / external trigger
Conversion stop trigger	Number of sampling times / external trigger/software
External start signal	TTL level (Rising or falling edge can be selected by software) Digital filter (1μsec can be selected by software)
External stop signal	TTL level (Rising or falling edge can be selected by software) Digital filter (1μsec can be selected by software)
External clock signal	TTL level (Rising or falling edge can be selected by software)
Digital I/O	
Number of input channels	4 TTL levels (positive logic)
Number of output channels	4 TTL levels (positive logic)
Counter	
Number of channels	1ch
Counting system	Up count
Max. count	FFFFFFFFh (Binary data,32bit)
Number of external inputs	2 TTL levels (Gate/Up)/ch Gate (High level), Up (Rising edge)
Number of external outputs	TTL Count match output (positive logic, pulse output)
Response frequency	10MHz (Max.)
Common section	
I/O address	64 ports
Interrupt level	Errors and various factors, One interrupt request line as INTA
Connector	10250-52A2JL[3M]
Power consumption	5VDC 380mA (Max.)
Operating condition	0 - 50°C, 10 - 90%RH (No condensation)
PCI bus specification	32bit, 33MHz, Universal key shapes supported *3
Dimension (mm)	121.69 (L) x 63.41 (H)
Weight	60g

- *1: The non-linearity error means an error of approximately 0.1% occurs over the maximum range at 0°C and 50°C ambient temperature.
- *2: At the time of the source use of a signal which built in the high-speed operational amplifier.
- *3: This board requires power supply at +5V from an expansion slot (it does not work on a machine with a +3.3V power supply alone).

AD16-16(LPCI)L

Item	Specification
Analog input	
Isolated specification	Un-Isolated
Input type	Single-Ended Input
Number of input channels	16ch
Input range	Bipolar ±10V
Absolute max. input voltage	±20V
Input impedance	1MΩ or more
Resolution	16bit
Non-Linearity error *1*2	±5LSB
Conversion speed	10μsec/ch
Buffer memory	1k Word
Conversion start trigger	Software / external trigger
Conversion stop trigger	Number of sampling times / external trigger/software
External start signal	TTL level (Rising or falling edge can be selected by software) Digital filter (1μsec can be selected by software)
External stop signal	TTL level (Rising or falling edge can be selected by software) Digital filter (1μsec can be selected by software)
External clock signal	TTL level (Rising or falling edge can be selected by software)
Digital I/O	
Number of input channels	4 TTL levels (positive logic)
Number of output channels	4 TTL levels (positive logic)
Counter	
Number of channels	1ch
Counting system	Up count
Max. count	FFFFFFFFh (Binary data,32bit)
Number of external inputs	2 TTL levels (Gate/Up)/ch Gate (High level), Up (Rising edge)
Number of external outputs	TTL Count match output (positive logic, pulse output)
Response frequency	10MHz (Max.)
Common section	
I/O address	64 ports
Interrupt level	Errors and various factors, One interrupt request line as INTA
Connector	10250-52A2JL[3M]
Power consumption	5VDC 260mA (Max.)
Operating condition	0 - 50°C, 10 - 90%RH (No condensation)
PCI bus specification	32bit, 33MHz, Universal key shapes supported *3
Dimension (mm)	121.69 (L) x 63.41 (H)
Weight	60g

- *1: The non-linearity error means an error of approximately 0.1% occurs over the maximum range at 0°C and 50°C ambient temperature.
- *2: At the time of the source use of a signal which built in the high-speed operational amplifier.
- *3: This board requires power supply at +5V from an expansion slot (it does not work on a machine with a +3.3V power supply alone).

■ AD16-16(LPCI)L

Item	Specification
Analog output	
Isolated specification	Un-Isolated
Number of output channels	4ch
Output range	Bipolar ±10V
Absolute max. output current	±3mA
Output impedance	1Ω or less
Resolution	16bit
Non-Linearity error *1	±5LSB
Conversion speed	10μsec
Buffer memory	1k Word
Conversion start trigger	Software / external trigger
Conversion stop trigger	Number of sampling times / external trigger/software
External start signal	TTL level (Rising or falling edge can be selected by software) Digital filter (1μsec can be selected by software)
External stop signal	TTL level (Rising or falling edge can be selected by software) Digital filter (1μsec can be selected by software)
External clock signal	TTL level (Rising or falling edge can be selected by software)
Digital I/O	
Number of input channels	4 TTL levels (positive logic)
Number of output channels	4 TTL levels (positive logic)
Counter	
Number of channels	1ch
Counting system	Up count
Max. count	FFFFFFFFh (Binary data, 32bit)
Number of external inputs	2 TTL levels (Gate/Up)/ch Gate (High level), Up (Rising edge)
Number of external outputs	TTL Count match output (positive logic, pulse output)
Response frequency	10MHz (Max.)
Common section	
I/O address	64 ports
Interruption level	Errors and various factors, One interrupt request line as INTA
Connector	10250-52A2JL[3M]
Power consumption	5VDC 440mA (Max.)
Operating condition	0 - 50°C, 10 - 90%RH (No condensation)
PCI bus specification	32bit, 33MHz, Universal key shapes supported *2
Dimension (mm)	121.69 (L) x 63.41 (H)
Weight	60g

*1: The non-linearity error means an error of approximately 0.1% occurs over the maximum range at 0°C and 50°C ambient temperature.

*2: This board requires power supply at +5V from an expansion slot (it does not work on a machine with a +3.3V power supply alone).

■ Board Dimensions

[ADA16-8/2(LPCI)L, AD16-16(LPCI)L, DA16-4(LPCI)L]

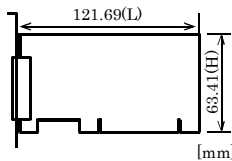

The standard outside dimension(L) is the distance from the end of the board to the outer surface of the slot cover.

Support Software

You should use CONTEC support software according to your purpose and development environment.

■ Driver Library API-PAC(W32) (Bundled)

API-PAC(W32) is the library software that provides the commands for CONTEC hardware products in the form of Windows standard Win32 API functions (DLL). It makes it easy to create high-speed application software taking advantage of the CONTEC hardware using various programming languages that support Win32 API functions, such as Visual Basic and Visual C/C++.

It can also be used by the installed diagnosis program to check hardware operations.

CONTEC provides download services (at <http://www.contec.com/apipac/>) to supply the updated drivers and differential files.

For details, read Help on the bundled CD-ROM or visit the CONTEC's Web site.

< Operating environment >

OS Windows XP, 2000, Me, 98, etc..
Adaptation language Visual C/C++, Visual Basic, Delphi, Builder, etc..

■ Linux version of analog I/O driver API-AIO(LNX) (Supplied: Stored on the API-PAC(W32) CD-ROM)

This driver is used to control CONTEC analog I/O boards (cards) from within Linux.

You can control CONTEC I/O boards easily using the shared library used by gcc and Kylix, the device driver (module) for each kernel version, and the board (card) configuration program (config).

CONTEC provides download services (at <http://www.contec.com/apipac/>) to supply the updated drivers and differential files.

For details, read Help on the bundled CD-ROM or visit the CONTEC's Web site.

< Operating environment >

OS RedHatLinux, TurboLinux, etc..
(For details on supported distributions, refer to Help available after installation.)

Adaptation language gcc, Kylix, etc..

Using the On-board Connectors

◆ Connecting a Device to a Connector

To connect an external device to this board, plug the cable from the device into the interface connector (CN1) shown below.

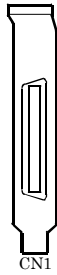
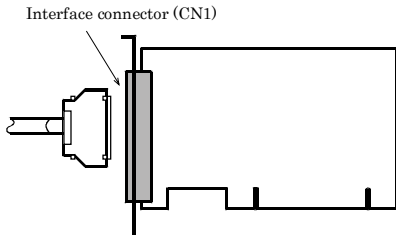

- Connector used
50-pin mini-ribbon connector
10250-52A2JL[mfd.by 3M]
- Applicable connector
10150-6000EL[mfd. by 3M]

Examples of Connecting Options

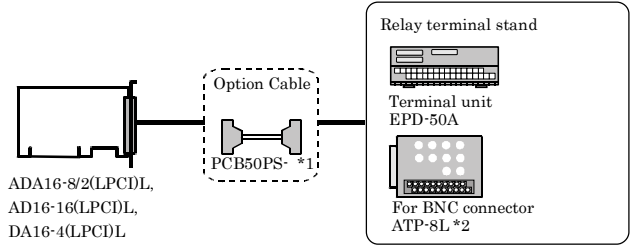

ADA16-8/2(LPCDL),
AD16-16(LPCDL),
DA16-4(LPCDL)

*1 : PCB50PS-0.5P(Recommended)

*2 : The ADA16-8/2(LPCDL) can use all of the analog inputs/outputs.
The AD16-16(LPCDL) can use up to eight analog inputs.
The DA16-4(LPCDL) can use up to two analog outputs.

◆ Connector Pin Assignment

■ Pin Assignments of ADA16-8/2(LPCI)L Interface Connector

Non Connect	N.C.	50	25	- AO 00	Analog Output 00
Analog Ground (for AO)	AGND	49	24	- AGND	Analog Ground (for AO)
Non Connect	N.C.	48	23	- AO 01	Analog Output 01
Analog Ground (for AO)	AGND	47	22	- AGND	Analog Ground (for AO)
Analog Input 04	AI 04	46	21	- AI 00	Analog Input 00
Non Connect	N.C.	45	20	- N.C.	Non Connect
Analog Input 05	AI 05	44	19	- AI 01	Analog Input 01
Non Connect	N.C.	43	18	- N.C.	Non Connect
Analog Ground (for AI)	AGND	42	17	- AGND	Analog Ground (for AI)
Analog Ground (for AI)	AGND	41	16	- AGND	Analog Ground (for AI)
Analog Input 06	AI 06	40	15	- AI 02	Analog Input 02
Non Connect	N.C.	39	14	- N.C.	Non Connect
Analog Input 07	AI 07	38	13	- AI 03	Analog Input 03
Non Connect	N.C.	37	12	- N.C.	Non Connect
AO External Start Trigger Input	AO START	36	11	- AI START	AI External Start Trigger Input
AO External Stop Trigger Input	AO STOP	35	10	- AI STOP	AI External Stop Trigger Input
AO External Sampling Clock Input	AO EXCLK	34	9	- AI EXCLK	AI External Sampling Clock Input
Digital Ground	DGND	33	8	- DGND	Digital Ground
Digital Output 00	DO 00	32	7	- DI 00	Digital Input 00
Digital Output 01	DO 01	31	6	- DI 01	Digital Input 01
Digital Output 02	DO 02	30	5	- DI 02	Digital Input 02
Digital Output 03	DO 03	29	4	- DI 03	Digital Input 03
Digital Ground	DGND	28	3	- DGND	Digital Ground
Counter UP Clock Input	CNT UPCLK	27	2	- CNT GATE	Counter Gate Control Input
Reserved	Reserved	26	1	- CNT OUT	Counter Output

Analog Input00 - Analog Input07	Analog input signal. The numbers correspond to channel numbers.
Analog Output00 - Analog Output01	Analog output signal. The numbers correspond to channel numbers.
Analog Ground	Common analog ground for analog I/O signals.
AI External Start Trigger Input	External trigger input for starting analog input sampling.
AI External Stop Trigger Input	External trigger input for stopping analog input sampling.
AI External Sampling Clock Input	External sampling clock input for analog input.
AO External Start Trigger Input	External trigger input for starting analog output sampling.
AO External Stop Trigger Input	External trigger input for stopping analog output sampling.
AO External Sampling Clock Input	External sampling clock input for analog output.
Digital Input00 - Digital Input03	Digital input signal.
Digital Output00 - Digital Output03	Digital output signal.
Counter Gate Control Input	Gate control input signal for counter.
Counter Up Clock Input	Count up clock input signal for counter.
Counter Output	Counter output signal.
Digital Ground	Common digital ground for digital I/O signals, external trigger inputs, external sampling clock inputs, and counter I/O signals.
Reserved	Reserved pin.
N.C.	No connection to this pin.

▼ CAUTION

- Do not connect any of the outputs and power outputs to the analog or digital ground. Neither connect outputs to each other. Doing either can result in a fault.
- If analog and digital ground are shorted together, noise on the digital signals may affect the analog signals. Accordingly, analog and digital ground should be separated.
- Leave "Reserved" pins unconnected. Connecting these pins may cause a fault in the board.

■ Pin Assignments of AD16-16(LPCI)L Interface Connector

Non Connect	N.C.	50	25	N.C.	Non Connect
Non Connect	N.C.	49	24	N.C.	Non Connect
Non Connect	N.C.	48	23	N.C.	Non Connect
Non Connect	N.C.	47	22	N.C.	Non Connect
Analog Input 04	AI 04	46	21	AI 00	Analog Input 00
Analog Input 12	AI 12	45	20	AI 08	Analog Input 08
Analog Input 05	AI 05	44	19	AI 01	Analog Input 01
Analog Input 13	AI 13	43	18	AI 09	Analog Input 09
Analog Ground (for AI)	AGND	42	17	AGND	Analog Ground (for AI)
Analog Ground (for AI)	AGND	41	16	AGND	Analog Ground (for AI)
Analog Input 06	AI 06	40	15	AI 02	Analog Input 02
Analog Input 14	AI 14	39	14	AI 10	Analog Input 10
Analog Input 07	AI 07	38	13	AI 03	Analog Input 03
Analog Input 15	AI 15	37	12	AI 11	Analog Input 11
Non Connect	N.C.	36	11	AI START	AI External Start Trigger Input
Non Connect	N.C.	35	10	AI STOP	AI External Stop Trigger Input
Non Connect	N.C.	34	9	AI EXCLK	AI External Sampling Clock Input
Digital Ground	DGND	33	8	DGND	Digital Ground
Digital Output 00	DO 00	32	7	DI 00	Digital Input 00
Digital Output 01	DO 01	31	6	DI 01	Digital Input 01
Digital Output 02	DO 02	30	5	DI 02	Digital Input 02
Digital Output 03	DO 03	29	4	DI 03	Digital Input 03
Digital Ground	DGND	28	3	DGND	Digital Ground
Counter UP Clock Input	CNT UPCLK	27	2	CNT GATE	Counter Gate Control Input
Reserved	Reserved	26	1	CNT OUT	Counter Output

Analog Input00 - Analog Input15	Analog input signal. The numbers correspond to channel numbers.
Analog Ground	Common analog ground for analog I/O signals.
AI External Start Trigger Input	External trigger input for starting analog input sampling.
AI External Stop Trigger Input	External trigger input for stopping analog input sampling.
AI External Sampling Clock Input	External sampling clock input for analog input.
Digital Input00 - Digital Input03	Digital input signal.
Digital Output00 - Digital Output03	Digital output signal.
Counter Gate Control Input	Gate control input signal for counter.
Counter Up Clock Input	Count-up clock input signal for counter.
Counter Output	Counter output signal.
Digital Ground	Common digital ground for digital I/O signals, external trigger inputs, external sampling clock inputs, and counter I/O signals.
Reserved	Reserved pin.
N.C.	No connection to this pin.

▼ CAUTION

- Do not connect any of the outputs and power outputs to the analog or digital ground. Neither connect outputs to each other. Doing either can result in a fault.
- If analog and digital ground are shorted together, noise on the digital signals may affect the analog signals. Accordingly, analog and digital ground should be separated.
- Leave "Reserved" pins unconnected. Connecting these pins may cause a fault in the board.

■ Pin Assignments of DA16-4(LPCI)L Interface Connector

Analog Output 02	AO 02	50	25	AO 00	Analog Output 00
Analog Ground (for AO)	AGND	49	24	AGND	Analog Ground (for AO)
Analog Output 03	AO 03	48	23	AO 01	Analog Output 01
Analog Ground (for AO)	AGND	47	22	AGND	Analog Ground (for AO)
Non Connect	N.C.	46	21	N.C.	Non Connect
Non Connect	N.C.	45	20	N.C.	Non Connect
Non Connect	N.C.	44	19	N.C.	Non Connect
Non Connect	N.C.	43	18	N.C.	Non Connect
Non Connect	N.C.	42	17	N.C.	Non Connect
Non Connect	N.C.	41	16	N.C.	Non Connect
Non Connect	N.C.	40	15	N.C.	Non Connect
Non Connect	N.C.	39	14	N.C.	Non Connect
Non Connect	N.C.	38	13	N.C.	Non Connect
Non Connect	N.C.	37	12	N.C.	Non Connect
AO External Start Trigger Input	AO START	36	11	N.C.	Non Connect
AO External Stop Trigger Input	AO STOP	35	10	N.C.	Non Connect
AO External Sampling Clock Input	AO EXCLK	34	9	N.C.	Non Connect
Digital Ground	DGND	33	8	DGND	Digital Ground
Digital Output 00	DO 00	32	7	DI 00	Digital Input 00
Digital Output 01	DO 01	31	6	DI 01	Digital Input 01
Digital Output 02	DO 02	30	5	DI 02	Digital Input 02
Digital Output 03	DO 03	29	4	DI 03	Digital Input 03
Digital Ground	DGND	28	3	DGND	Digital Ground
Counter UP Clock Input	CNT UPCLK	27	2	CNT GATE	Counter Gate Control Input
Reserved	Reserved	26	1	CNT OUT	Counter Output

Analog Output00 - Analog Output03	Analog output signal. The numbers correspond to channel numbers.
Analog Ground	Common analog ground for analog I/O signals.
AO External Start Trigger Input	External trigger input for starting analog output sampling.
AO External Stop Trigger Input	External trigger input for stopping analog output sampling.
AO External Sampling Clock Input	External sampling clock input for analog output.
Digital Input00 - Digital Input03	Digital input signal.
Digital Output00 - Digital Output03	Digital output signal.
Counter Gate Control Input	Gate control input signal for counter.
Counter Up Clock Input	Count-up clock input signal for counter.
Counter Output	Counter output signal.
Digital Ground	Common digital ground for digital I/O signals, external trigger inputs, external sampling clock inputs, and counter I/O signals.
Reserved	Reserved pin.
N.C.	No connection to this pin.

▼ CAUTION

- Do not connect any of the outputs and power outputs to the analog or digital ground. Neither connect outputs to each other. Doing either can result in a fault.
- If analog and digital ground are shorted together, noise on the digital signals may affect the analog signals. Accordingly, analog and digital ground should be separated.
- Leave "Reserved" pins unconnected. Connecting these pins may cause a fault in the board.

Analog Signal Connection

Analog signal input types are divided into single-ended input and differential input. This board uses single-ended input fixed. The following examples show how to connect analog input signals using a flat cable and a shielded cable.

◆ Single-ended Input

The following figure shows an example of flat cable connection. Connect separate signal and ground wires for each analog input channel on CN1.

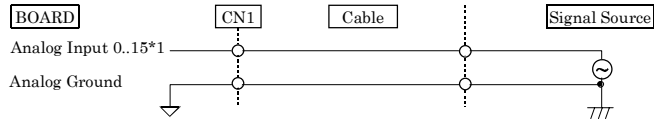

The following figure shows an example of shield cable connection. Use shielded cable if the distance between the signal source and board is long or if you want to provide better protection from noise. For each analog input channel on CN1, connect the core wire to the signal line and connect the shielding to ground.

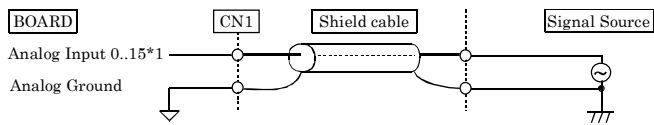

*1 The number of channels depends on each board.

The ADA16-8/2(LPCI)L has eight channels; the AD16-16(LPCI)L has 16 channels; the DA16-4(LPCI)L has no channel.

▼ CAUTION

- If the signal source contains over 1MHz signals, the signal may effect the cross-talk noise between channels.
- If the board and the signal source receive noise or the distance between the board and the signal source is too long, data may not be input properly.
- An input analog signal should not exceed the maximum input voltage (relate to the board analog ground). If it exceeds the maximum voltage, the board may be damaged.
- Connect all the unused analog input channels to analog ground.
- The signal connected to an input channel may fluctuate after switching of the multiplexer. If this occurs, shorten the cable between the signal source and the analog input board or insert a high-speed amplifier as a buffer between the two to reduce the fluctuation.

Analog Output Signal Connection

This section shows how to connect the analog output signal by using a flat cable or a shielded cable.

The following figure shows an example of flat cable connection.

Connect the signal source and ground to the CN1 analog output.

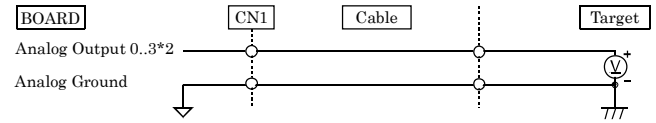

The following figure shows an example of shield cable connection.

Use shielded cable if the distance between the signal source and board is long or if you want to provide better protection from noise. For each analog input channel on CN1, connect the core wire to the signal line and connect the shielding to ground.

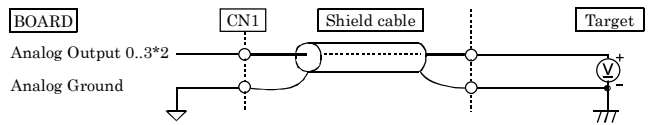

*2 The number of channels depends on each board.

The ADA16-8/2(LPCI)L has two channels; the AD16-16(LPCI)L has no channel; the DA16-4(LPCI)L has four channels.

▼ CAUTION

- If the board or the connected wire receives noise, or the distance between the board and the target is long, data may not be outputted properly.
- For analog output signal, the current capacity is +3mA (Max.). Check the specification of the connected device before connecting the board.
- Do not short the analog output signal to analog ground, digital ground, and/or power line. Doing so may damage the board.
- Do not connect an analog output signal to any other analog output, either on the board or on an external device, as this may cause a fault on the board.

Digital I/O signals, Counter signals and Control signals Connection

The following sections show examples of how to connect digital I/O signals, counter I/O signals, and other control I/O signals (external trigger input signals, sampling clock input signals, etc.).

All the digital I/O signals and control signals are TTL level signals.

Digital Input Connection

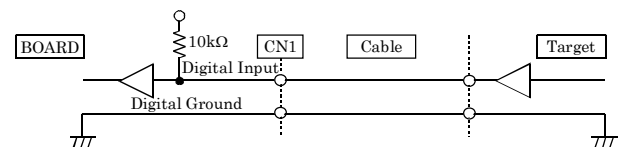

Digital Output Connection

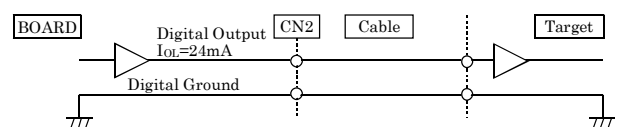

▼ CAUTION

- Do not short the output signals to analog ground, digital ground, and/or power line. Doing so may damage the board.

Block Diagram

■ ADA16-8/2(LPCI)L

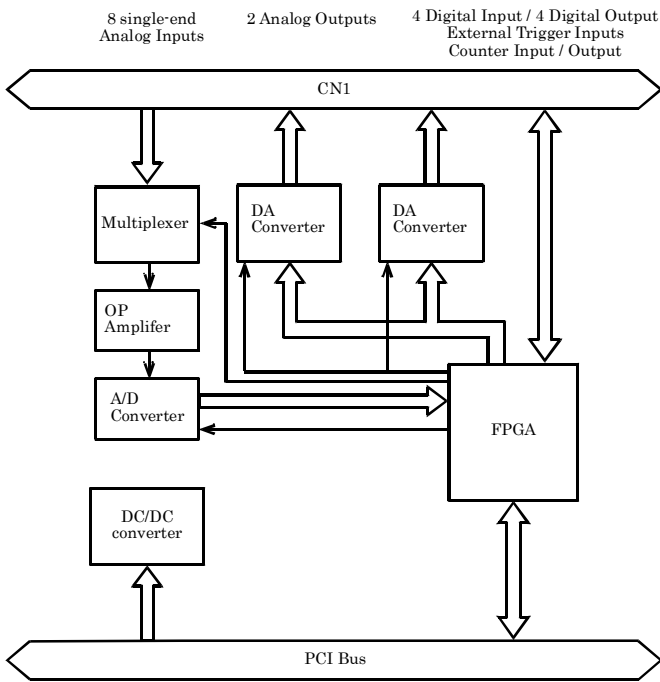

■ AD16-16(LPCI)L

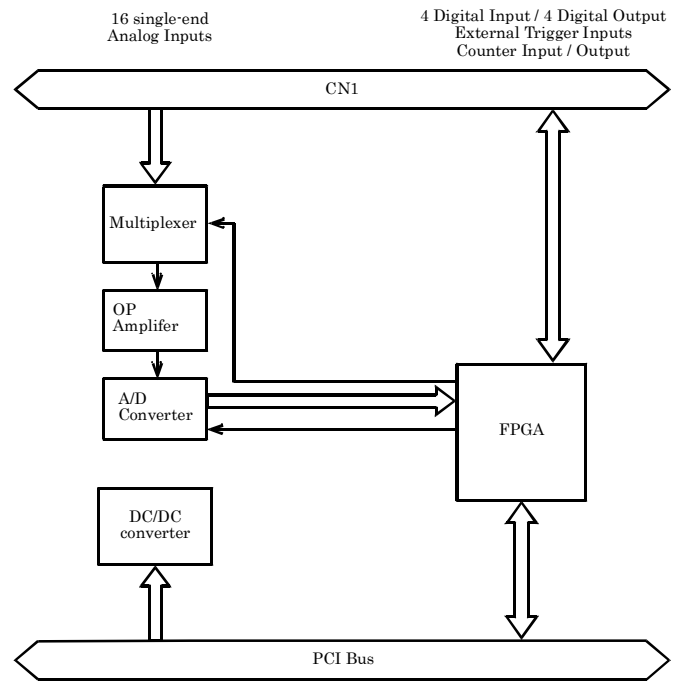

■ DA16-4(LPCI)L

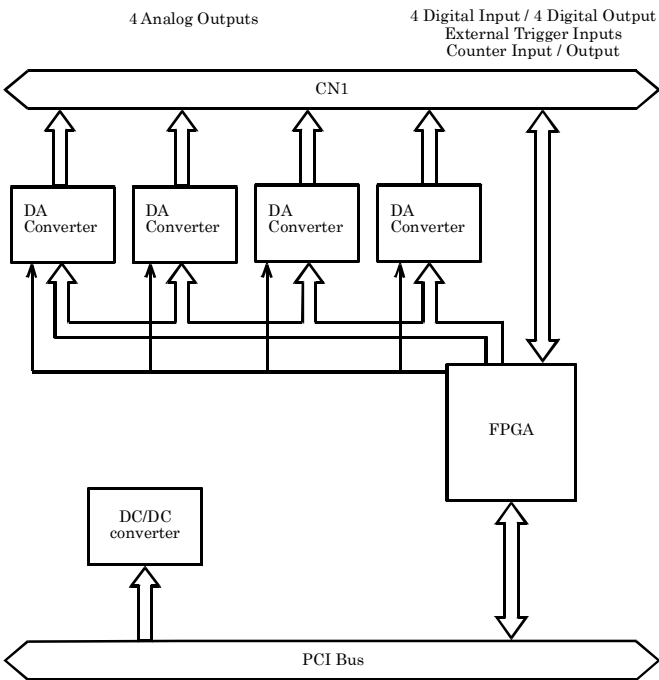

The specification, color, and design of a product may be changed without a preliminary announcement.