



MODEL:
SPCIE-C2060 Series

Full-Size PICMG 1.3 CPU Card Supports 32nm LGA1155 Intel® Xeon® E3 and Intel® Core™ i3 CPU, Intel® C206 Chipset, DDR3, VGA, DVI-D, Dual Intel® PCIe GbE, Two SATA 6Gb/s Ports, PCIe Mini, HD Audio and RoHS

User Manual

Revision

Date	Version	Changes
25 April, 2014	2.12	Modified LAN pinouts Updated Chapter 2: Packing List
9 July, 2013	2.11	Updated the optional LPT cable
8 April, 2013	2.10	Updated for R21 version
22 February, 2012	1.01	Updated the supported CPU type Updated Section 1.6: Data Flow Updated Appendix B: One Key Recovery
15 November, 2011	1.00	Initial release

Copyright

COPYRIGHT NOTICE

The information in this document is subject to change without prior notice in order to improve reliability, design and function and does not represent a commitment on the part of the manufacturer.

In no event will the manufacturer be liable for direct, indirect, special, incidental, or consequential damages arising out of the use or inability to use the product or documentation, even if advised of the possibility of such damages.

This document contains proprietary information protected by copyright. All rights are reserved. No part of this manual may be reproduced by any mechanical, electronic, or other means in any form without prior written permission of the manufacturer.

TRADEMARKS

All registered trademarks and product names mentioned herein are used for identification purposes only and may be trademarks and/or registered trademarks of their respective owners.

Table of Contents

1 INTRODUCTION.....	1
1.1 INTRODUCTION.....	2
1.2 MODEL VARIATIONS	3
1.3 FEATURES.....	3
1.4 CONNECTORS	4
1.5 DIMENSIONS.....	5
1.6 DATA FLOW	7
1.7 TECHNICAL SPECIFICATIONS	8
2 PACKING LIST.....	10
2.1 ANTI-STATIC PRECAUTIONS	11
2.2 UNPACKING PRECAUTIONS.....	11
2.3 PACKING LIST.....	12
2.4 OPTIONAL ITEMS	13
3 CONNECTORS	15
3.1 PERIPHERAL INTERFACE CONNECTORS.....	16
3.1.1 SPCIE-C2060 Series Layout.....	16
3.1.2 Peripheral Interface Connectors	16
3.1.3 External Interface Panel Connectors.....	17
3.2 INTERNAL PERIPHERAL CONNECTORS	18
3.2.1 12V Power Connector.....	18
3.2.2 Audio Kit Connector	18
3.2.3 Battery Connector.....	19
3.2.4 DDR3 DIMM Slots.....	20
3.2.5 Digital I/O Connector.....	21
3.2.6 DVI-D Connector (DVI Model Only)	22
3.2.7 Fan Connector (CPU).....	23
3.2.8 Front Panel Connector	24
3.2.9 PC Connector	25
3.2.10 Infrared Interface Connector.....	25

SPCIE-C2060 PICMG 1.3 CPU Card

3.2.11 Keyboard/Mouse Connector.....	26
3.2.12 Parallel Port Connector	27
3.2.13 PCIe Mini Card Slot	28
3.2.14 SATA 3Gb/s Drive Connector	30
3.2.15 SATA 6Gb/s Drive Connector	31
3.2.16 Serial Port Connectors, RS-232.....	31
3.2.17 Serial Port Connector, RS-422/485.....	32
3.2.18 SMBus Connector	33
3.2.19 SPI ROM Connector	34
3.2.20 TPM Connector.....	35
3.2.21 USB Connectors.....	36
3.3 EXTERNAL PERIPHERAL INTERFACE CONNECTOR PANEL	37
3.3.1 Ethernet Connectors	37
3.3.2 USB Connectors.....	38
3.3.3 VGA Connector.....	39
4 INSTALLATION	40
4.1 ANTI-STATIC PRECAUTIONS	41
4.2 INSTALLATION CONSIDERATIONS.....	41
4.2.1 Socket LGA1155 CPU Installation	43
4.2.2 Socket LGA1155 Cooling Kit Installation.....	46
4.2.3 DIMM Installation	47
4.3 JUMPER SETTINGS	48
4.3.1 AT/ATX Power Select Jumper.....	48
4.3.2 Clear CMOS Jumper.....	49
4.3.3 Wake-on LAN Jumper	50
4.4 CHASSIS INSTALLATION.....	51
4.4.1 Airflow.....	51
4.4.2 CPU Card Installation.....	51
4.5 INTERNAL PERIPHERAL DEVICE CONNECTIONS.....	51
4.5.1 Dual RS-232 Cable with Slot Bracket.....	51
4.5.2 DVI-D/USB Kit Installation (DVI Model Only).....	52
4.5.3 SATA Drive Connection	53
4.5.4 USB Cable (Dual Port) with Slot Bracket	55
4.5.5 PCIe Mini Card Installation	56

4.6 EXTERNAL PERIPHERAL INTERFACE CONNECTION	57
4.6.1 LAN Connection.....	57
4.6.2 USB Device Connection (Single Connector).....	58
4.6.3 VGA Monitor Connection	59
4.7 INTEL® AMT SETUP PROCEDURE.....	60
5 BIOS.....	62
5.1 INTRODUCTION.....	63
5.1.1 Starting Setup.....	63
5.1.2 Using Setup	63
5.1.3 Getting Help.....	64
5.1.4 Unable to Reboot after Configuration Changes	64
5.1.5 BIOS Menu Bar.....	64
5.2 MAIN.....	66
5.3 ADVANCED.....	67
5.3.1 ACPI Settings	68
5.3.2 RTC Wake Settings	69
5.3.3 Trusted Computing	71
5.3.4 CPU Configuration.....	71
5.3.5 SATA Configuration	73
5.3.6 Intel TXT(LT) Configuration.....	74
5.3.7 AMT Configuration	75
5.3.8 USB Configuration.....	76
5.3.9 F81866 Super IO Configuration	77
5.3.9.1 Serial Port n Configuration	77
5.3.9.2 IrDA Configuration.....	82
5.3.9.3 Parallel Port Configuration	83
5.3.10 F81866 H/W Monitor.....	84
5.3.10.1 Smart Fan Mode Configuration	85
5.3.11 Serial Port Console Redirection.....	86
5.3.12 iEi Feature	89
5.4 CHIPSET	90
5.4.1 System Agent (SA) Configuration	91
5.4.1.1 Graphics Configuration.....	91
5.4.1.2 NB PCIe Configuration.....	94

SPCIE-C2060 PICMG 1.3 CPU Card

5.4.1.3 Memory Configuration	95
5.4.2 <i>PCH-IO Configuration</i>	96
5.4.2.1 PCI Express Configuration	97
5.4.2.2 PCH Azalia Configuration	98
5.5 BOOT	99
5.6 SECURITY	101
5.7 SAVE & EXIT	102
6 SOFTWARE DRIVERS	104
6.1 AVAILABLE SOFTWARE DRIVERS	105
6.2 SOFTWARE INSTALLATION	105
6.3 CHIPSET DRIVER INSTALLATION	107
6.4 GRAPHICS DRIVER INSTALLATION	110
6.5 LAN DRIVER INSTALLATION	113
6.6 AUDIO DRIVER INSTALLATION	117
6.7 INTEL® RAPID STORAGE TECHNOLOGY DRIVER INSTALLATION	119
6.8 INTEL® AMT DRIVER AND APPLICATION	123
6.8.1 <i>Intel® Management Engine Components Installation</i>	123
6.8.2 <i>Intel® IT Director Application Installation</i>	127
A BIOS OPTIONS	134
B ONE KEY RECOVERY	137
B.1 ONE KEY RECOVERY INTRODUCTION	138
B.1.1 <i>System Requirement</i>	139
B.1.2 <i>Supported Operating System</i>	140
B.2 SETUP PROCEDURE FOR WINDOWS	141
B.2.1 <i>Hardware and BIOS Setup</i>	142
B.2.2 <i>Create Partitions</i>	142
B.2.3 <i>Install Operating System, Drivers and Applications</i>	146
B.2.4 <i>Build-up Recovery Partition</i>	147
B.2.5 <i>Create Factory Default Image</i>	149
B.3 AUTO RECOVERY SETUP PROCEDURE	154
B.4 SETUP PROCEDURE FOR LINUX	159
B.5 RECOVERY TOOL FUNCTIONS	162
B.5.1 <i>Factory Restore</i>	164

<i>B.5.2 Backup System</i>	165
<i>B.5.3 Restore Your Last Backup</i>	166
<i>B.5.4 Manual</i>	167
B.6 RESTORE SYSTEMS FROM A LINUX SERVER THROUGH LAN	168
<i>B.6.1 Configure DHCP Server Settings</i>	169
<i>B.6.2 Configure TFTP Settings</i>	170
<i>B.6.3 Configure One Key Recovery Server Settings</i>	171
<i>B.6.4 Start the DHCP, TFTP and HTTP</i>	172
<i>B.6.5 Create Shared Directory</i>	172
<i>B.6.6 Setup a Client System for Auto Recovery</i>	173
B.7 OTHER INFORMATION	176
<i>B.7.1 Using AHCI Mode or ALi M5283 / VIA VT6421A Controller</i>	176
<i>B.7.2 System Memory Requirement</i>	178
C TERMINOLOGY	179
D DIGITAL I/O INTERFACE	183
D.1 INTRODUCTION.....	184
D.2 DIO CONNECTOR PINOUTS	184
D.3 ASSEMBLY LANGUAGE SAMPLES.....	184
<i>D.3.1 Enable the DIO Input Function</i>	184
<i>D.3.2 Enable the DIO Output Function</i>	185
E WATCHDOG TIMER	186
F INTEL® MATRIX STORAGE MANAGER	189
F.1 INTRODUCTION.....	190
<i>F.1.1 Precautions</i>	190
F.2 FEATURES AND BENEFITS	191
F.3 ACCESSING THE INTEL® MATRIX STORAGE MANAGER.....	191
F.4 INSTALLING THE OPERATING SYSTEM TO THE RAID ARRAY	192
G HAZARDOUS MATERIALS DISCLOSURE	193
G.1 HAZARDOUS MATERIALS DISCLOSURE TABLE FOR IPB PRODUCTS CERTIFIED AS ROHS COMPLIANT UNDER 2002/95/EC WITHOUT MERCURY	194

List of Figures

Figure 1-1: SPCIE-C2060 Series.....	2
Figure 1-2: Connectors	4
Figure 1-3: SPCIE-C2060 Series Dimensions (mm)	5
Figure 1-4: External Interface Panel Dimensions (mm).....	6
Figure 1-5: Data Flow Diagram.....	7
Figure 3-1: Connectors and Jumpers.....	16
Figure 3-2: ATX Power Connector Pinout Location.....	18
Figure 3-3: Audio Connector Location	19
Figure 3-4: Battery Connector Location.....	20
Figure 3-5: DDR3 DIMM Slot Locations	21
Figure 3-6: Digital I/O Connector Location	21
Figure 3-7: DVI-D Connector Location	22
Figure 3-8: CPU Fan Connector Location	23
Figure 3-9: Front Panel Connector Location	24
Figure 3-10: I ² C Connector Location	25
Figure 3-11: Infrared Connector Location.....	26
Figure 3-12: Keyboard/Mouse Connector Location	27
Figure 3-13: Parallel Port Connector Location	28
Figure 3-14: PCIe Mini Card Slot Location.....	29
Figure 3-15: SATA 3Gb/s Drive Connector Location	30
Figure 3-16: SATA 6Gb/s Drive Connector Location	31
Figure 3-17: Serial Port Connector Location	32
Figure 3-18: RS-422/485 Connector Location.....	33
Figure 3-19: SMBus Connector Location	34
Figure 3-20: SPI Connector Location	35
Figure 3-21: TPM Connector Location.....	36
Figure 3-22: USB Connector Pinout Locations	37
Figure 3-23: External Peripheral Interface Connector	37
Figure 3-24: Ethernet Connector.....	38
Figure 3-25: VGA Connector	39

Figure 4-1: Disengage the CPU Socket Load Lever.....	43
Figure 4-2: Remove Protective Cover.....	44
Figure 4-3: Insert the Socket LGA1155 CPU.....	45
Figure 4-4: Close the Socket LGA1155	45
Figure 4-5: Cooling Kit Support Bracket.....	46
Figure 4-6: DIMM Installation.....	47
Figure 4-7: AT/ATX Power Mode Jumper Location.....	49
Figure 4-8: Clear BIOS Jumper Location	50
Figure 4-9: Wake-on LAN Connector Pinout Locations	50
Figure 4-10: Dual RS-232 Cable Installation	52
Figure 4-11: DVI-D/USB Kit Installation	53
Figure 4-12: SATA Drive Cable Connection.....	54
Figure 4-13: SATA Power Drive Connection.....	55
Figure 4-14: Dual USB Cable Connection	56
Figure 4-15: PCIe Mini Card Installation.....	57
Figure 4-16: LAN Connection	58
Figure 4-17: USB Device Connection	59
Figure 4-18: VGA Connector	60
Figure 6-1: Introduction Screen	106
Figure 6-2: Available Drivers	106
Figure 6-3: Chipset Driver Screen.....	107
Figure 6-4: Chipset Driver Welcome Screen.....	108
Figure 6-5: Chipset Driver License Agreement	108
Figure 6-6: Chipset Driver Read Me File	109
Figure 6-7: Chipset Driver Setup Operations	109
Figure 6-8: Chipset Driver Installation Finish Screen.....	110
Figure 6-9: Graphics Driver Welcome Screen	111
Figure 6-10: Graphics Driver License Agreement.....	111
Figure 6-11: Graphics Driver Read Me File	112
Figure 6-12: Graphics Driver Setup Operations	112
Figure 6-13: Graphics Driver Installation Finish Screen	113
Figure 6-14: Intel® Network Connection Menu.....	114
Figure 6-15: LAN Driver Welcome Screen	114
Figure 6-16: LAN Driver License Agreement.....	115
Figure 6-17: LAN Driver Setup Options.....	116

SPCIE-C2060 PICMG 1.3 CPU Card

Figure 6-18: LAN Driver Installation	116
Figure 6-19: LAN Driver Installation Complete.....	117
Figure 6-20: InstallShield Wizard Welcome Screen	118
Figure 6-21: Audio Driver Software Configuration.....	118
Figure 6-22: Restart the Computer	119
Figure 6-23: SATA RAID Driver Welcome Screen	120
Figure 6-24: SATA RAID Driver Warning.....	120
Figure 6-25: SATA RAID Driver License Agreement.....	121
Figure 6-26: SATA RAID Driver Read Me File	122
Figure 6-27: SATA RAID Driver Setup Operations	122
Figure 6-28: SATA RAID Driver Installation Finish Screen	123
Figure 6-29: Intel® ME Driver Welcome Screen	124
Figure 6-30: Intel® ME Driver License Agreement.....	125
Figure 6-31: Intel® ME Driver Read Me File	125
Figure 6-32: Intel® ME Driver Setup Operations	126
Figure 6-33: Intel® ME Driver Installation Finish Screen	127
Figure 6-34: IT Director Welcome Screen	128
Figure 6-35: IT Director License Agreement.....	129
Figure 6-36: IT Director Installation	129
Figure 6-37: IT Director Installation Complete.....	130
Figure 6-38: IT Director Configuration Tool Welcome Screen.....	131
Figure 6-39: IT Director – Creating Password	132
Figure 6-40: IT Director Configuration Complete	132
Figure B-1: IEI One Key Recovery Tool Menu	138
Figure B-2: Launching the Recovery Tool	143
Figure B-3: Recovery Tool Setup Menu	143
Figure B-4: Command Mode.....	144
Figure B-5: Partition Creation Commands.....	145
Figure B-6: Launching the Recovery Tool	147
Figure B-7: Manual Recovery Environment for Windows	147
Figure B-8: Building the Recovery Partition.....	148
Figure B-9: Press Any Key to Continue	148
Figure B-10: Press F3 to Boot into Recovery Mode.....	149
Figure B-11: Recovery Tool Menu	149
Figure B-12: About Symantec Ghost Window.....	150

Figure B-13: Symantec Ghost Path	150
Figure B-14: Select a Local Source Drive	151
Figure B-15: Select a Source Partition from Basic Drive	151
Figure B-16: File Name to Copy Image to	152
Figure B-17: Compress Image.....	152
Figure B-18: Image Creation Confirmation	153
Figure B-19: Image Creation Complete	153
Figure B-20: Image Creation Complete	153
Figure B-21: Press Any Key to Continue	154
Figure B-22: Auto Recovery Utility	155
Figure B-23: Disable Automatically Restart.....	155
Figure B-24: Launching the Recovery Tool	156
Figure B-25: Auto Recovery Environment for Windows	156
Figure B-26: Building the Auto Recovery Partition.....	157
Figure B-27: Factory Default Image Confirmation	157
Figure B-28: Image Creation Complete	158
Figure B-29: Press any key to continue	158
Figure B-30: Partitions for Linux.....	160
Figure B-31: System Configuration for Linux.....	161
Figure B-32: Access menu.lst in Linux (Text Mode).....	161
Figure B-33: Recovery Tool Menu	162
Figure B-34: Recovery Tool Main Menu	163
Figure B-35: Restore Factory Default.....	164
Figure B-36: Recovery Complete Window	164
Figure B-37: Backup System.....	165
Figure B-38: System Backup Complete Window	165
Figure B-39: Restore Backup	166
Figure B-40: Restore System Backup Complete Window	166
Figure B-41: Symantec Ghost Window	167
Figure B-42: Disable Automatically Restart.....	174

List of Tables

Table 1-1: SPCIE-C2060 Series Model Variations	3
Table 1-2: SPCIE-C2060 Series Specifications	9
Table 2-1: Packing List.....	13
Table 2-2: Optional Items	14
Table 3-1: Peripheral Interface Connectors	17
Table 3-2: Rear Panel Connectors	18
Table 3-3: ATX Power Connector Pinouts	18
Table 3-4: Audio Connector Pinouts	19
Table 3-5: Battery Connector (BT2) Pinouts	20
Table 3-6: Digital I/O Connector Pinouts.....	22
Table 3-7: DVI-D Connector Pinouts.....	23
Table 3-8: CPU Fan Connector Pinouts.....	23
Table 3-9: Front Panel Connector Pinouts.....	24
Table 3-10: I ² C Connector Pinouts.....	25
Table 3-11: Infrared Connector Pinouts	26
Table 3-12: Keyboard/Mouse Connector Pinouts	27
Table 3-13: Parallel Port Connector Pinouts	28
Table 3-14: PCIe Mini Card Slot Pinouts	30
Table 3-15: SATA 3Gb/s Drive Connector Pinouts.....	30
Table 3-16: SATA 6Gb/s Drive Connector Pinouts.....	31
Table 3-17: Serial Port Connector Pinouts	32
Table 3-18: RS-422/485 Connector Pinouts	33
Table 3-19: DB-9 RS-422/485 Pinouts.....	33
Table 3-20: SMBus Connector Pinouts	34
Table 3-21: SPI Connector Pinouts.....	35
Table 3-22: TPM Connector Pinouts.....	36
Table 3-23: USB Port Connector Pinouts.....	37
Table 3-24: LAN Pinouts	38
Table 3-25: Connector LEDs.....	38
Table 3-26: USB Port Pinouts.....	39

Table 3-27: VGA Connector Pinouts.....	39
Table 4-1: Jumpers	48
Table 4-2: AT/ATX Power Mode Jumper Settings	49
Table 4-3: Clear BIOS Jumper Settings.....	49
Table 4-4: Wake-on LAN Connector Pinouts	50
Table 5-1: BIOS Navigation Keys	64
Table 6-1: Digital I/O Connector Pinouts.....	184

BIOS Menus

BIOS Menu 1: Main	66
BIOS Menu 2: Advanced	68
BIOS Menu 3: ACPI Configuration	68
BIOS Menu 4: RTC Wake Settings	70
BIOS Menu 5: Trusted Computing	71
BIOS Menu 6: CPU Configuration	72
BIOS Menu 7: SATA Configuration	73
BIOS Menu 8: Intel TXT(LT) Configuration	74
BIOS Menu 9: AMT Configuration	75
BIOS Menu 10: USB Configuration	76
BIOS Menu 11: Super IO Configuration.....	77
BIOS Menu 12: Serial Port n Configuration Menu	77
BIOS Menu 13: IrDA Configuration Menu.....	82
BIOS Menu 14: Parallel Port Configuration Menu	83
BIOS Menu 15: F81866 H/W Monitor	85
BIOS Menu 16: Smart Fan Mode Configuration	86
BIOS Menu 17: Serial Port Console Redirection	87
BIOS Menu 18: iEi Feature	89
BIOS Menu 19: Chipset	90
BIOS Menu 20: System Agent (SA) Configuration	91
BIOS Menu 21: Graphics Configuration	92
BIOS Menu 22: LCD Control	93
BIOS Menu 23: NB PCIe Configuration	94
BIOS Menu 24: Memory Configuration.....	95
BIOS Menu 25: PCH-IO Configuration	96
BIOS Menu 26: PCI Express Configuration	97
BIOS Menu 27: PCH Azalia Configuration Menu	98
BIOS Menu 28: Boot	99
BIOS Menu 29: Security	101
BIOS Menu 30: Save & Exit.....	102

BIOS Menu 31: IEI Feature..... 159

Chapter

1

Introduction

1.1 Introduction

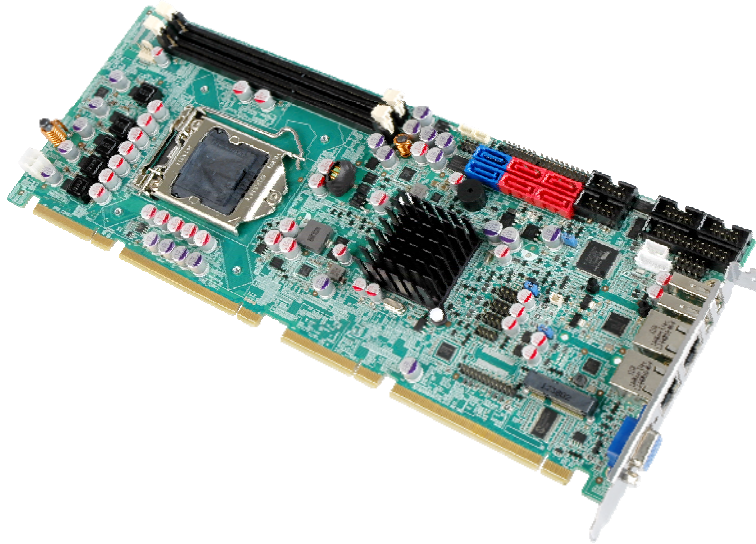

Figure 1-1: SPCIE-C2060 Series

The SPCIE-C2060 Series is a PICMG 1.3 CPU card. It accepts a Socket LGA1155 Intel® Xeon® E3 or Core™ i3 processor and supports two 240-pin 1066/1333 MHz dual-channel DDR3 DIMM modules up to 16.0 GB.

The SPCIE-C2060 Series supports two GbE interfaces through the Intel® 82579 Ethernet PHY (with Intel® AMT 7.0 support) and the Intel® 82574L Ethernet controller.

The integrated Intel® C206 chipset supports two SATA 6Gb/s and four SATA 3Gb/s drives. Two USB 2.0 on the rear panel, six USB 2.0 by pin header and one PCIe Mini interface provide flexible expansion options. High Definition Audio (HDA) support ensures HDA devices can be easily implemented on the SPCIE-C2060 Series.

SPCIE-C2060 PICMG 1.3 CPU Card

1.2 Model Variations

The model variations of the SPCIE-C2060 Series are listed below.

Model No.	CPU Supported	DVI-D by 26-pin header
SPCIE-C2060-DVI-R10	LGA1155 Intel® Xeon® E3 and Intel® Core™ i3	Yes
SPCIE-C2060-R10	LGA1155 Intel® Xeon® E3 and Intel® Core™ i3	No

Table 1-1: SPCIE-C2060 Series Model Variations

1.3 Features

Some of the SPCIE-C2060 Series motherboard features are listed below:

- PICMG 1.3 full-size graphics grade solution
- LGA1155 CPU socket
- Intel® C206 chipset
- Dual-channel DDR3 DIMMs support up to 16.0 GB
- Dual independent display by VGA and DVI-D (DVI model only)
- One PCIe Mini expansion slot
- Two Intel® PCIe Gigabit Ethernet connectors (LAN2 with Intel® AMT 7.0 support)
- Two SATA 6Gb/s connectors with RAID function
- Four SATA 3Gb/s connectors with RAID function
- TPM V1.2 hardware security function supported by the TPM module
- High Definition Audio
- RoHS compliant

1.4 Connectors

The connectors on the SPCIE-C2060 Series are shown in the figure below.

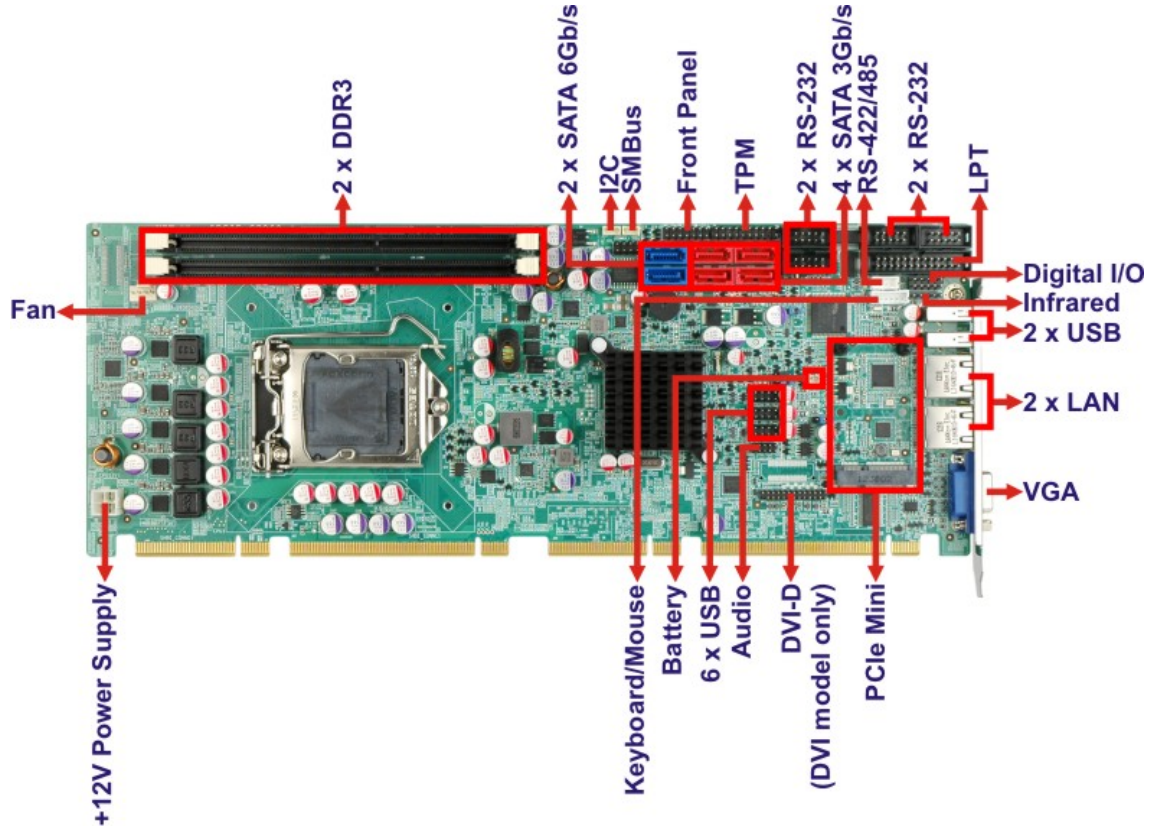

Figure 1-2: Connectors

SPCIE-C2060 PICMG 1.3 CPU Card

1.5 Dimensions

The main dimensions of the SPCIE-C2060 Series are shown in the diagram below.

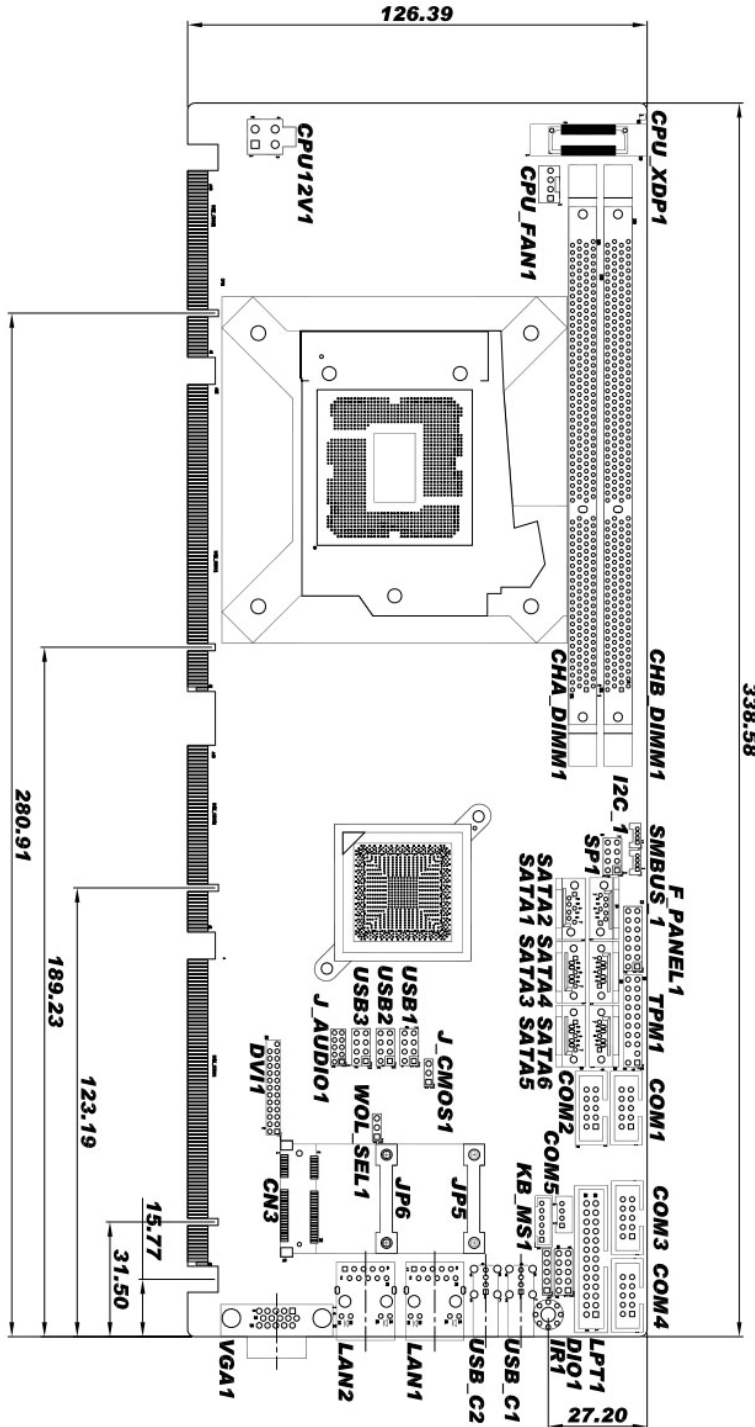

Figure 1-3: SPCIE-C2060 Series Dimensions (mm)

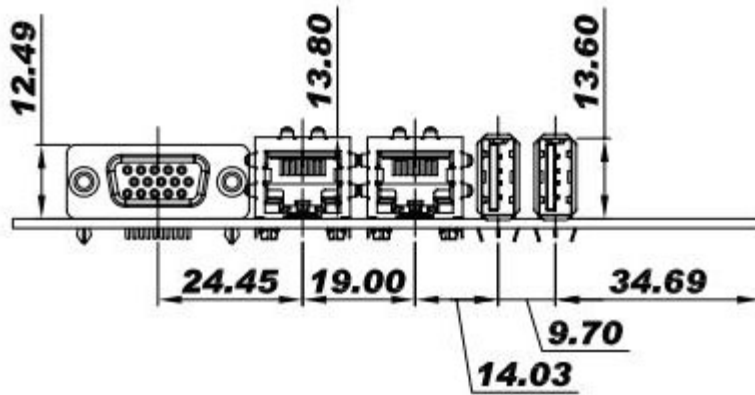

Figure 1-4: External Interface Panel Dimensions (mm)

SPCIE-C2060 PICMG 1.3 CPU Card

1.6 Data Flow

Figure 1-5 shows the data flow between the system chipset, the CPU and other components installed on the motherboard.

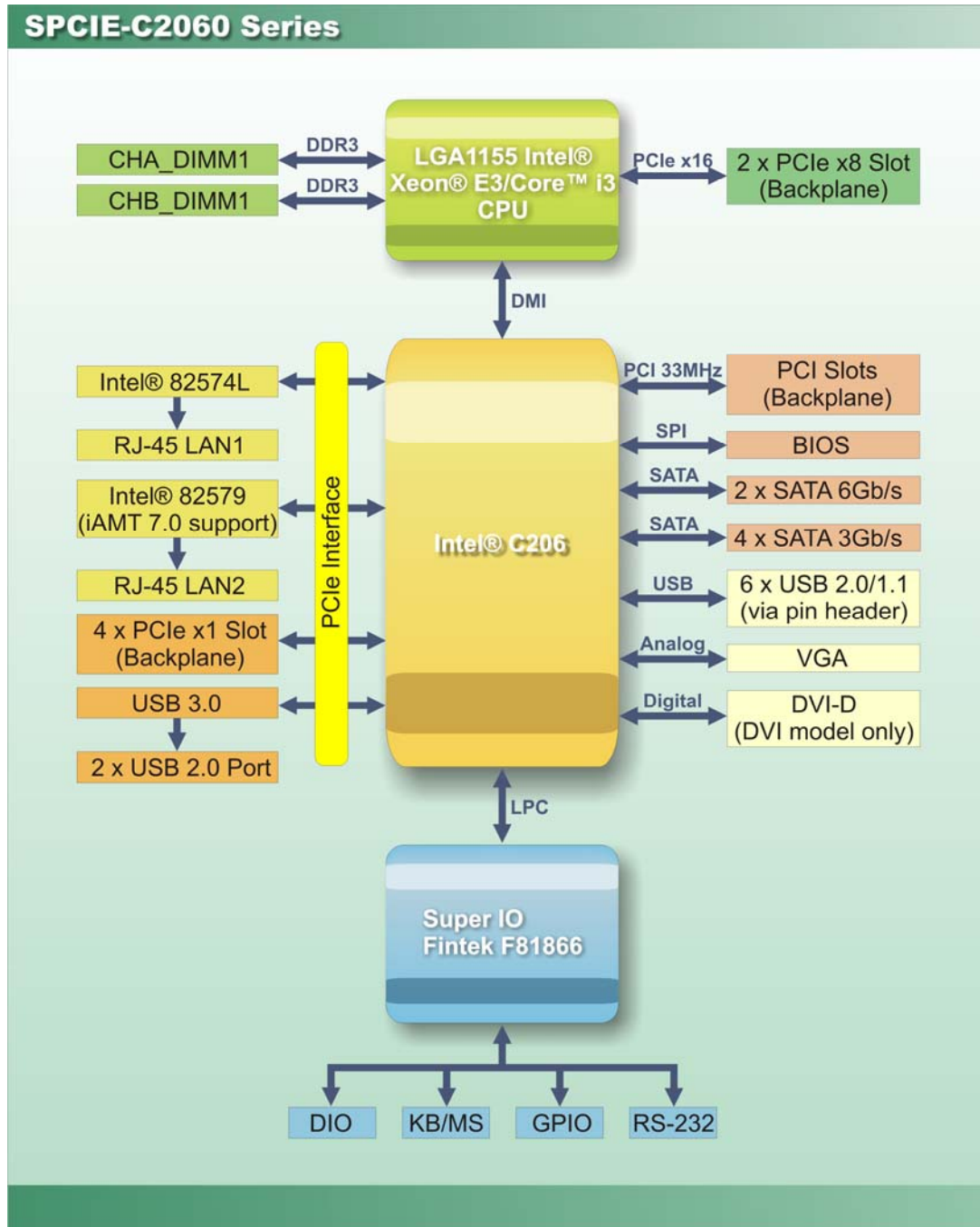

Figure 1-5: Data Flow Diagram

1.7 Technical Specifications

The SPCIE-C2060 Series technical specifications are listed below.

Specification/Model	SPCIE-C2060 Series
Form Factor	PICMG 1.3
CPU Supported	LGA1155 Intel® Xeon® E3/Core™ i3 CPU
Chipset	Intel® C206
Memory	Two 240-pin 1333/1066 MHz dual-channel ECC/non-ECC unbuffered DDR3 SDRAM DIMMs support (system max. 16.0 GB)
Graphics Engine	Supports DirectX 10.1 and OpenGL 3.0 Full MPEG2, VC1, AVC Decode
Audio	Supports IEI AC-KIT-892HD audio kit
BIOS	UEFI BIOS
Ethernet Controllers	Intel® 82574L PCIe Ethernet controller Intel® 82579 PHY with Intel® AMT 7.0 support (LAN2)
Super I/O Controller	Fintek F81866
Watchdog Timer	Software programmable supports 1~255 sec. system reset
Expansions	One PCIe Mini slot (with USB 2.0/1.1 signal) PCIe signal and PCI signal via golden fingers Supports PCIe x1/x4* slots on backplane * When installing a PCIe x4 device on the backplane, use the BIOS version supporting PCIe x4 specifications.
I/O Interface Connectors	
Audio Connector	One internal audio connector (10-pin header)
Digital I/O	8-bit, 4-bit input/4-bit output
Display Output	One VGA integrated in the Intel® C206 (rear I/O) One DVI-D integrated in the Intel® C206 (via 26-pin header to IO-KIT-001-R20 DVI-D/USB module) (DVI model only)
Ethernet	Two RJ-45 GbE ports
Fan	One 4-pin wafer connector

SPCIE-C2060 PICMG 1.3 CPU Card

Specification/Model	SPCIE-C2060 Series
Front Panel	One 14-pin header (power LED, HDD LED, speaker, power button, reset button)
I ² C	One 4-pin wafer connector
Infrared	One via 5-pin header
Keyboard/Mouse	One 6-pin wafer connector
Parallel Port	One parallel port via internal 26-pin box header
Serial ATA	Four SATA 3Gb/s connectors (support RAID 0, 1, 5, 10) Two SATA 6Gb/s connectors (support RAID 0, 1, 5, 10)
Serial Ports	Four RS-232 via internal box headers One RS-422/485 via internal 4-pin wafer connector
SMBus	One 4-pin wafer connector
TPM	One via 20-pin header
USB Ports	Two external USB 2.0 ports on rear IO Six internal USB 2.0 ports by three pin headers
Environmental and Power Specifications	
Power Supply	5V/12V, AT/ATX power supported
Power Consumption	3.3V@1.69A, 5V@3.45A, 12V@0.32A, Vcore@5.24A, 5VSB@0.17A (Intel® Xeon® E3-1275 CPU with two 1333 MHz 2GB DDR3 memory)
Operating Temperature	-10°C ~ 60°C
Storage Temperature	-20°C ~ 70°C
Storage Temperature	-20°C ~ 70°C
Humidity	5% ~ 95% (non-condensing)
Physical Specifications	
Dimensions	338 mm x 126 mm
Weight (GW/NW)	1200 g / 420 g

Table 1-2: SPCIE-C2060 Series Specifications

Chapter

2

Packing List

SPCIE-C2060 PICMG 1.3 CPU Card

2.1 Anti-static Precautions



WARNING!

Static electricity can destroy certain electronics. Make sure to follow the ESD precautions to prevent damage to the product, and injury to the user.

Make sure to adhere to the following guidelines:

- ***Wear an anti-static wristband:*** Wearing an anti-static wristband can prevent electrostatic discharge.
- ***Self-grounding:*** Touch a grounded conductor every few minutes to discharge any excess static buildup.
- ***Use an anti-static pad:*** When configuring any circuit board, place it on an anti-static mat.
- ***Only handle the edges of the PCB:*** Don't touch the surface of the motherboard. Hold the motherboard by the edges when handling.

2.2 Unpacking Precautions

When the SPCIE-C2060 Series is unpacked, please do the following:

- Follow the antistatic guidelines above.
- Make sure the packing box is facing upwards when opening.
- Make sure all the packing list items are present.







2.3 Packing List



NOTE:

If any of the components listed in the checklist below are missing, do not proceed with the installation. Contact the IEI reseller or vendor the SPCIE-C2060 Series was purchased from or contact an IEI sales representative directly by sending an email to sales@ieiworld.com.

The SPCIE-C2060 Series is shipped with the following components:

Quantity	Item and Part Number	Image
1	SPCIE-C2060 Series CPU card	
4	SATA cable (P/N: 32000-062800-RS)	
1	Dual RS-232 cable (P/N: 19800-000051-RS)	
1	Dual USB cable with bracket (P/N: 19800-003100-300-RS)	
1	Mini jumper pack	
1	DVI-D/USB kit (DVI model only) (P/N: IO-KIT-001-R20)	

SPCIE-C2060 PICMG 1.3 CPU Card









Quantity	Item and Part Number	Image
1	One Key Recovery CD	
1	Utility CD	
1	Quick Installation Guide	

Table 2-1: Packing List

2.4 Optional Items

The following are optional components which may be separately purchased:

Item and Part Number	Image
RS-422/485 cable, 200 mm (P/N: 32205-003800-300-RS)	
KB/MS cable with bracket (P/N: 19800-000075-RS)	
SATA to IDE/CF converter board (P/N: SAIDE-KIT01-R10)	
SATA power cable (P/N: 32102-000100-200-RS)	
LPT cable (P/N: 19800-000049-RS)	

Item and Part Number	Image
7.1-channel HD audio kit with Realtek ALC892 audio codec supporting dual audio stream (P/N: AC-KIT-892HD-R10)	
LGA1155/LGA1156 cooler kit (1U chassis compatible, 73W) (P/N: CF-1156A-RS-R11)	
LGA1155/LGA1156 cooler kit (1U chassis compatible, 45W) (P/N: CF-1156C-RS)	
LGA1155/LGA1156 cooler kit (1U chassis compatible, 65W) (P/N: CF-1156D-RS)	
High-performance LGA1155/LGA1156 cooler kit (95W) (P/N: CF-1156E-R11)	

Table 2-2: Optional Items

Chapter

3

Connectors

3.1 Peripheral Interface Connectors

This chapter details all the jumpers and connectors.

3.1.1 SPCIE-C2060 Series Layout

The figures below show all the connectors and jumpers.

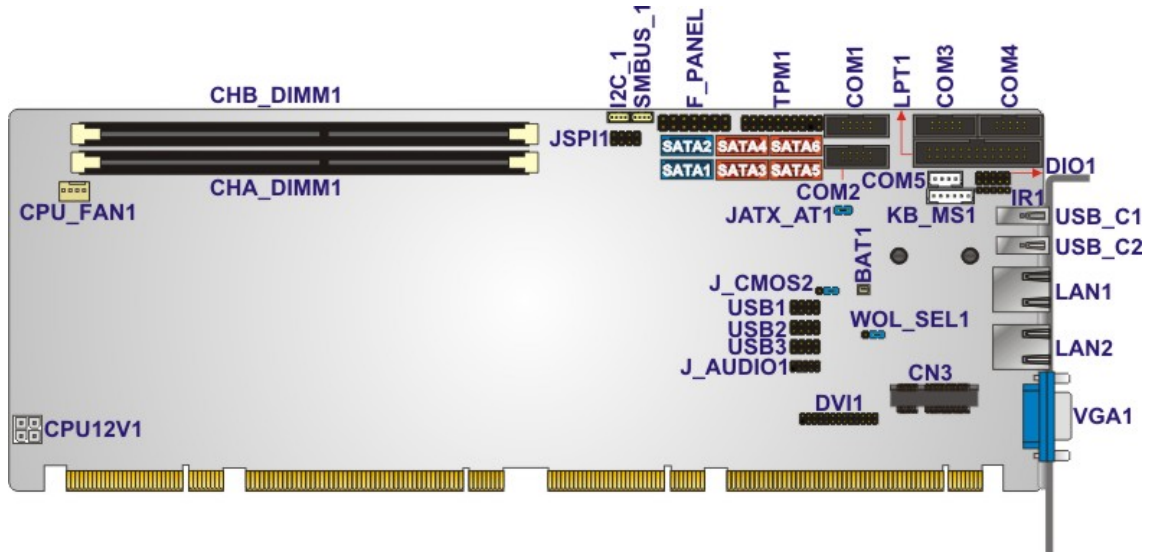

Figure 3-1: Connectors and Jumpers

3.1.2 Peripheral Interface Connectors

The table below lists all the connectors on the board.

Connector	Type	Label
+12V ATX power supply connector	4-pin Molex power connector	CPU12V1
Audio kit connector	10-pin header	J_AUDIO1
Battery connector	2-pin wafer	BT2
DDR3 DIMM sockets	240-pin socket	CHA_DIMM1 CHB_DIMM1
Digital I/O connector	10-pin header	DIO1
DVI-D connector (DVI model only)	26-pin header	DVI1

SPCIE-C2060 PICMG 1.3 CPU Card

Connector	Type	Label
Fan connector (CPU)	4-pin wafer	CPU_FAN1
Front panel connector	14-pin header	F_PANEL1
I ² C connector	4-pin wafer	I2C_1
Infrared connector	5-pin header	IR1
Keyboard and mouse connector	6-pin wafer	KB_MS1
Parallel port connector	26-pin box header	LPT1
PCIe Mini slot	PCIe Mini	CN3
SATA 3Gb/s drive connector	7-pin SATA connector	SATA3, SATA4, SATA5, SATA6
SATA 6Gb/s drive connector	7-pin SATA connector	SATA1, SATA2
Serial port, RS-422/485	4-pin wafer	COM5
Serial port, RS-232	10-pin box header	COM1, COM2, COM3, COM4
SMBus connector	4-pin wafer	SMBUS_1
SPI ROM connector	8-pin header	JSPI1
TPM connector	20-pin header	TPM1
USB connectors	8-pin header	USB1, USB2, USB3

Table 3-1: Peripheral Interface Connectors

3.1.3 External Interface Panel Connectors

The table below lists the connectors on the external I/O panel.

Connector	Type	Label
Ethernet connector	RJ-45	LAN1
Ethernet connector	RJ-45	LAN2
USB port	USB	USB_C1
USB port	USB	USB_C2

Connector	Type	Label
VGA connector	15-pin female	VGA1

Table 3-2: Rear Panel Connectors

3.2 Internal Peripheral Connectors

The section describes all of the connectors on the SPCIE-C2060 Series.

3.2.1 12V Power Connector

- CN Label:** CPU12V1
- CN Type:** 4-pin Molex power connector
- CN Location:** See **Figure 3-2**
- CN Pinouts:** See **Table 3-3**

The connector supports the 12V power supply.

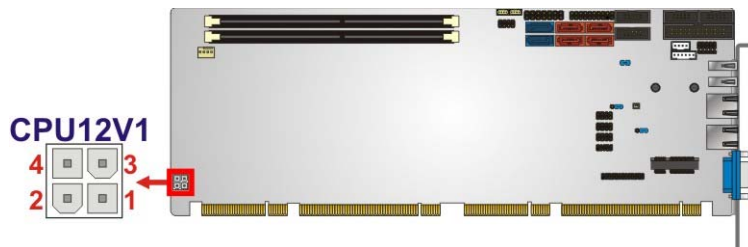

Figure 3-2: ATX Power Connector Pinout Location

Pin	Description	Pin	Description
1	GND	2	GND
3	+12V	4	+12V

Table 3-3: ATX Power Connector Pinouts

3.2.2 Audio Kit Connector

- CN Label:** J_AUDIO1
- CN Type:** 10-pin header

SPCIE-C2060 PICMG 1.3 CPU Card

CN Location: See Figure 3-3

CN Pinouts: See Table 3-4

This connector connects to an external audio kit.

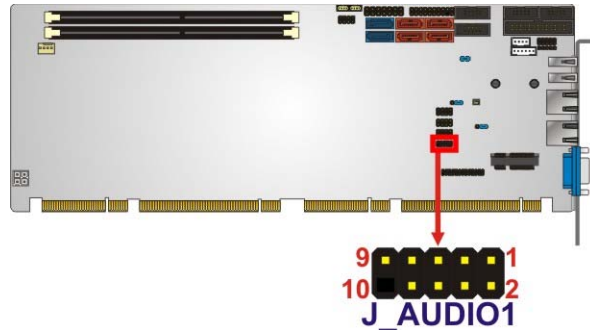

Figure 3-3: Audio Connector Location

PIN NO.	DESCRIPTION	PIN NO.	DESCRIPTION
1	ACZ_SYNC	2	ACZ_BITCLK
3	ACZ_SDOUT	4	ACZ_PCBEEP
5	ACZ_SDIN	6	ACZ_RST#
7	ACZ_VCC	8	ACZ_GND
9	ACZ_12V	10	ACZ_GND

Table 3-4: Audio Connector Pinouts

3.2.3 Battery Connector



CAUTION:

Risk of explosion if battery is replaced by an incorrect type. Only certified engineers should replace the on-board battery.

Dispose of used batteries according to instructions and local regulations.

CN Label: BAT1

CN Type: 2-pin wafer

CN Location: See **Figure 3-4**

CN Pinouts: See **Table 3-5**

This is connected to the system battery. The battery provides power to the system clock to retain the time when power is turned off.

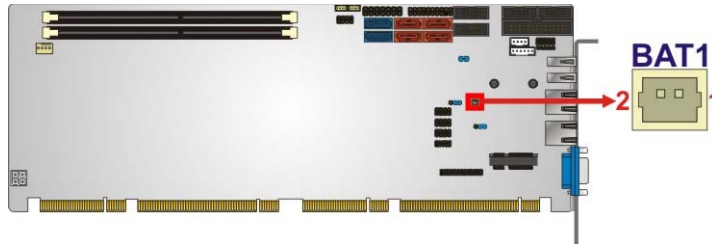

Figure 3-4: Battery Connector Location

Pin	Description
1	GND
2	Battery+

Table 3-5: Battery Connector (BT2) Pinouts

3.2.4 DDR3 DIMM Slots

CN Label: CHA_DIMM1, CHB_DIMM1

CN Type: DDR3 DIMM slot

CN Location: See **Figure 3-5**

The DIMM slots are for DDR3 DIMM memory modules.

SPCIE-C2060 PICMG 1.3 CPU Card

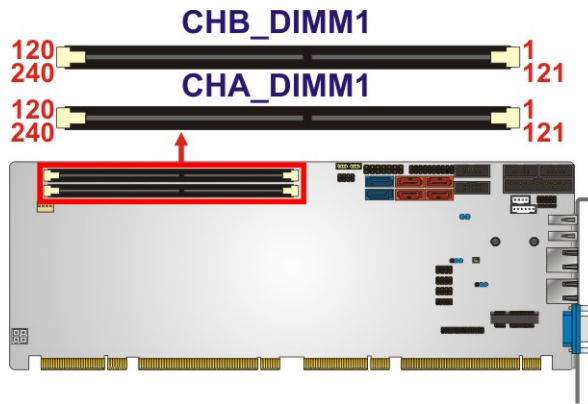

Figure 3-5: DDR3 DIMM Slot Locations

3.2.5 Digital I/O Connector

- CN Label:** DIO1
- CN Type:** 10-pin header
- CN Location:** See Figure 3-6
- CN Pinouts:** See Table 3-6

The digital I/O connector provides programmable input and output for external devices. The digital I/O provides 4-bit output and 4-bit input.

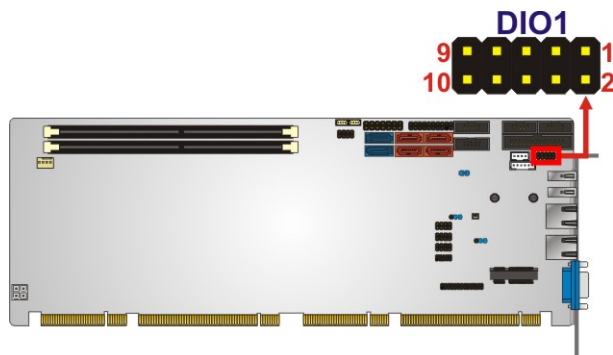

Figure 3-6: Digital I/O Connector Location

PIN NO.	DESCRIPTION	PIN NO.	DESCRIPTION
1	GND	2	VCC
3	Output 3	4	Output 2
5	Output 1	6	Output 0

PIN NO.	DESCRIPTION	PIN NO.	DESCRIPTION
7	Input 3	8	Input 2
9	Input 1	10	Input 0

Table 3-6: Digital I/O Connector Pinouts

3.2.6 DVI-D Connector (DVI Model Only)

- CN Label:** DVI1
- CN Type:** 26-pin header
- CN Location:** See **Figure 3-7**
- CN Pinouts:** See **Table 3-7**

The DVI-D connector connects to a monitor that supports DVI video input via the DVI-D/USB kit.

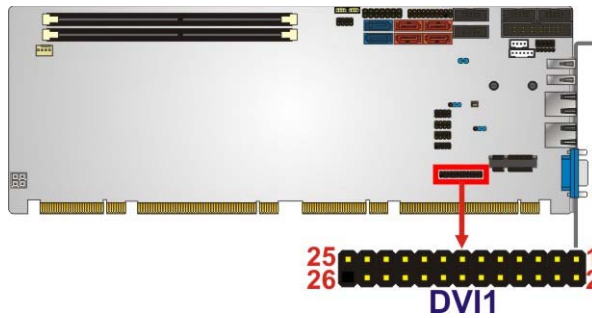

Figure 3-7: DVI-D Connector Location

Pin	Description	Pin	Description
1	Data 2-	2	Data 2+
3	GND	4	NC
5	NC	6	DDC Clock
7	DDC Data	8	NC
9	Data 1-	10	Data 1+
11	GND	12	NC
13	NC	14	VCC
15	GND	16	Hot Plug Detect
17	Data 0-	18	Data 0+

SPCIE-C2060 PICMG 1.3 CPU Card

Pin	Description	Pin	Description
19	GND	20	NC
21	NC	22	GND
23	Clock +	24	Clock -
25	GND	26	NC

Table 3-7: DVI-D Connector Pinouts

3.2.7 Fan Connector (CPU)

- CN Label:** CPU_FAN1
- CN Type:** 4-pin wafer
- CN Location:** See **Figure 3-8**
- CN Pinouts:** See **Table 3-8**

The fan connector attaches to a CPU cooling fan.

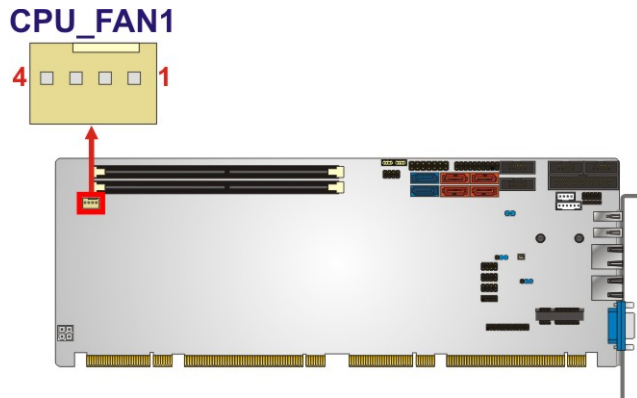

Figure 3-8: CPU Fan Connector Location

PIN NO.	DESCRIPTION
1	GND
2	+12 V
3	Rotation Signal
4	PWM Control Signal

Table 3-8: CPU Fan Connector Pinouts

3.2.8 Front Panel Connector

- CN Label:** F_PANEL1
- CN Type:** 14-pin header
- CN Location:** See **Figure 3-9**
- CN Pinouts:** See **Table 3-9**

The front panel connector connects to the indicator LEDs and buttons on the computer's front panel.

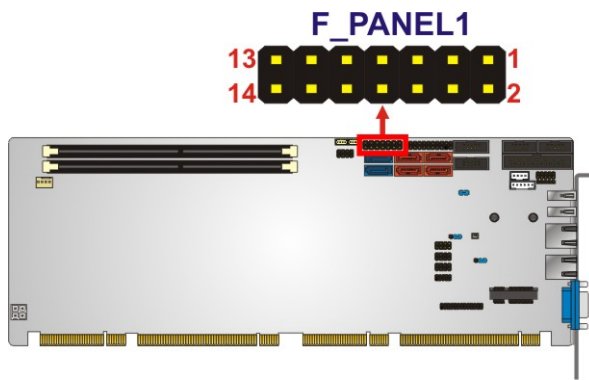

Figure 3-9: Front Panel Connector Location

FUNCTION	PIN	DESCRIPTION	FUNCTION	PIN	DESCRIPTION
Power LED	1	+5V	Speaker	2	+5V
	3	N/C		4	N/C
	5	GROUND		6	N/C
Power Button	7	PWR_BTN+	8	Speaker	
	9	PWR_BTN-	Reset	10	N/C
HDD LED	11	+5V		12	RESET-
	13	HDD_LED-		14	GROUND

Table 3-9: Front Panel Connector Pinouts

SPCIE-C2060 PICMG 1.3 CPU Card

3.2.9 I²C Connector

- CN Label:** I2C_1
- CN Type:** 4-pin wafer
- CN Location:** See **Figure 3-10**
- CN Pinouts:** See **Table 3-10**

The I²C connector is for system debug.

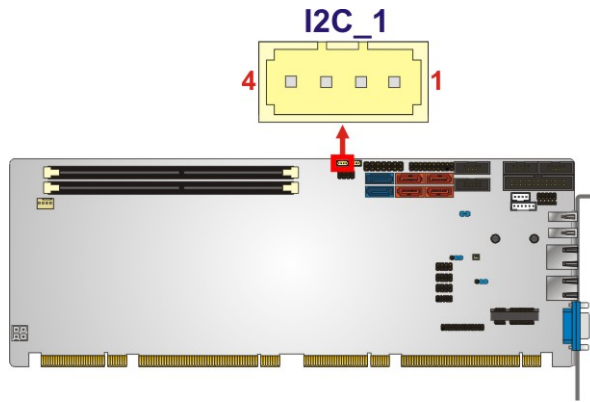

Figure 3-10: I²C Connector Location

Pin	Description
1	GND
2	PCH_GP38_PU
3	PCH_GP39_PU
4	+5VS

Table 3-10: I²C Connector Pinouts

3.2.10 Infrared Interface Connector

- CN Label:** IR1
- CN Type:** 5-pin header
- CN Location:** See **Figure 3-11**
- CN Pinouts:** See **Table 3-11**

The infrared connector attaches to an infrared receiver for use with remote controls.

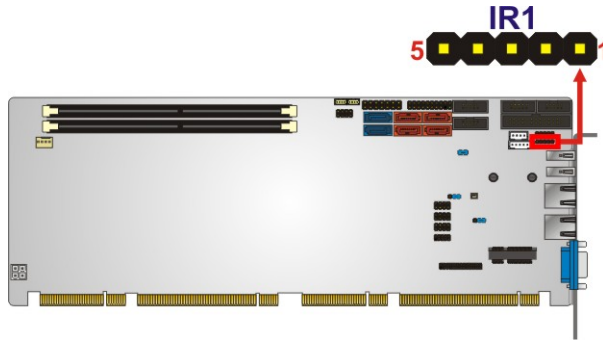

Figure 3-11: Infrared Connector Location

Pin	Description
1	VCC
2	NC
3	IR-RX
4	GND
5	IR-TX

Table 3-11: Infrared Connector Pinouts

3.2.11 Keyboard/Mouse Connector

- CN Label:** KB_MS1
- CN Type:** 6-pin wafer
- CN Location:** See **Figure 3-12**
- CN Pinouts:** See **Table 3-12**

The keyboard/mouse connector connects to a PS/2 Y-cable that can be connected to a PS/2 keyboard and mouse.

SPCIE-C2060 PICMG 1.3 CPU Card

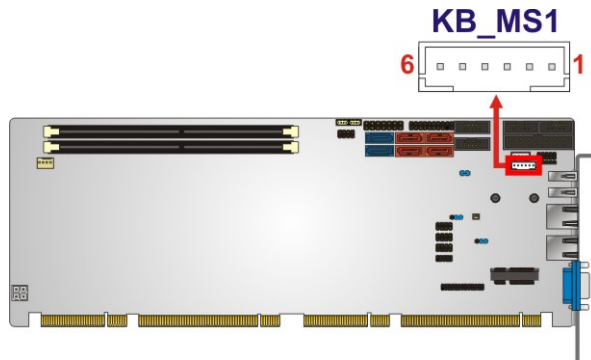

Figure 3-12: Keyboard/Mouse Connector Location

Pin	Description
1	+5 VCC
2	Mouse Data
3	Mouse Clock
4	Keyboard Data
5	Keyboard Clock
6	GROUND

Table 3-12: Keyboard/Mouse Connector Pinouts

3.2.12 Parallel Port Connector

- CN Label:** LPT1
- CN Type:** 26-pin box header
- CN Location:** See **Figure 3-13**
- CN Pinouts:** See **Table 3-13**

The parallel port connector connects to a parallel port connector interface or some other parallel port device such as a printer.

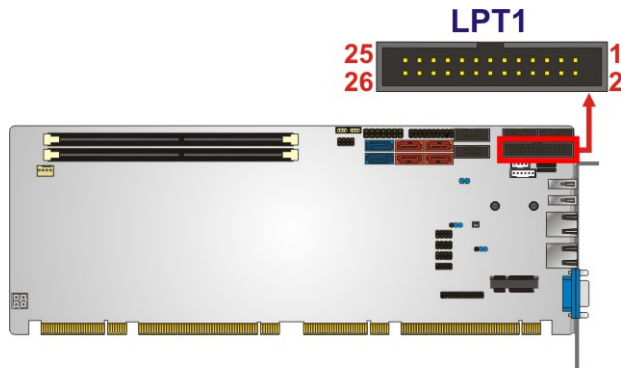

Figure 3-13: Parallel Port Connector Location

Pin	Description	Pin	Description
1	STROBE#	2	DATA0
3	DATA1	4	DATA2
5	DATA3	6	DATA4
7	DATA5	8	DATA6
9	DATA7	10	ACKNOWLEDGE#
11	BUSY	12	PAPER EMPTY
13	PRINTER SELECT	14	AUTO FORM FEED #
15	ERROR#	16	INITIALIZE#
17	PRINTER SELECT LN#	18	GND
19	GND	20	GND
21	GND	22	GND
23	GND	24	GND
25	GND		

Table 3-13: Parallel Port Connector Pinouts

3.2.13 PCIe Mini Card Slot

- CN Label:** CN3
- CN Type:** PCIe Mini card slot
- CN Location:** See **Figure 3-14**
- CN Pinouts:** See **Table 3-14**

SPCIE-C2060 PICMG 1.3 CPU Card

The PCIe Mini card slot is for installing a PCIe Mini expansion card.

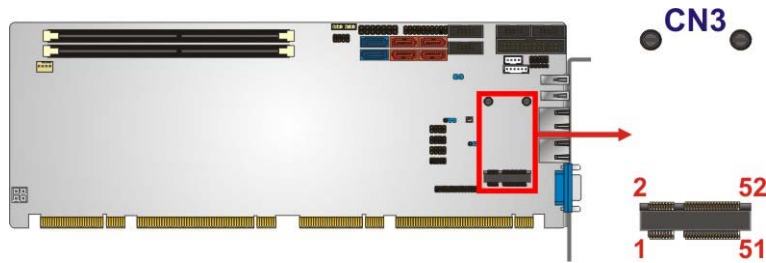

Figure 3-14: PCIe Mini Card Slot Location

Pin	Description	Pin	Description
1	PCIE_WAKE#	2	VCC3
3	NC	4	GND
5	NC	6	1.5V
7	CLKREQ#	8	LFRAME#
9	GND	10	LAD3
11	CLK-	12	LAD2
13	CLK+	14	LAD1
15	GND	16	LAD0
17	PCIRST#	18	GND
19	LPC	20	VCC3
21	GND	22	PCIRST#
23	PERN2	24	3VDual
25	PERP2	26	GND
27	GND	28	1.5V
29	GND	30	SMBCLK
31	PETN2	32	SMBDATA
33	PETP2	34	GND
35	GND	36	USB-
37	NC	38	USB+
39	NC	40	GND
41	NC	42	NC
43	NC	44	RF_LINK#
45	NC	46	BLUELED#

Pin	Description	Pin	Description
47	NC	48	1.5V
49	NC	50	GND
51	NC	52	VCC3

Table 3-14: PCIe Mini Card Slot Pinouts

3.2.14 SATA 3Gb/s Drive Connector

CN Label: SATA3, SATA4, SATA5, SATA6

CN Type: 7-pin SATA drive connector

CN Location: See Figure 3-15

CN Pinouts: See Table 3-15

The SATA drive connectors can be connected to SATA drives and support up to 3Gb/s data transfer rate.

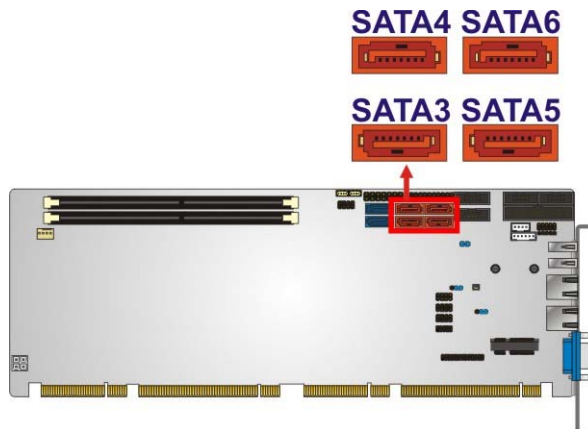

Figure 3-15: SATA 3Gb/s Drive Connector Location

Pin	Description	Pin	Description
1	GND	2	TX+
3	TX-	4	GND
5	RX-	6	RX+
7	GND		

Table 3-15: SATA 3Gb/s Drive Connector Pinouts

SPCIE-C2060 PICMG 1.3 CPU Card

3.2.15 SATA 6Gb/s Drive Connector

- CN Label:** SATA1, SATA2
- CN Type:** 7-pin SATA drive connector
- CN Location:** See **Figure 3-16**
- CN Pinouts:** See **Table 3-16**

The SATA drive connectors can be connected to SATA drives and support up to 6Gb/s data transfer rate.

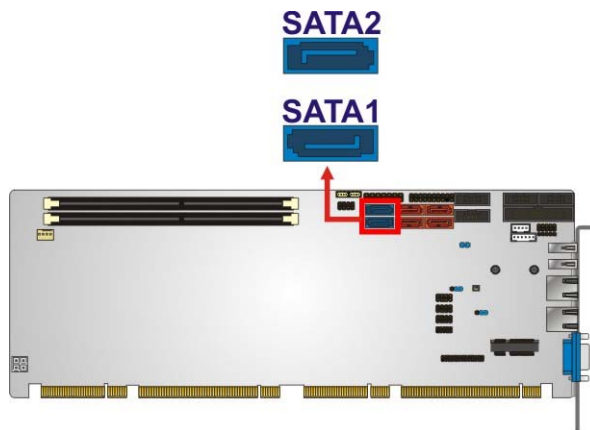

Figure 3-16: SATA 6Gb/s Drive Connector Location

Pin	Description	Pin	Description
1	GND	2	TX+
3	TX-	4	GND
5	RX-	6	RX+
7	GND		

Table 3-16: SATA 6Gb/s Drive Connector Pinouts

3.2.16 Serial Port Connectors, RS-232

- CN Label:** COM1, COM2, COM3, COM4
- CN Type:** 10-pin box header
- CN Location:** See **Figure 3-17**
- CN Pinouts:** See **Table 3-17**

Each of these connectors provides RS-232 connections.

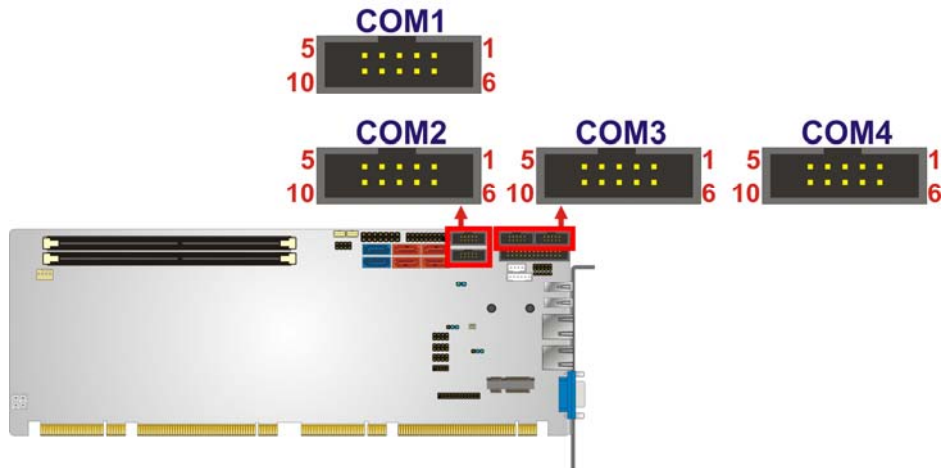

Figure 3-17: Serial Port Connector Location

Pin	Description	Pin	Description
1	Data Carrier Direct (DCD)	2	Receive Data (RXD)
3	Transmit Data (TXD)	4	Data Terminal Ready (DTR)
5	Ground (GND)	6	Data Set Ready (DSR)
7	Request To Send (RTS)	8	Clear To Send (CTS)
9	Ring Indicator (RI)	10	N/C

Table 3-17: Serial Port Connector Pinouts

3.2.17 Serial Port Connector, RS-422/485

- CN Label:** COM5
- CN Type:** 4-pin wafer
- CN Location:** See **Figure 3-18**
- CN Pinouts:** See **Table 3-18**

This connector provides RS-422 or RS-485 communications.

SPCIE-C2060 PICMG 1.3 CPU Card

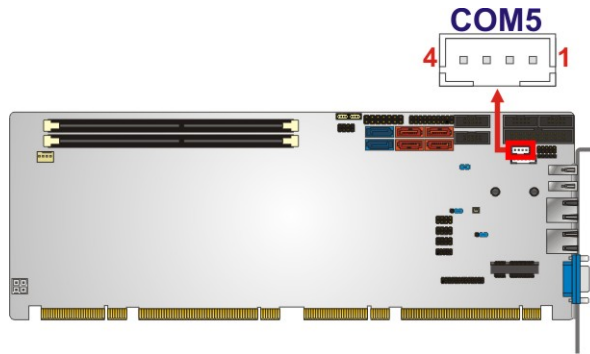

Figure 3-18: RS-422/485 Connector Location

PIN NO.	DESCRIPTION	PIN NO.	DESCRIPTION
1	RXD422-	3	TXD422+/TXD485+
2	RXD422+	4	TXD422-/TXD485-

Table 3-18: RS-422/485 Connector Pinouts

Use the optional RS-422/485 cable to connect to a serial device. The pinouts of the DB-9 connector are listed below.

RS-422 Pinouts	RS-485 Pinouts

Table 3-19: DB-9 RS-422/485 Pinouts

3.2.18 SMBus Connector

- CN Label:** SMBUS_1
- CN Type:** 4-pin wafer
- CN Location:** See **Figure 3-19**
- CN Pinouts:** See **Table 3-20**

The SMBus (System Management Bus) connector provides low-speed system management communications.

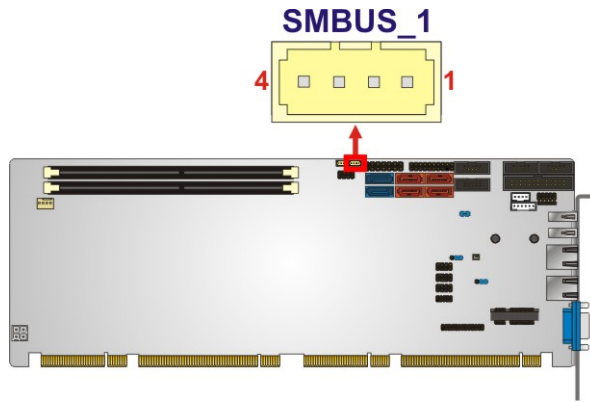

Figure 3-19: SMBus Connector Location

Pin	Description
1	GND
2	SMB_DATA
3	SMB_CLK
4	+V5S

Table 3-20: SMBus Connector Pinouts

3.2.19 SPI ROM Connector

- CN Label:** JSPI1
- CN Type:** 8-pin header
- CN Location:** See **Figure 3-20**
- CN Pinouts:** See **Table 3-21**

The SPI connector is used to flash the BIOS.

SPCIE-C2060 PICMG 1.3 CPU Card

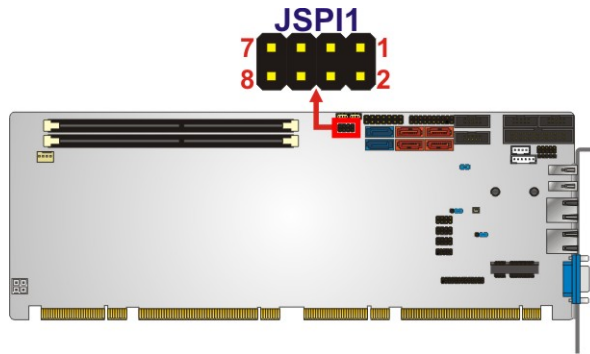

Figure 3-20: SPI Connector Location

PIN NO.	DESCRIPTION	PIN NO.	DESCRIPTION
1	+3.3V	2	GND
3	SPI_CS0	4	SPI_CLK
5	SPI_S00	6	SPI_SI
7	NC	8	NC

Table 3-21: SPI Connector Pinouts

3.2.20 TPM Connector

- CN Label:** TPM1
- CN Type:** 20-pin header
- CN Location:** See **Figure 3-21**
- CN Pinouts:** See **Table 3-22**

The TPM connector connects to a TPM module.

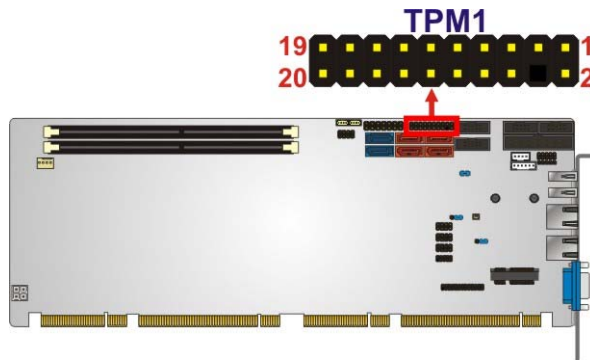

Figure 3-21: TPM Connector Location

PIN NO.	DESCRIPTION	PIN NO.	DESCRIPTION
1	CLK	2	GND
3	ERAME#	4	NC
5	RESRT#	6	+5V
7	AD3	8	AD2
9	+3V	10	AD1
11	AD0	12	GND
13	SMB_CLK	14	SMB_DATA
15	SB3V	16	SERIRO
17	GND	18	CLKRUN#
19	PM_SUS_STAT#	20	DRQ#

Table 3-22: TPM Connector Pinouts

3.2.21 USB Connectors

CN Label: USB1, USB2, USB3

CN Type: 8-pin header

CN Location: See **Figure 3-22**

CN Pinouts: See **Table 3-23**

The USB connectors connect to USB devices. Each pin header provides two USB ports.

SPCIE-C2060 PICMG 1.3 CPU Card

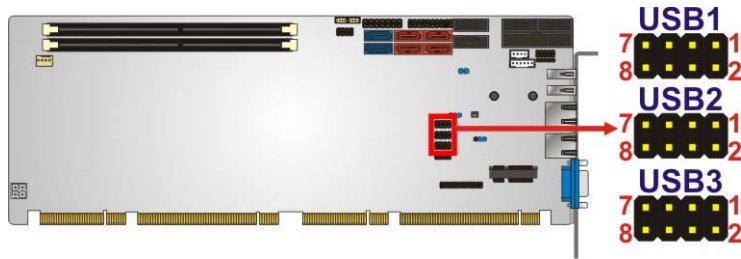

Figure 3-22: USB Connector Pinout Locations

PIN NO.	DESCRIPTION	PIN NO.	DESCRIPTION
1	VCC	2	GND
3	DATA-	4	DATA+
5	DATA+	6	DATA-
7	GND	8	VCC

Table 3-23: USB Port Connector Pinouts

3.3 External Peripheral Interface Connector Panel

The figure below shows the external peripheral interface connector (EPIC) panel. The EPIC panel consists of the following:

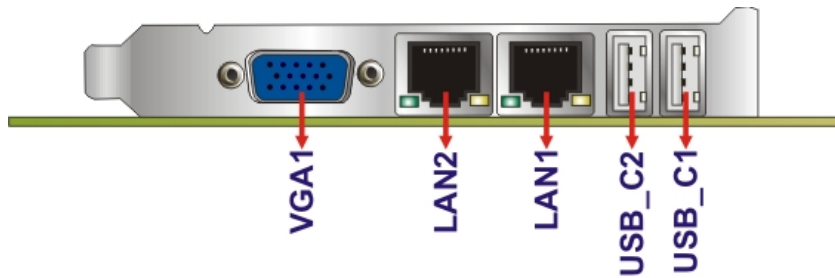

Figure 3-23: External Peripheral Interface Connector

3.3.1 Ethernet Connectors

- CN Label:** LAN1 and LAN2
- CN Type:** RJ-45
- CN Location:** See Figure 3-23
- CN Pinouts:** See Figure 3-24 and Table 3-24

The SPCIE-C2060 Series is equipped with two built-in RJ-45 Ethernet controllers. Each controller can connect to the LAN through one RJ-45 LAN connector.

Pin	Description	Pin	Description
1	MDIA3-	5	MDIA2+
2	MDIA3+	6	MDIA1+
3	MDIA1-	7	MDIA0-
4	MDIA2-	8	MDIA0+

Table 3-24: LAN Pinouts

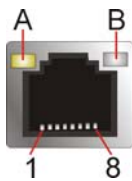

Figure 3-24: Ethernet Connector

LED	Description	LED	Description
A	on: linked blinking: data is being sent/received	B	off: 10 Mb/s green: 100 Mb/s orange: 1000 Mb/s

Table 3-25: Connector LEDs

3.3.2 USB Connectors

CN Label: USB_C1 and USB_C2

CN Type: USB port

CN Location: See **Figure 3-23**

CN Pinouts: See **Table 3-26**

The SPCIE-C2060 Series has two external USB 2.0 ports. The ports connect to both USB 2.0 and USB 1.1 devices.

Pin	Description
1	VCC
2	DATA-

SPCIE-C2060 PICMG 1.3 CPU Card

Pin	Description
3	DATA+
4	GROUND

Table 3-26: USB Port Pinouts

3.3.3 VGA Connector

- CN Label:** VGA1
- CN Type:** 15-pin Female
- CN Location:** See **Figure 3-23**
- CN Pinouts:** See **Figure 3-25** and **Table 3-27**

The VGA connector connects to a monitor that accepts a standard VGA input.

Pin	Description	Pin	Description
1	RED	2	GREEN
3	BLUE	4	NC
5	GND	6	GND
7	GND	8	GND
9	VGAVCC	10	GND
11	NC	12	DCCDAT
13	HSYNC	14	VSYNC
15	DDCCLK		

Table 3-27: VGA Connector Pinouts

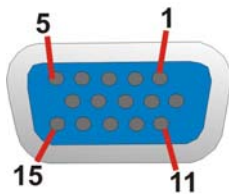

Figure 3-25: VGA Connector

Chapter

4

Installation

SPCIE-C2060 PICMG 1.3 CPU Card

4.1 Anti-static Precautions



WARNING:

Failure to take ESD precautions during the installation of the SPCIE-C2060 Series may result in permanent damage to the SPCIE-C2060 Series and severe injury to the user.

Electrostatic discharge (ESD) can cause serious damage to electronic components, including the SPCIE-C2060 Series. Dry climates are especially susceptible to ESD. It is therefore critical that whenever the SPCIE-C2060 Series or any other electrical component is handled, the following anti-static precautions are strictly adhered to.

- ***Wear an anti-static wristband:*** - Wearing a simple anti-static wristband can help to prevent ESD from damaging the board.
- ***Self-grounding:***- Before handling the board touch any grounded conducting material. During the time the board is handled, frequently touch any conducting materials that are connected to the ground.
- ***Use an anti-static pad:*** When configuring the SPCIE-C2060 Series, place it on an anti-static pad. This reduces the possibility of ESD damaging the SPCIE-C2060 Series.
- ***Only handle the edges of the PCB:-:*** When handling the PCB, hold the PCB by the edges.

4.2 Installation Considerations



NOTE:

The following installation notices and installation considerations should be read and understood before installation. All installation notices must be strictly adhered to. Failing to adhere to these precautions may lead to severe damage and injury to the person performing the installation.

**WARNING:**

The installation instructions described in this manual should be carefully followed in order to prevent damage to the components and injury to the user.

Before and during the installation please **DO** the following:

- Read the user manual:
 - The user manual provides a complete description of the SPCIE-C2060 Series installation instructions and configuration options.
- Wear an electrostatic discharge cuff (ESD):
 - Electronic components are easily damaged by ESD. Wearing an ESD cuff removes ESD from the body and helps prevent ESD damage.
- Place the SPCIE-C2060 Series on an antistatic pad:
 - When installing or configuring the motherboard, place it on an antistatic pad. This helps to prevent potential ESD damage.
- Turn all power to the SPCIE-C2060 Series off:
 - When working with the SPCIE-C2060 Series, make sure that it is disconnected from all power supplies and that no electricity is being fed into the system.

Before and during the installation of the SPCIE-C2060 Series **DO NOT:**

- Remove any of the stickers on the PCB board. These stickers are required for warranty validation.
- Use the product before verifying all the cables and power connectors are properly connected.
- Allow screws to come in contact with the PCB circuit, connector pins, or its components.

SPCIE-C2060 PICMG 1.3 CPU Card

4.2.1 Socket LGA1155 CPU Installation



WARNING:

CPUs are expensive and sensitive components. When installing the CPU please be careful not to damage it in anyway. Make sure the CPU is installed properly and ensure the correct cooling kit is properly installed.

DO NOT touch the pins at the bottom of the CPU. When handling the CPU, only hold it on the sides.

To install the CPU, follow the steps below.

Step 1: **Disengage the load lever** by pressing the lever down and slightly outward to clear the retention tab. Fully open the lever. See **Figure 4-1**.

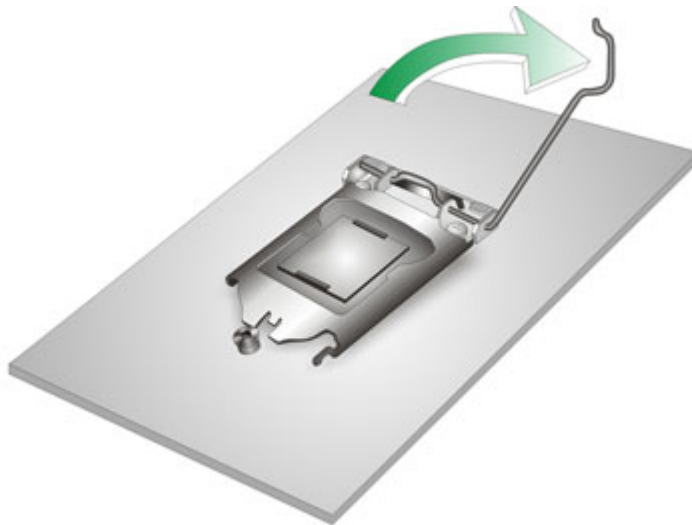

Figure 4-1: Disengage the CPU Socket Load Lever

Step 2: **Open the socket and remove the protective cover.** The black protective cover can be removed by pulling up on the tab labeled "Remove". See **Figure 4-2**.

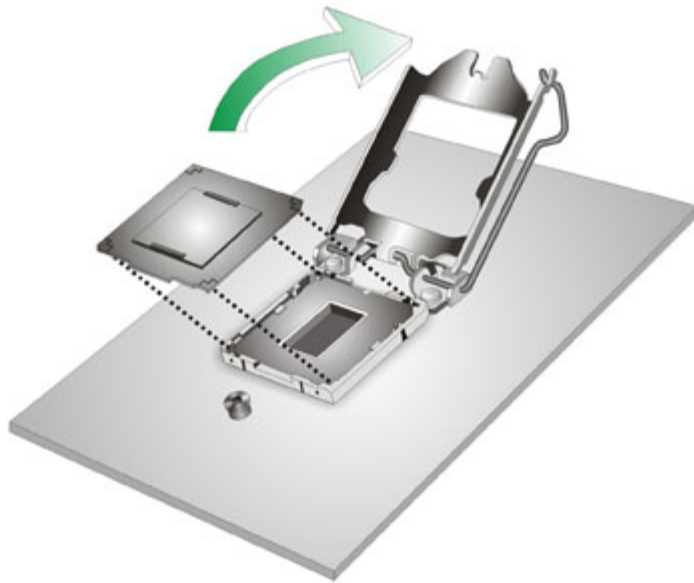

Figure 4-2: Remove Protective Cover

- Step 3: Inspect the CPU socket.** Make sure there are no bent pins and make sure the socket contacts are free of foreign material. If any debris is found, remove it with compressed air.
- Step 4: Orientate the CPU properly.** The contact array should be facing the CPU socket.
- Step 5: Correctly position the CPU.** Match the Pin 1 mark with the cut edge on the CPU socket.
- Step 6: Align the CPU pins.** Locate pin 1 and the two orientation notches on the CPU. Carefully match the two orientation notches on the CPU with the socket alignment keys.
- Step 7: Insert the CPU.** Gently insert the CPU into the socket. If the CPU pins are properly aligned, the CPU should slide into the CPU socket smoothly. See **Figure 4-3**.

SPCIE-C2060 PICMG 1.3 CPU Card

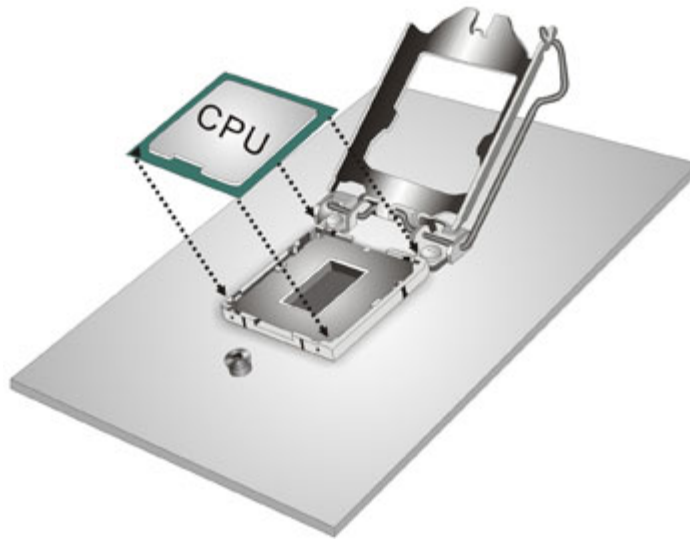

Figure 4-3: Insert the Socket LGA1155 CPU

Step 8: Close the CPU socket. Close the load plate and pull the load lever back a little to have the load plate be able to secure to the knob. Engage the load lever by pushing it back to its original position (**Figure 4-4**). There will be some resistance, but will not require extreme pressure.

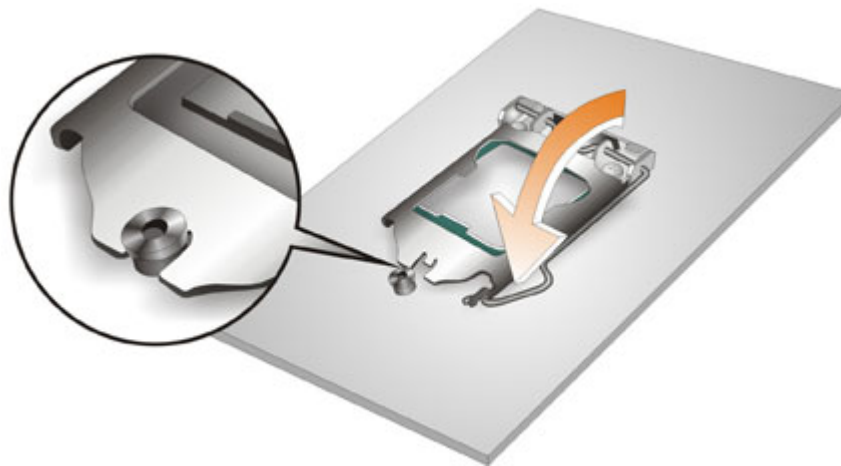

Figure 4-4: Close the Socket LGA1155

Step 9: Connect the 12 V power to the board. Connect the 12 V power from the power supply to the board.

4.2.2 Socket LGA1155 Cooling Kit Installation

The cooling kit can be bought from IEI. The cooling kit has a heatsink and fan.



WARNING:

Do not wipe off (accidentally or otherwise) the pre-sprayed layer of thermal paste on the bottom of the heat sink. The thermal paste between the CPU and the heat sink is important for optimum heat dissipation.

To install the cooling kit, follow the instructions below.

Step 1: A cooling kit bracket is pre-installed on the rear of the motherboard. See **Figure 4-5**.

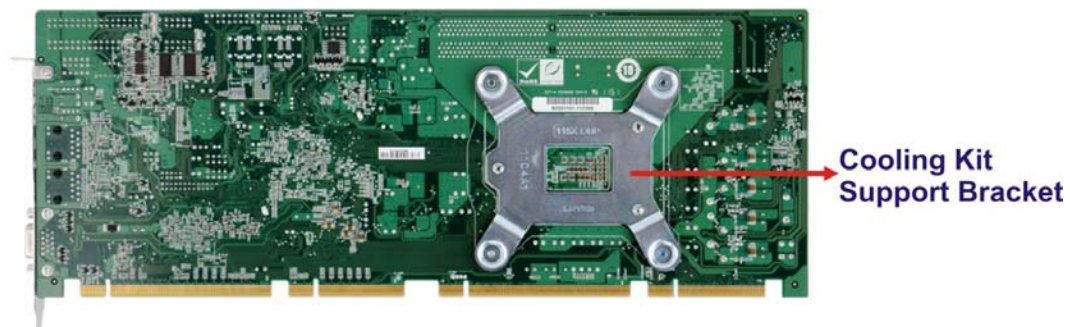

Figure 4-5: Cooling Kit Support Bracket

- Step 2:** Place the cooling kit onto the socket LGA1155 CPU. Make sure the CPU cable can be properly routed when the cooling kit is installed.
- Step 3:** Mount the cooling kit. Gently place the cooling kit on top of the CPU. Make sure the four threaded screws on the corners of the cooling kit properly pass through the holes of the cooling kit bracket.
- Step 4:** Secure the cooling kit by fastening the four retention screws of the cooling kit.

SPCIE-C2060 PICMG 1.3 CPU Card

Step 5: Connect the fan cable. Connect the cooling kit fan cable to the fan connector on the SPCIE-C2060 Series. Carefully route the cable and avoid heat generating chips and fan blades.

4.2.3 DIMM Installation

To install a DIMM, please follow the steps below and refer to **Figure 4-6**.

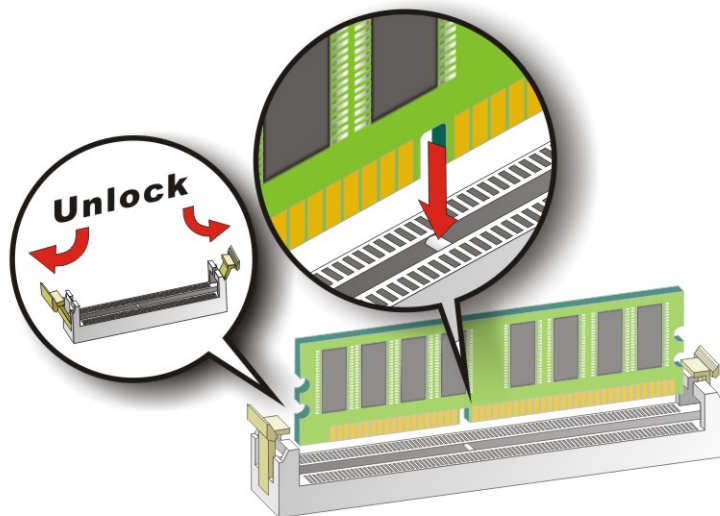

Figure 4-6: DIMM Installation

- Step 1: Open the DIMM socket handles.** Open the two handles outwards as far as they can. See **Figure 4-6**.
- Step 2: Align the DIMM with the socket.** Align the DIMM so the notch on the memory lines up with the notch on the memory socket. See **Figure 4-6**.
- Step 3: Insert the DIMM.** Once aligned, press down until the DIMM is properly seated. Clip the two handles into place. See **Figure 4-6**.
- Step 4: Removing a DIMM.** To remove a DIMM, push both handles outward. The memory module is ejected by a mechanism in the socket.

4.3 Jumper Settings



NOTE:

A jumper is a metal bridge used to close an electrical circuit. It consists of two or three metal pins and a small metal clip (often protected by a plastic cover) that slides over the pins to connect them. To CLOSE/SHORT a jumper means connecting the pins of the jumper with the plastic clip and to OPEN a jumper means removing the plastic clip from a jumper.

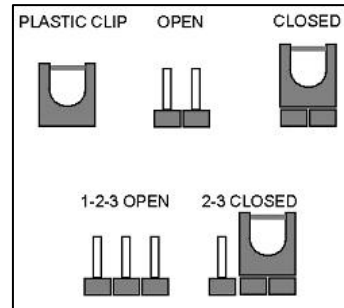

The hardware jumpers must be set before installation. Jumpers are shown in **Table 4-1**.

Description	Label	Type
AT/ATX power select	JATX_AT1	2-pin header
Clear CMOS jumper	J_CMOS1	3-pin header
Wake-on LAN	WOL_SEL1	3-pin header

Table 4-1: Jumpers

4.3.1 AT/ATX Power Select Jumper

- Jumper Label:** JATX_AT1
- Jumper Type:** 2-pin header
- Jumper Settings:** See **Table 4-2**
- Jumper Location:** See **Figure 4-7**

The AT/ATX Power Select jumper specifies the systems power mode as AT or ATX.

SPCIE-C2060 PICMG 1.3 CPU Card

Setting	Description
Closed	ATX power (Default)
Open	AT power

Table 4-2: AT/ATX Power Mode Jumper Settings

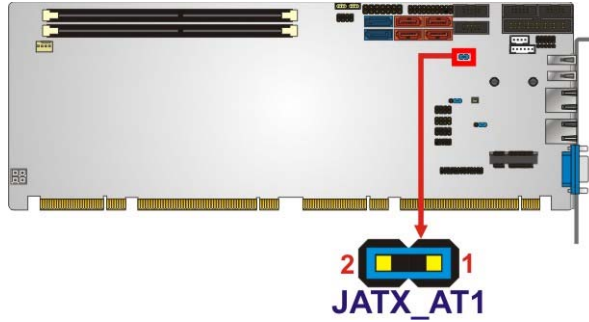

Figure 4-7: AT/ATX Power Mode Jumper Location

4.3.2 Clear CMOS Jumper

- Jumper Label:** J_CMOS1
- Jumper Type:** 3-pin header
- Jumper Settings:** See Table 4-3
- Jumper Location:** See Figure 4-8

To reset the BIOS, move the jumper to the "Clear BIOS" position for 3 seconds or more, and then move back to the default position.

Setting	Description
Short 1-2	Normal
Short 2-3	Clear BIOS

Table 4-3: Clear BIOS Jumper Settings

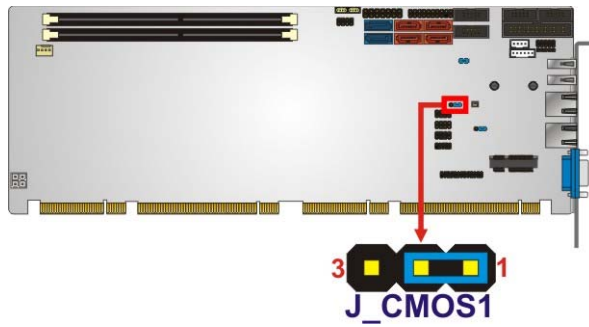

Figure 4-8: Clear BIOS Jumper Location

4.3.3 Wake-on LAN Jumper

- CN Label:** WOL_SEL1
- CN Type:** 3-pin header
- CN Location:** See **Figure 4-9**
- CN Pinouts:** See **Table 4-4**

The Wake-on LAN connector allows the user to enable or disable the Wake-on LAN (WOL) function.

PIN NO.	DESCRIPTION
Short 1-2	Enable Wake-on LAN (Default)
Short 2-3	Disable Wake-on LAN

Table 4-4: Wake-on LAN Connector Pinouts

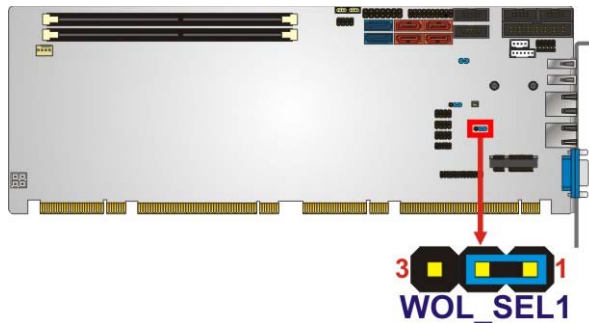

Figure 4-9: Wake-on LAN Connector Pinout Locations

SPCIE-C2060 PICMG 1.3 CPU Card

4.4 Chassis Installation

4.4.1 Airflow



WARNING:

Airflow is critical to the cooling of the CPU and other onboard components. The chassis in which the SPCIE-C2060 Series must have air vents to allow cool air to move into the system and hot air to move out.

The SPCIE-C2060 Series must be installed in a chassis with ventilation holes on the sides allowing airflow to travel through the heat sink surface. In a system with an individual power supply unit, the cooling fan of a power supply can also help generate airflow through the board surface.

4.4.2 CPU Card Installation

To install the CPU card onto the backplane, carefully align the CPU card edge connector with the CPU card socket on the backplane. To do this, please refer to the reference material that came with the backplane. Next, secure the CPU card to the chassis. To do this, please refer to the reference material that came with the chassis.

4.5 Internal Peripheral Device Connections

This section outlines the installation of peripheral devices to the onboard connectors.

4.5.1 Dual RS-232 Cable with Slot Bracket

The dual RS-232 cable slot connector consists of two connectors attached to two independent cables. Each cable is then attached to a D-sub 9 male connector that is mounted onto a slot. To install the dual RS-232 cable, please follow the steps below.

Step 1: Locate the connectors. The locations of the RS-232 connectors are shown in Chapter 3.

Step 2: **Insert the cable connectors.** Insert one connector into each serial port box headers (**Figure 4-10**). A key on the front of the cable connectors ensures the connector can only be installed in one direction.

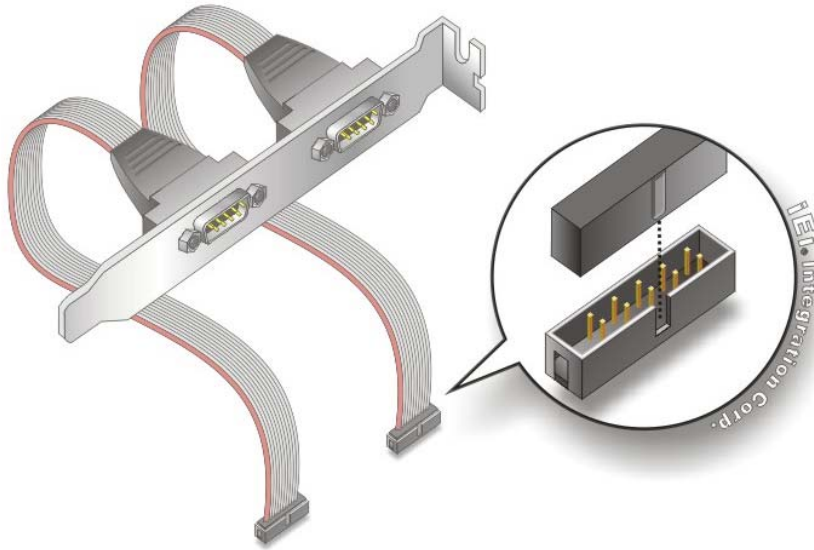

Figure 4-10: Dual RS-232 Cable Installation

Step 3: **Secure the bracket.** The dual RS-232 connector has two D-sub 9 male connectors secured on a bracket. To secure the bracket to the chassis please refer to the reference material that came with the chassis.

4.5.2 DVI-D/USB Kit Installation (DVI Model Only)

The DVI-D/USB kit, consisting of one DVI-D and four USB ports, connects to the DVI-D and USB connectors on the SPCIE-C2060 Series. To install the DVI-D/USB kit, please follow the steps below.

Step 1: **Connect the cables to the DVI-D/USB kit.** Connect the included cables to the DVI-D/USB kit.

Step 2: **Connect the cables to the board.** Connect the other ends of the included cables to the board.

SPCIE-C2060 PICMG 1.3 CPU Card

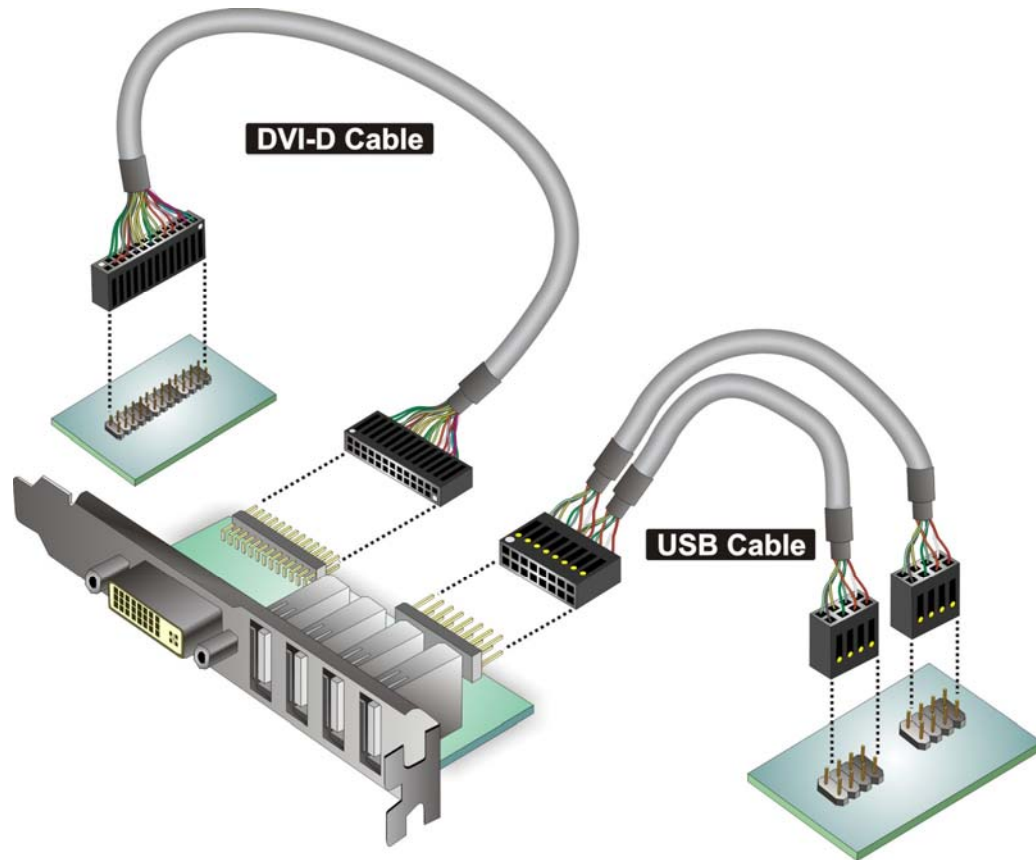

Figure 4-11: DVI-D/USB Kit Installation

Step 3: Mount the DVI-D/USB kit onto the chassis. Once the DVI-D/USB kit is connected to the board, secure the DVI-D/USB kit bracket to the system chassis.

4.5.3 SATA Drive Connection

The SPCIE-C2060 Series is shipped with four SATA drive cables. To connect the SATA drives to the connectors, please follow the steps below.

Step 1: Locate the connectors. The locations of the SATA drive connectors are shown in **Chapter 3**.

Step 2: Insert the cable connector. Press the clip on the connector at the end of the SATA cable and insert the cable connector into the on-board SATA drive connector. See **Figure 4-12**.

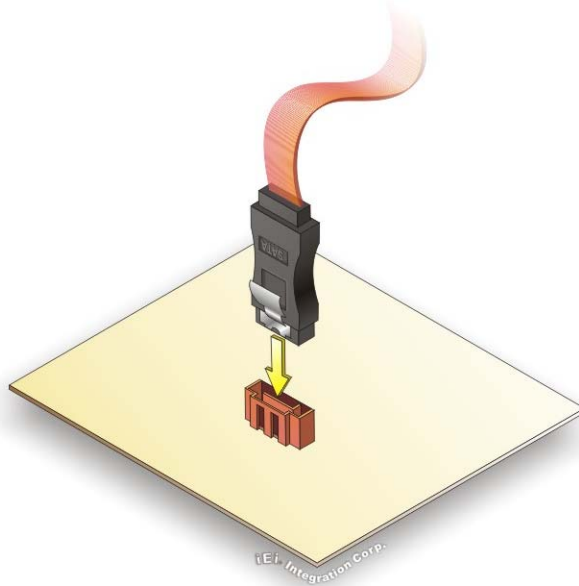

Figure 4-12: SATA Drive Cable Connection

Step 3: **Connect the cable to the SATA disk.** Connect the connector on the other end of the cable to the connector at the back of the SATA drive. See **Figure 4-13**.

Step 4: **Connect the SATA power cable (optional).** Connect the SATA power connector to the back of the SATA drive. See **Figure 4-13**.

SPCIE-C2060 PICMG 1.3 CPU Card

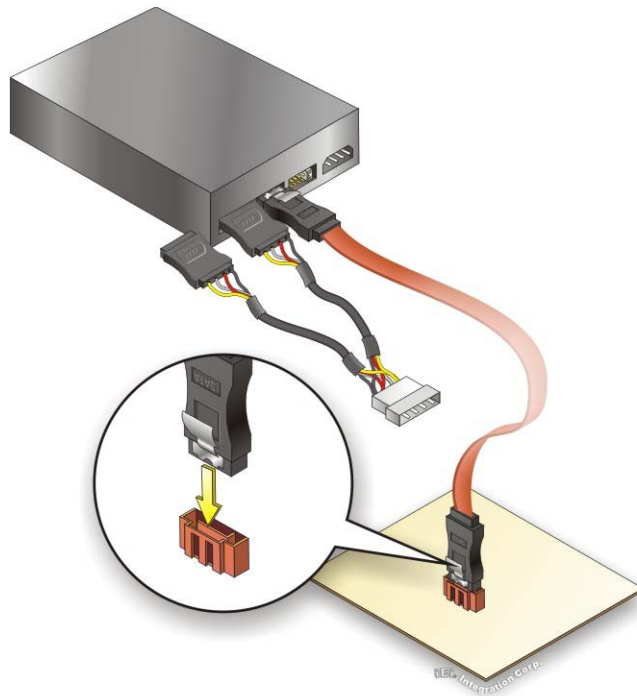

Figure 4-13: SATA Power Drive Connection

4.5.4 USB Cable (Dual Port) with Slot Bracket

The SPCIE-C2060 Series is shipped with a dual port USB 2.0 cable. To connect the USB cable connector, please follow the steps below.

Step 1: **Locate the connectors.** The locations of the USB connectors are shown in Chapter 3.



WARNING:

If the USB pins are not properly aligned, the USB device can burn out.

Step 2: **Align the connectors.** The cable has two connectors. Correctly align pin 1 on each cable connector with pin 1 on the SPCIE-C2060 Series USB connector.

Step 3: **Insert the cable connectors.** Once the cable connectors are properly aligned with the USB connectors on the SPCIE-C2060 Series, connect the cable connectors to the on-board connectors. See **Figure 4-14**.

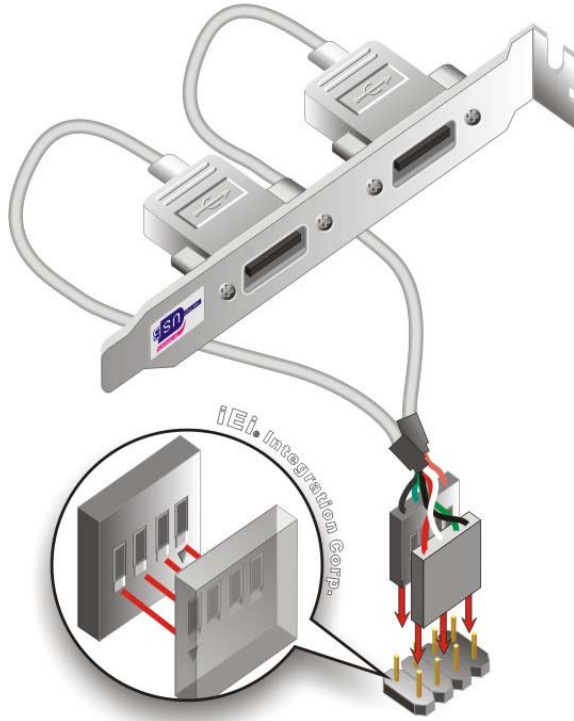

Figure 4-14: Dual USB Cable Connection

Step 4: **Attach the bracket to the chassis.** The USB 2.0 connectors are attached to a bracket. To secure the bracket to the chassis please refer to the installation instructions that came with the chassis.

4.5.5 PCIe Mini Card Installation

To install the PCIe Mini card, please refer to the diagram and instructions below.

SPCIE-C2060 PICMG 1.3 CPU Card

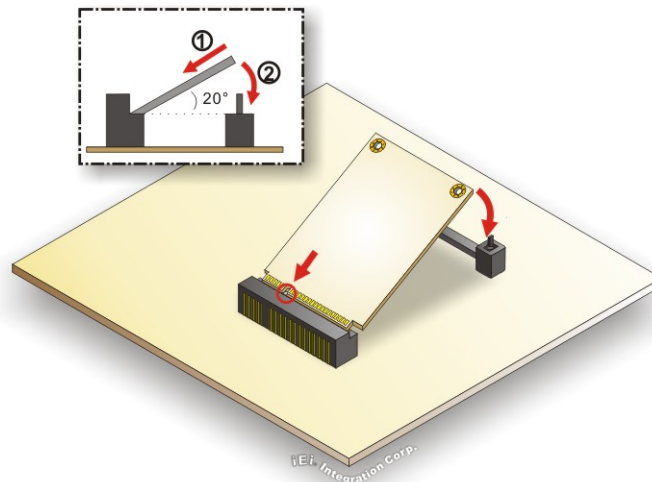

Figure 4-15: PCIe Mini Card Installation

- Step 1:** **Insert into the socket at an angle.** Line up the notch on the card with the notch on the connector. Slide the PCIe Mini card into the socket at an angle of about 20°.
- Step 2:** **Push down until the card clips into place.** Push the other end of the card down until it clips into place on the plastic connector.

4.6 External Peripheral Interface Connection

This section describes connecting devices to the external connectors on the SPCIE-C2060 Series.

4.6.1 LAN Connection

There are two external RJ-45 LAN connectors. The RJ-45 connectors enable connection to an external network. To connect a LAN cable with an RJ-45 connector, please follow the instructions below.

- Step 1:** **Locate the RJ-45 connectors.** The locations of the USB connectors are shown in **Chapter 3**.
- Step 2:** **Align the connectors.** Align the RJ-45 connector on the LAN cable with one of the RJ-45 connectors on the SPCIE-C2060 Series. See **Figure 4-16**.

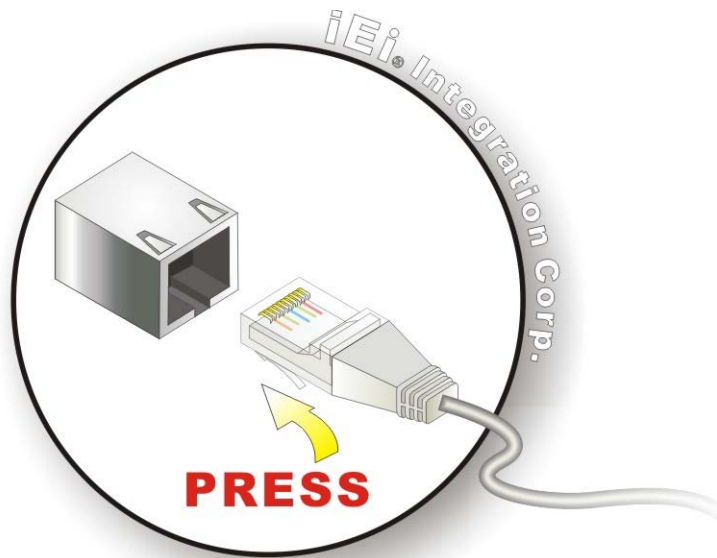

Figure 4-16: LAN Connection

Step 3: Insert the LAN cable RJ-45 connector. Once aligned, gently insert the LAN cable RJ-45 connector into the on-board RJ-45 connector.

4.6.2 USB Device Connection (Single Connector)

There are two external USB 2.0 connectors. Both connectors are perpendicular to the SPCIE-C2060 Series. To connect a USB 2.0 or USB 1.1 device, please follow the instructions below.

Step 1: Located the USB connectors. The locations of the USB connectors are shown in Chapter 3.

Step 2: Align the connectors. Align the USB device connector with one of the connectors on the SPCIE-C2060 Series. See **Figure 4-17**.

SPCIE-C2060 PICMG 1.3 CPU Card

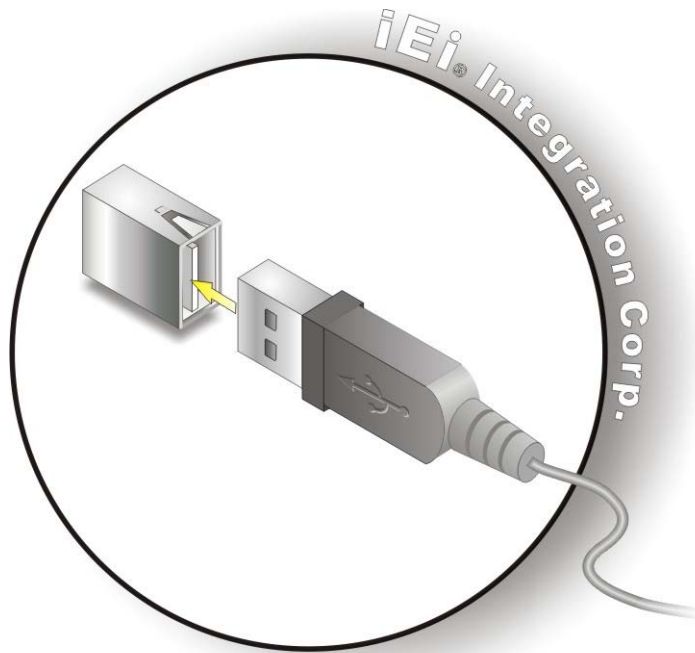

Figure 4-17: USB Device Connection

Step 3: **Insert the device connector.** Once aligned, gently insert the USB device connector into the on-board connector.

4.6.3 VGA Monitor Connection

The SPCIE-C2060 Series has a single female DB-15 connector on the external peripheral interface panel. The DB-15 connector is connected to a CRT or VGA monitor. To connect a monitor to the SPCIE-C2060 Series, please follow the instructions below.

- Step 1:** **Locate the female DB-15 connector.** The location of the female DB-15 connector is shown in **Chapter 3**.
- Step 2:** **Align the VGA connector.** Align the male DB-15 connector on the VGA screen cable with the female DB-15 connector on the external peripheral interface.
- Step 3:** **Insert the VGA connector** Once the connectors are properly aligned with the insert the male connector from the VGA screen into the female connector on the SPCIE-C2060 Series. See **Figure 4-18**.

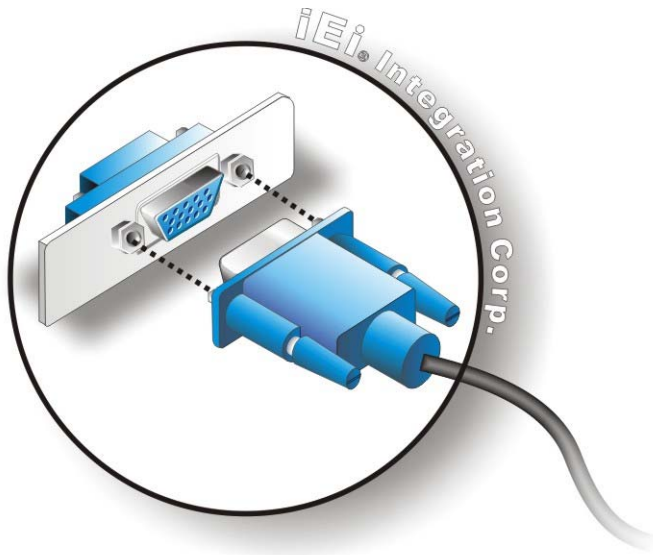

Figure 4-18: VGA Connector

Step 4: **Secure the connector.** Secure the DB-15 VGA connector from the VGA monitor to the external interface by tightening the two retention screws on either side of the connector.

4.7 Intel® AMT Setup Procedure

The SPCIE-C2060 Series is featured with the Intel® Active Management Technology (AMT). To enable the Intel® AMT function, follow the steps below.

- Step 1:** Make sure the DIMM socket is installed with one DDR3 memory.
- Step 2:** Connect an Ethernet cable to the RJ-45 connector labeled **LAN2**.
- Step 3:** The AMI BIOS options regarding the Intel® ME or Intel® AMT must be enabled,
- Step 4:** Properly install the Intel® Management Engine Components drivers from the iAMT Driver & Utility directory in the driver CD. See **Section 6.8**.
- Step 5:** Configure the Intel® Management Engine BIOS extension (MEBx). To get into the Intel® MEBx settings, press <Ctrl+P> after a single beep during boot-up

SPCIE-C2060 PICMG 1.3 CPU Card

process. Enter the Intel® current ME password as it requires (the Intel® default password is **admin**).



NOTE:

To change the password, enter a new password following the strong password rule (containing at least one upper case letter, one lower case letter, one digit and one special character, and be at least eight characters).

Chapter

5

BIOS

SPCIE-C2060 PICMG 1.3 CPU Card

5.1 Introduction

The BIOS is programmed onto the BIOS chip. The BIOS setup program allows changes to certain system settings. This chapter outlines the options that can be changed.



NOTE:

Some of the BIOS options may vary throughout the life cycle of the product and are subject to change without prior notice.

5.1.1 Starting Setup

The UEFI BIOS is activated when the computer is turned on. The setup program can be activated in one of two ways.

1. Press the **DEL** or **F2** key as soon as the system is turned on or
2. Press the **DEL** or **F2** key when the “**Press DEL or F2 to enter SETUP**” message appears on the screen.

If the message disappears before the **DEL** or **F2** key is pressed, restart the computer and try again.

5.1.2 Using Setup

Use the arrow keys to highlight items, press **ENTER** to select, use the PageUp and PageDown keys to change entries, press **F1** for help and press **ESC** to quit. Navigation keys are shown in.

Key	Function
Up arrow	Move to previous item
Down arrow	Move to next item
Left arrow	Move to the item on the left hand side
Right arrow	Move to the item on the right hand side
+	Increase the numeric value or make changes

Key	Function
-	Decrease the numeric value or make changes
Page Up key	Move to the previous page
Page Dn key	Move to the next page
Esc key	Main Menu – Quit and not save changes into CMOS Status Page Setup Menu and Option Page Setup Menu -- Exit current page and return to Main Menu
F1	General help, only for Status Page Setup Menu and Option Page Setup Menu
F2	Load previous values
F3	Load optimized defaults
F4	Save changes and Exit BIOS

Table 5-1: BIOS Navigation Keys

5.1.3 Getting Help

When **F1** is pressed a small help window describing the appropriate keys to use and the possible selections for the highlighted item appears. To exit the Help Window press **Esc** or the **F1** key again.

5.1.4 Unable to Reboot after Configuration Changes

If the computer cannot boot after changes to the system configuration is made, CMOS defaults. Use the jumper described in Chapter 4.

5.1.5 BIOS Menu Bar

The **menu bar** on top of the BIOS screen has the following main items:

- Main – Changes the basic system configuration.
- Advanced – Changes the advanced system settings.
- Chipset – Changes the chipset settings.
- Boot – Changes the system boot configuration.
- Security – Sets User and Supervisor Passwords.

SPCIE-C2060 PICMG 1.3 CPU Card

- Save & Exit – Selects exit options and loads default settings

The following sections completely describe the configuration options found in the menu items at the top of the BIOS screen and listed above.

5.2 Main

The **Main** BIOS menu (**BIOS Menu 1**) appears when the **BIOS Setup** program is entered.

The **Main** menu gives an overview of the basic system information.

Aptio Setup Utility - Copyright (C) 2011 American Megatrends, Inc.					
Main	Advanced	Chipset	Boot	Security	Save & Exit
BIOS Information				Set the Date. Use Tab to switch between Data elements.	
BIOS Vendor			American Megatrends		
Core Version			4.6.5.3		
Compliance			UEFI 2.3; PI 1.2		
Project Version			B201AR31.ROM		
Build Date and Time			11/02/2012 11:53:40		
Processor Information					
Name			SandyBridge		
Brand String			Intel(R) Xeon(R) CPU		
Frequency			3100 MHz		
Processor ID			206a7		
Stepping			D2		
Number of Processors			4Core(s) / 4Thread(s)		
Microcode Revision			28		
GT Info			GT2 (1350 MHz)		

IGFX VBIOS Version			2137		
Memory RC Version			1.2.2.0		
Total Memory			2048 MB (DDR3)		
Memory Frequency			1333 MHz		
PCH Information					
Name			CougarPoint		
Stepping			05/B3		
TXT Capability of Platform/PCH			Supported		
LAN PHY Revision			C0		
ME FW Version			8.0.0.1351	→←: Select Screen	
ME Firmware SKU			5MB	↑ ↓: Select Item	
SPI Clock Frequency				Enter: Select	
DOFR Support			Unsupported	+/-: Change Opt.	
Read Status Clock Frequency			33 MHz	F1: General Help	
Write Status Clock Frequency			33 MHz	F2: Previous Values	
Fast Read Status Clock Frequency			33 MHz	F3: Optimized Defaults	
System Date		[Mon 04/01/2013]		F4: Save & Exit	
System Time		[15:10:27]		ESC: Exit	
Access Level			Administrator		
Version 2.14.1219. Copyright (C) 2011 American Megatrends, Inc.					

BIOS Menu 1: Main

SPCIE-C2060 PICMG 1.3 CPU Card

→ System Overview

The system overview lists a brief summary of the BIOS. The fields in system overview cannot be changed. The items shown in the system overview include:

- BIOS Information
- Processor Information
- Memory Information
- PCH Information
- SPI Clock Frequency

The **Main** menu has two user configurable fields:

→ System Date [xx/xx/xx]

Use the **System Date** option to set the system date. Manually enter the day, month and year.

→ System Time [xx:xx:xx]

Use the **System Time** option to set the system time. Manually enter the hours, minutes and seconds.

5.3 Advanced

Use the **Advanced** menu (**BIOS Menu 2**) to configure the CPU and peripheral devices through the following sub-menus:



WARNING!

Setting the wrong values in the sections below may cause the system to malfunction. Make sure that the settings made are compatible with the hardware.

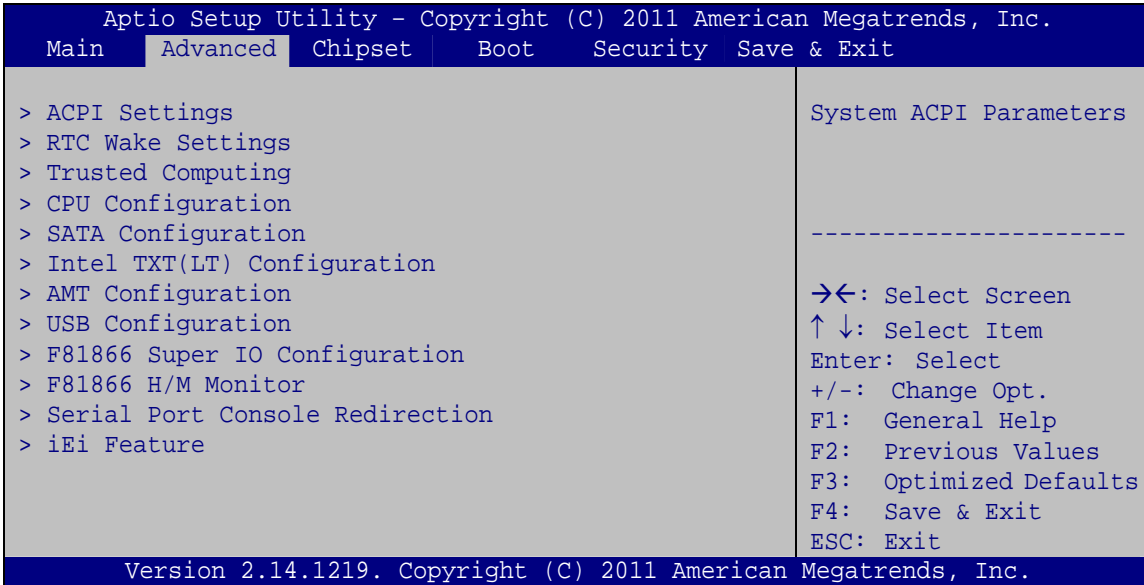

BIOS Menu 2: Advanced

5.3.1 ACPI Settings

The **ACPI Settings** menu (**BIOS Menu 3**) configures the Advanced Configuration and Power Interface (ACPI) options.

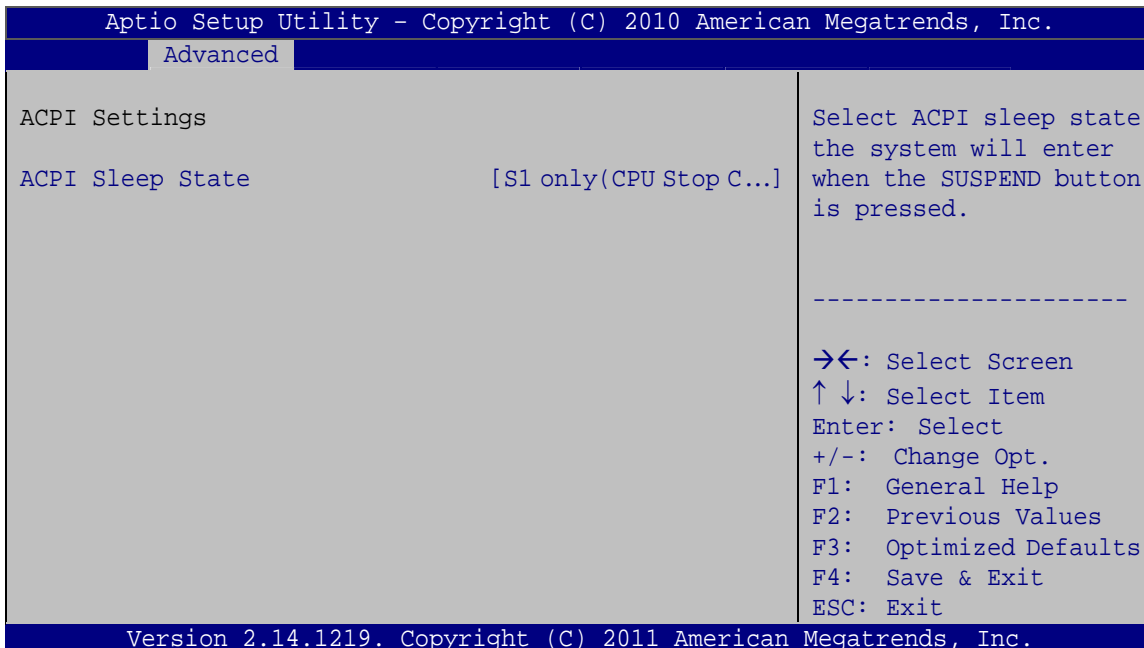

BIOS Menu 3: ACPI Configuration

SPCIE-C2060 PICMG 1.3 CPU Card

→ ACPI Sleep State [S1 only (CPU Stop Clock)]

Use the **ACPI Sleep State** option to specify the sleep state the system enters when it is not being used.

→ Suspend Disabled

→ **S1 only (CPU Stop Clock)** **DEFAULT** The system enters S1(POS) sleep state. The system appears off. The CPU is stopped; RAM is refreshed; the system is running in a low power mode.

→ **S3 only (Suspend to RAM)** The caches are flushed and the CPU is powered off. Power to the RAM is maintained. The computer returns slower to a working state, but more power is saved.

5.3.2 RTC Wake Settings

The **RTC Wake Settings** menu (**BIOS Menu 4**) enables the system to wake at the specified time.

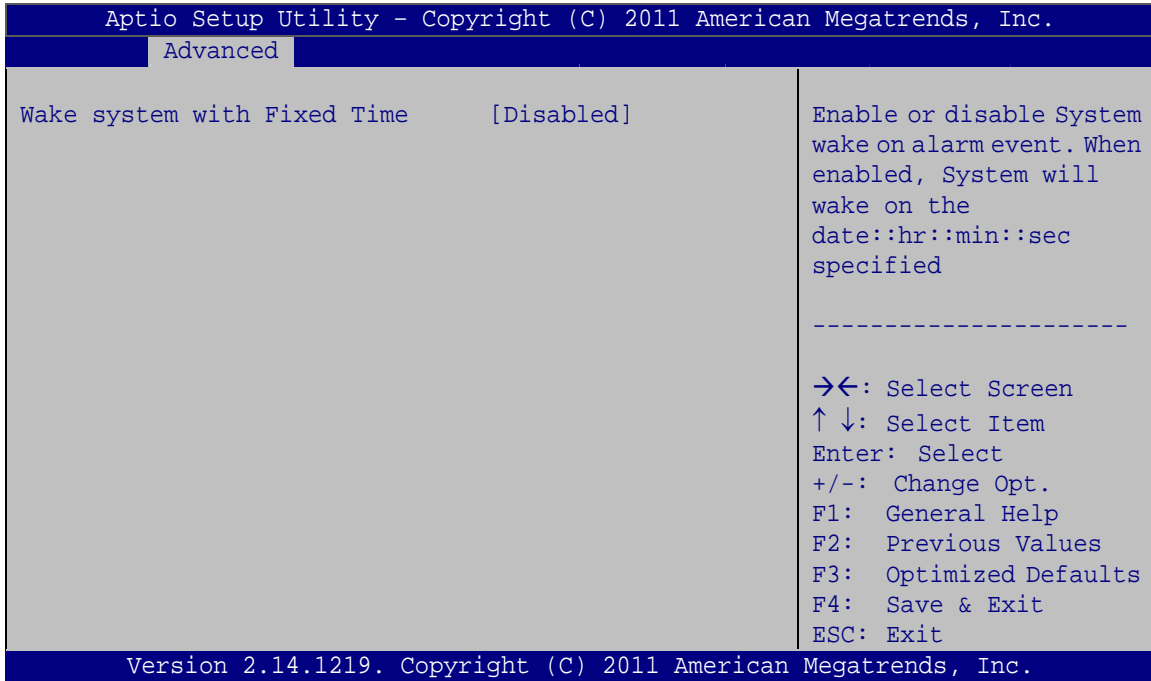

BIOS Menu 4: RTC Wake Settings

→ **Wake system with Fixed Time [Disabled]**

Use the **Wake system with Fixed Time** option to enable or disable the system wake on alarm event.

→ **Disabled** **DEFAULT** The real time clock (RTC) cannot generate a wake event

→ **Enabled** If selected, the **Wake up every day** option appears allowing you to enable to disable the system to wake every day at the specified time. Besides, the following options appear with values that can be selected:

Wake up date

Wake up hour

Wake up minute

Wake up second

After setting the alarm, the computer turns itself on from a suspend state when the alarm goes off.

SPCIE-C2060 PICMG 1.3 CPU Card

5.3.3 Trusted Computing

Use the **Trusted Computing** menu (**BIOS Menu 5**) to configure settings related to the Trusted Computing Group (TCG) Trusted Platform Module (TPM).

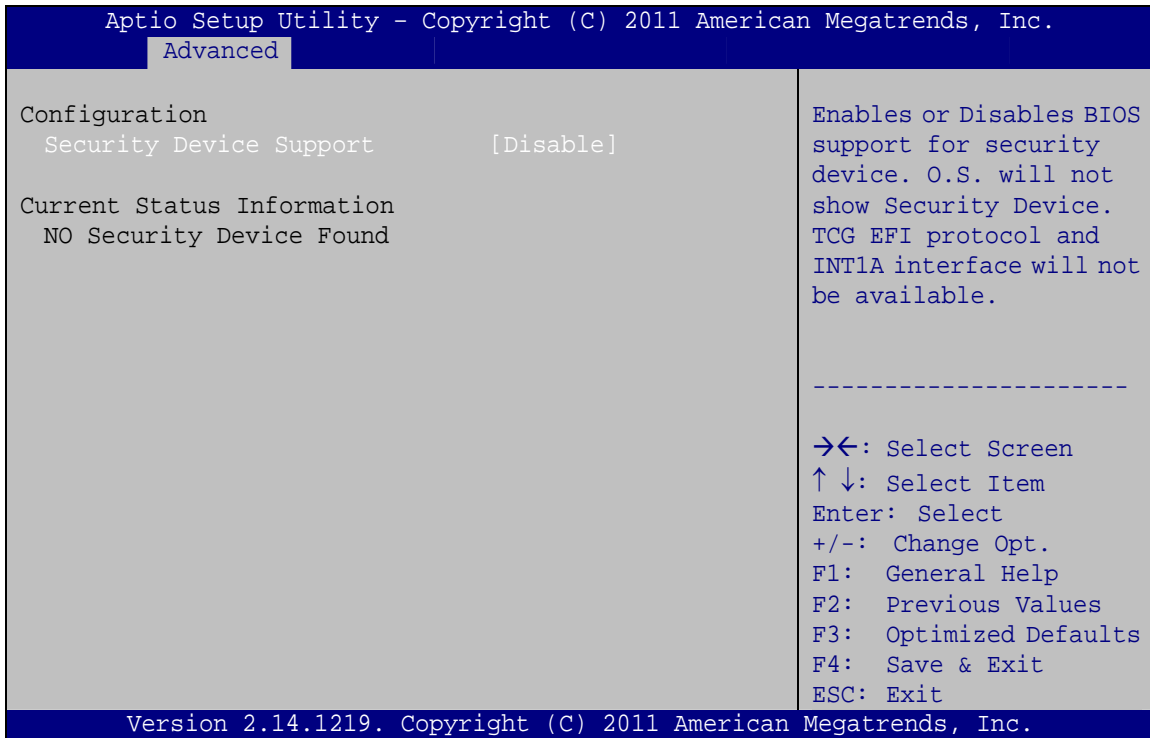

BIOS Menu 5: Trusted Computing

➔ Security Device Support [Disable]

Use the **Security Device Support** option to configure support for the TPM.

- ➔ **Disable** DEFAULT TPM support is disabled.
- ➔ **Enable** TPM support is enabled.

5.3.4 CPU Configuration

Use the **CPU Configuration** menu (**BIOS Menu 6**) to view detailed CPU specifications or enable the Intel Virtualization Technology.

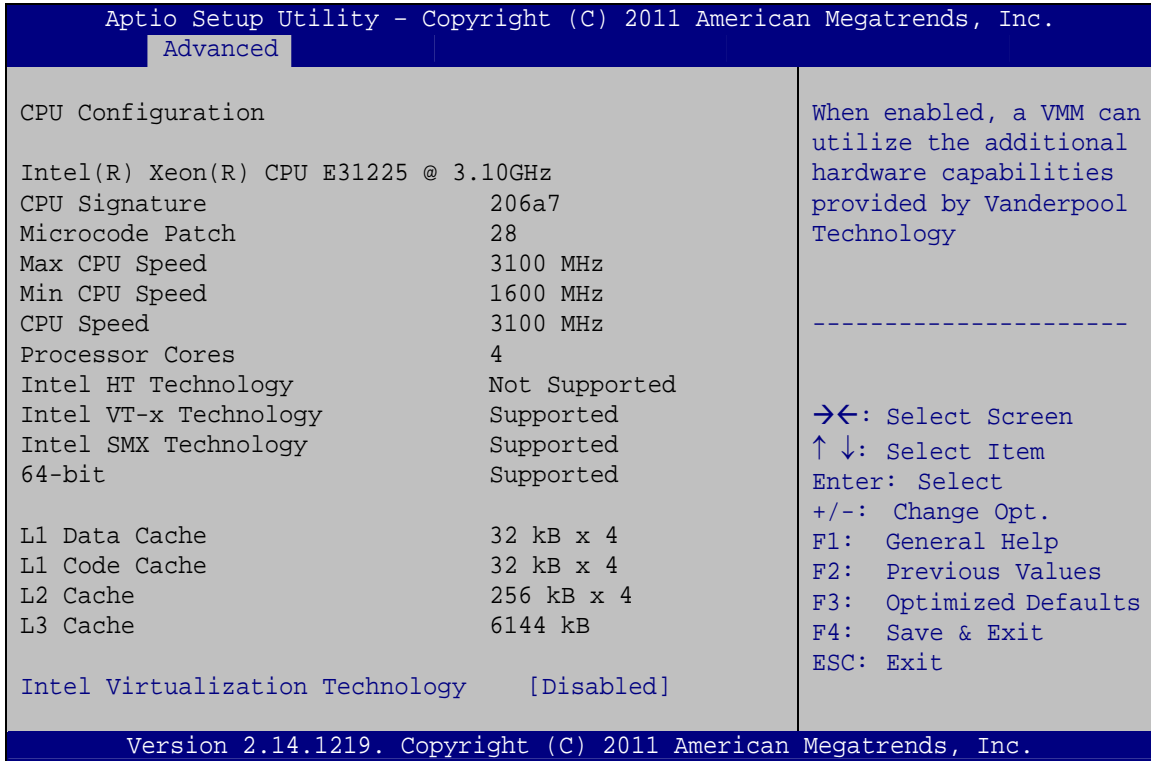

BIOS Menu 6: CPU Configuration

→ **Intel Virtualization Technology [Disabled]**

Use the **Intel Virtualization Technology** option to enable or disable virtualization on the system. When combined with third party software, Intel® Virtualization technology allows several OSs to run on the same system at the same time.

→ **Disabled** **DEFAULT** Disables Intel Virtualization Technology.

→ **Enabled** Enables Intel Virtualization Technology.

SPCIE-C2060 PICMG 1.3 CPU Card

5.3.5 SATA Configuration

Use the **SATA Configuration** menu (**BIOS Menu 7**) to change and/or set the configuration of the SATA devices installed in the system.

```

Aptio Setup Utility - Copyright (C) 2011 American Megatrends, Inc.
  Advanced
SATA Controller(s)          [Enabled]          Enable or disable SATA
SATA Mode Selection        [IDE]              Device.

SATA1 Port                 Empty
SATA2 Port                 Empty
SATA3 Port                 Empty
SATA4 Port                 Empty
SATA5 Port                 Empty
SATA6 Port                 Empty

-----
-><: Select Screen
↑↓: Select Item
Enter: Select
+/-: Change Opt.
F1:  General Help
F2:  Previous Values
F3:  Optimized Defaults
F4:  Save & Exit
ESC: Exit

Version 2.14.1219. Copyright (C) 2011 American Megatrends, Inc.
  
```

BIOS Menu 7: SATA Configuration

→ SATA Controller(s) [Enabled]

Use the **SATA Controller(s)** option to configure the serial ATA controller.

- **Enabled** **DEFAULT** Enables the on-board SATA controller.
- **Disabled** Disables the on-board SATA controller.

→ SATA Mode Selection [IDE]

Use the **SATA Mode Selection** option to configure SATA devices as normal IDE devices.

- **IDE** **DEFAULT** Configures SATA devices as normal IDE device.
- **AHCI** Configures SATA devices as AHCI device.
- **RAID** Configures SATA devices as RAID device.

5.3.6 Intel TXT(LT) Configuration

Use the **Intel TXT(LT) Configuration** menu to configure Intel Trusted Execution Technology support.

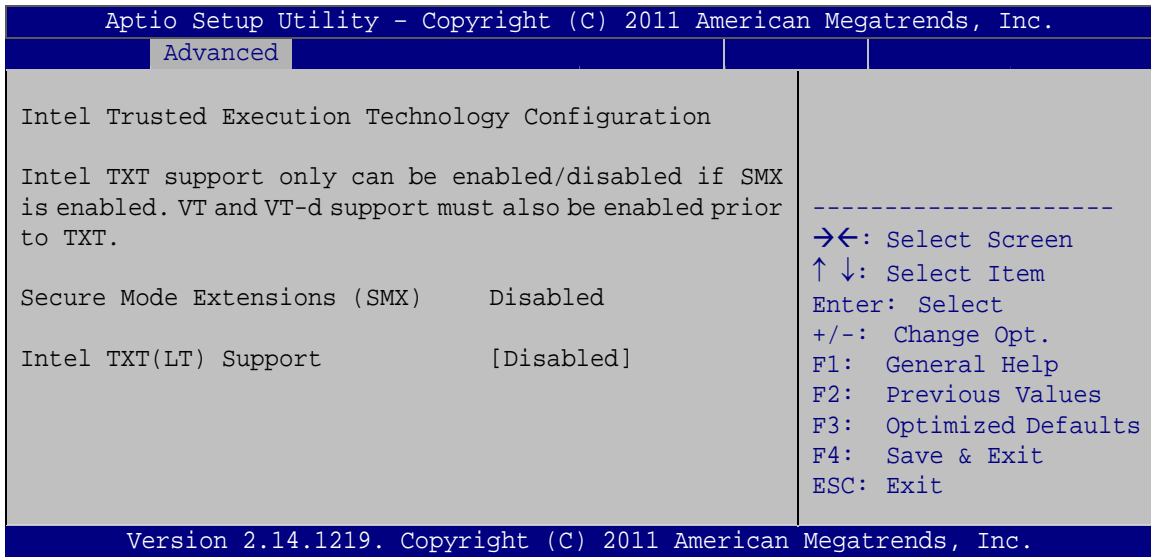

BIOS Menu 8: Intel TXT(LT) Configuration

SPCIE-C2060 PICMG 1.3 CPU Card

5.3.7 AMT Configuration

The **AMT Configuration** menu (**BIOS Menu 9**) allows the advanced power management options to be configured.

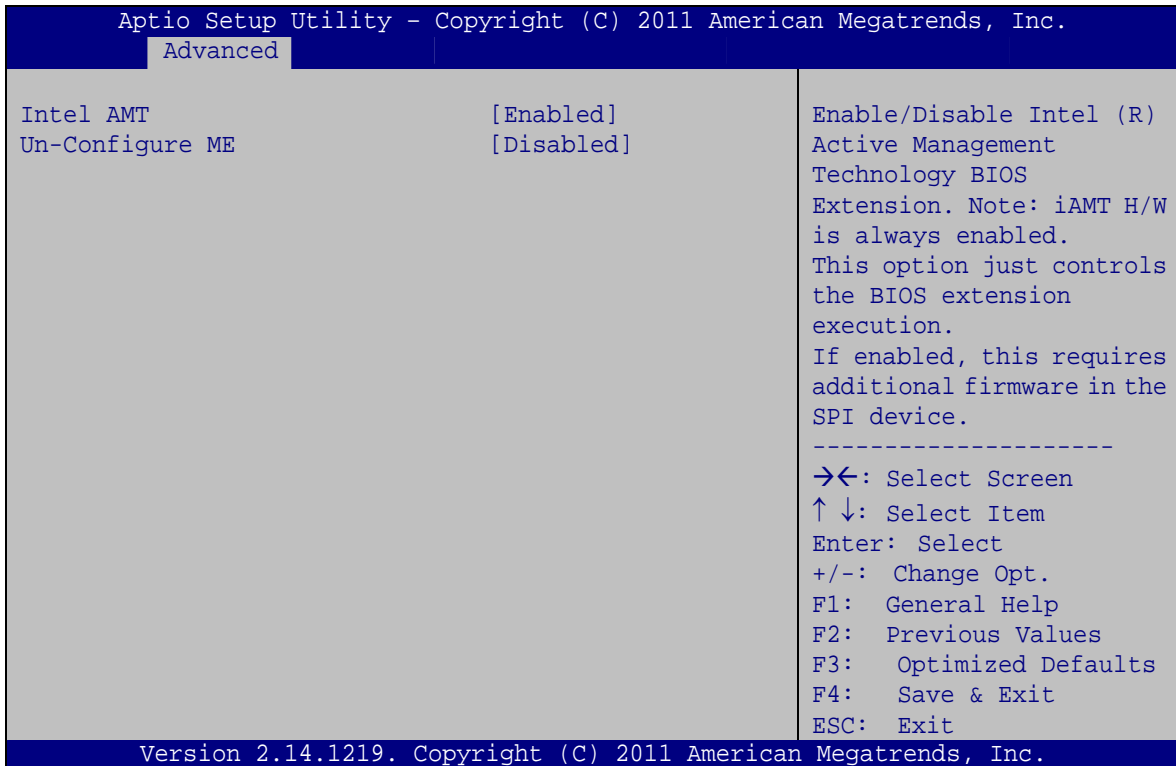

BIOS Menu 9: AMT Configuration

→ Intel AMT [Enabled]

Use **Intel AMT** option to enable or disable the Intel® AMT function.

- **Disabled** Intel® AMT is disabled
- **Enabled** **DEFAULT** Intel® AMT is enabled

→ Un-Configure ME [Disabled]

Use the **Un-Configure ME** option to perform ME unconfigure without password operation.

- **Disabled** **DEFAULT** Not perform ME unconfigure
- **Enabled** To perform ME unconfigure

5.3.8 USB Configuration

Use the **USB Configuration** menu (**BIOS Menu 10**) to read USB configuration information and configure the USB settings.

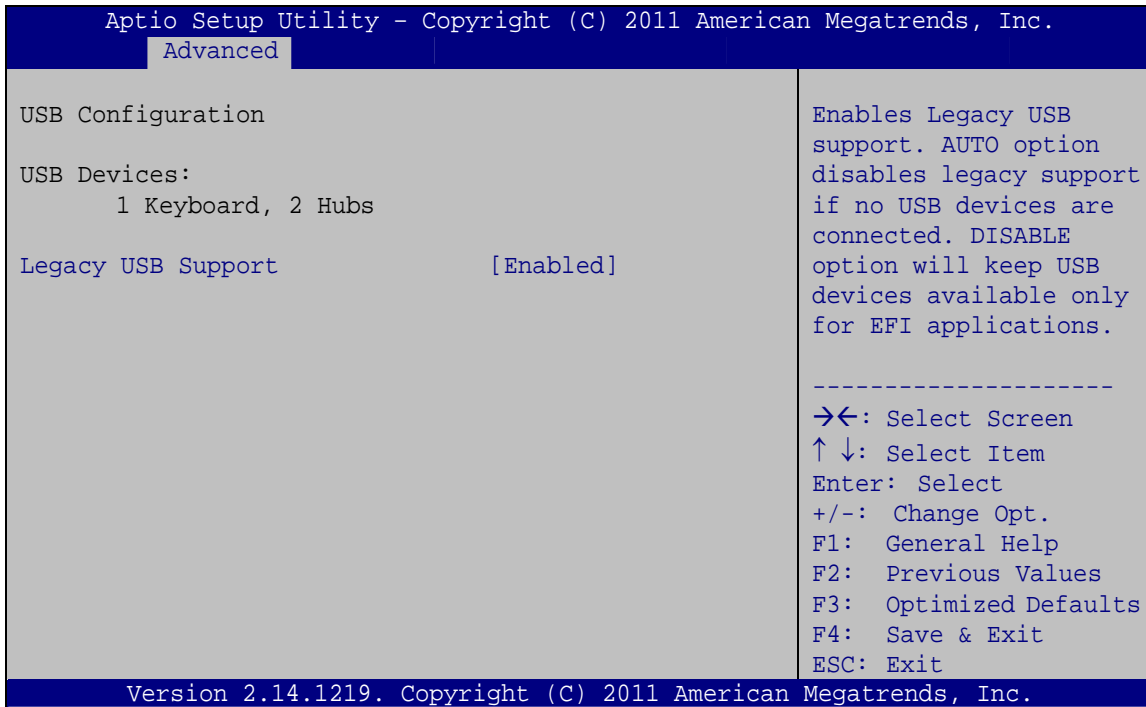

BIOS Menu 10: USB Configuration

→ USB Devices

The **USB Devices** field lists the USB devices that are enabled on the system

→ Legacy USB Support [Enabled]

Use the **Legacy USB Support** BIOS option to enable USB mouse and USB keyboard support. Normally if this option is not enabled, any attached USB mouse or USB keyboard does not become available until a USB compatible operating system is fully booted with all USB drivers loaded. When this option is enabled, any attached USB mouse or USB keyboard can control the system even when there is no USB driver loaded onto the system.

→ **Enabled** **DEFAULT** Legacy USB support enabled

→ **Disabled** Legacy USB support disabled

SPCIE-C2060 PICMG 1.3 CPU Card

5.3.9 F81866 Super IO Configuration

Use the **F81866 Super IO Configuration** menu (**BIOS Menu 11**) to set or change the configurations for the parallel ports and serial ports.

```

Aptio Setup Utility - Copyright (C) 2011 American Megatrends, Inc.
  Advanced
F81866 Super IO Configuration                               Set Parameters of Serial
                                                           Port 1 (COMA)
F81866 Super IO Chip                                     F81866
> Serial Port 1 Configuration
> Serial Port 2 Configuration
> Serial Port 3 Configuration
> Serial Port 4 Configuration
> Serial Port 5 Configuration
> IrDA Configuration
> Parallel Port Configuration
                                                           -----
                                                           →←: Select Screen
                                                           ↑ ↓: Select Item
                                                           Enter: Select
                                                           +/-: Change Opt.
                                                           F1: General Help
                                                           F2: Previous Values
                                                           F3: Optimized Defaults
                                                           F4: Save & Exit
                                                           ESC: Exit
Version 2.14.1219. Copyright (C) 2011 American Megatrends, Inc.
  
```

BIOS Menu 11: Super IO Configuration

5.3.9.1 Serial Port n Configuration

Use the **Serial Port n Configuration** menu (**BIOS Menu 12**) to configure the serial port n.

```

Aptio Setup Utility - Copyright (C) 2011 American Megatrends, Inc.
  Advanced
Serial Port n Configuration                               Enable or Disable Serial
                                                           Port (COM)
Serial Port                                             [Enabled]
Device Settings                                         IO=3F8h; IRQ=4
Change Settings                                         [Auto]
                                                           -----
                                                           →←: Select Screen
                                                           ↑ ↓: Select Item
                                                           Enter: Select
                                                           +/-: Change Opt.
                                                           F1: General Help
                                                           F2: Previous Values
                                                           F3: Optimized Defaults
                                                           F4: Save & Exit
                                                           ESC: Exit
Version 2.14.1219. Copyright (C) 2011 American Megatrends, Inc.
  
```

BIOS Menu 12: Serial Port n Configuration Menu

5.3.9.1.1 Serial Port 1 Configuration

→ Serial Port [Enabled]

Use the **Serial Port** option to enable or disable the serial port.

- **Disabled** Disable the serial port
- **Enabled** **DEFAULT** Enable the serial port

→ Change Settings [Auto]

Use the **Change Settings** option to change the serial port IO port address and interrupt address.

- **Auto** **DEFAULT** The serial port IO port address and interrupt address are automatically detected.
- **IO=3F8h;**
IRQ=4 Serial Port I/O port address is 3F8h and the interrupt address is IRQ4
- **IO=3F8h;**
IRQ=3, 4 Serial Port I/O port address is 3F8h and the interrupt address is IRQ3, 4
- **IO=2F8h;**
IRQ=3, 4 Serial Port I/O port address is 2F8h and the interrupt address is IRQ3, 4
- **IO=2C0h;**
IRQ=3, 4 Serial Port I/O port address is 2C0h and the interrupt address is IRQ3, 4
- **IO=2C8h;**
IRQ=3, 4 Serial Port I/O port address is 2C8h and the interrupt address is IRQ3, 4

5.3.9.1.2 Serial Port 2 Configuration

→ Serial Port [Enabled]

Use the **Serial Port** option to enable or disable the serial port.

- **Disabled** Disable the serial port
- **Enabled** **DEFAULT** Enable the serial port

SPCIE-C2060 PICMG 1.3 CPU Card

→ Change Settings [Auto]

Use the **Change Settings** option to change the serial port IO port address and interrupt address.

- **Auto** **DEFAULT** The serial port IO port address and interrupt address are automatically detected.
- **IO=2F8h;**
IRQ=3 Serial Port I/O port address is 2F8h and the interrupt address is IRQ3
- **IO=3F8h;**
IRQ=3, 4 Serial Port I/O port address is 3F8h and the interrupt address is IRQ3, 4
- **IO=2F8h;**
IRQ=3, 4 Serial Port I/O port address is 2F8h and the interrupt address is IRQ3, 4
- **IO=2C0h;**
IRQ=3, 4 Serial Port I/O port address is 2C0h and the interrupt address is IRQ3, 4
- **IO=2C8h;**
IRQ=3, 4 Serial Port I/O port address is 2C8h and the interrupt address is IRQ3, 4

5.3.9.1.3 Serial Port 3 Configuration

→ Serial Port [Enabled]

Use the **Serial Port** option to enable or disable the serial port.

- **Disabled** Disable the serial port
- **Enabled** **DEFAULT** Enable the serial port

→ Change Settings [Auto]

Use the **Change Settings** option to change the serial port IO port address and interrupt address.

- **Auto** **DEFAULT** The serial port IO port address and interrupt address are automatically detected.

- **IO=3E8h;**
IRQ=10 Serial Port I/O port address is 3E8h and the interrupt address is IRQ10
- **IO=3E8h;**
IRQ=10, 11 Serial Port I/O port address is 3E8h and the interrupt address is IRQ10, 11
- **IO=2E8h;**
IRQ=10, 11 Serial Port I/O port address is 2E8h and the interrupt address is IRQ10, 11
- **IO=2D0h;**
IRQ=10, 11 Serial Port I/O port address is 2D0h and the interrupt address is IRQ10, 11
- **IO=2D8h;**
IRQ=10, 11 Serial Port I/O port address is 2D8h and the interrupt address is IRQ10, 11

5.3.9.1.4 Serial Port 4 Configuration

→ **Serial Port [Enabled]**

Use the **Serial Port** option to enable or disable the serial port.

- **Disabled** Disable the serial port
- **Enabled DEFAULT** Enable the serial port

→ **Change Settings [Auto]**

Use the **Change Settings** option to change the serial port IO port address and interrupt address.

- **Auto DEFAULT** The serial port IO port address and interrupt address are automatically detected.
- **IO=2E8h;**
IRQ=10 Serial Port I/O port address is 2E8h and the interrupt address is IRQ10
- **IO=3E8h;**
IRQ=10, 11 Serial Port I/O port address is 3E8h and the interrupt address is IRQ10, 11
- **IO=2E8h;**
IRQ=10, 11 Serial Port I/O port address is 2E8h and the interrupt address is IRQ10, 11

SPCIE-C2060 PICMG 1.3 CPU Card

- ➔ **IO=2D0h;**
IRQ=10, 11 Serial Port I/O port address is 2D0h and the interrupt address is IRQ10, 11
- ➔ **IO=2D8h;**
IRQ=10, 11 Serial Port I/O port address is 2D8h and the interrupt address is IRQ10, 11

5.3.9.1.5 Serial Port 5 Configuration

➔ Serial Port [Enabled]

Use the **Serial Port** option to enable or disable the serial port.

- ➔ **Disabled** Disable the serial port
- ➔ **Enabled** **DEFAULT** Enable the serial port

➔ Change Settings [Auto]

Use the **Change Settings** option to change the serial port IO port address and interrupt address.

- ➔ **Auto** **DEFAULT** The serial port IO port address and interrupt address are automatically detected.
- ➔ **IO=2D0h;**
IRQ=10 Serial Port I/O port address is 2D0h and the interrupt address is IRQ10
- ➔ **IO=2C0h;**
IRQ=10, 11 Serial Port I/O port address is 2C0h and the interrupt address is IRQ10, 11
- ➔ **IO=2C8h;**
IRQ=10, 11 Serial Port I/O port address is 2C8h and the interrupt address is IRQ10, 11
- ➔ **IO=2D0h;**
IRQ=10, 11 Serial Port I/O port address is 2D0h and the interrupt address is IRQ10, 11
- ➔ **IO=2D8h;**
IRQ=10, 11 Serial Port I/O port address is 2D8h and the interrupt address is IRQ10, 11
- ➔ **IO=2E0h;**
IRQ=10, 11 Serial Port I/O port address is 2E0h and the interrupt address is IRQ10, 11

5.3.9.2 IrDA Configuration

Use the **IrDA Configuration** menu (**BIOS Menu 13**) to set the parameters of the floppy disk controller.

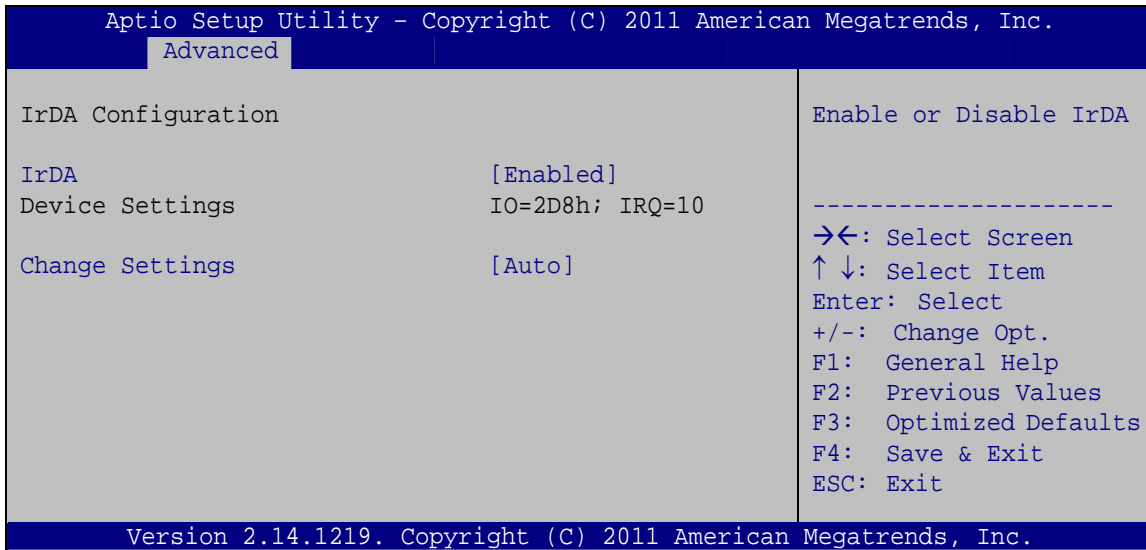

BIOS Menu 13: IrDA Configuration Menu

→ IrDA [Enabled]

Use the **IrDA** option to enable or disable the IrDA function.

- **Disabled** Disable the IrDA function
- **Enabled DEFAULT** Enable the IrDA function

→ Change Settings [Auto]

Use the **Change Settings** option to change the serial port IO port address and interrupt address.

- **Auto DEFAULT** The serial port IO port address and interrupt address are automatically detected.
- **IO=2D8h; Serial Port I/O port address is 2D8h and the interrupt
IRQ=10 address is IRQ10**

SPCIE-C2060 PICMG 1.3 CPU Card

- ➔ **IO=2C0h;** Serial Port I/O port address is 2C0h and the interrupt address is IRQ10, 11
IRQ=10, 11
- ➔ **IO=2C8h;** Serial Port I/O port address is 2C8h and the interrupt address is IRQ10, 11
IRQ=10, 11
- ➔ **IO=2D0h;** Serial Port I/O port address is 2D0h and the interrupt address is IRQ10, 11
IRQ=10, 11
- ➔ **IO=2D8h;** Serial Port I/O port address is 2D8h and the interrupt address is IRQ10, 11
IRQ=10, 11
- ➔ **IO=2E0h;** Serial Port I/O port address is 2E0h and the interrupt address is IRQ10, 11
IRQ=10, 11

5.3.9.3 Parallel Port Configuration

Use the **Parallel Port Configuration** menu (**BIOS Menu 12**) to configure the serial port n.

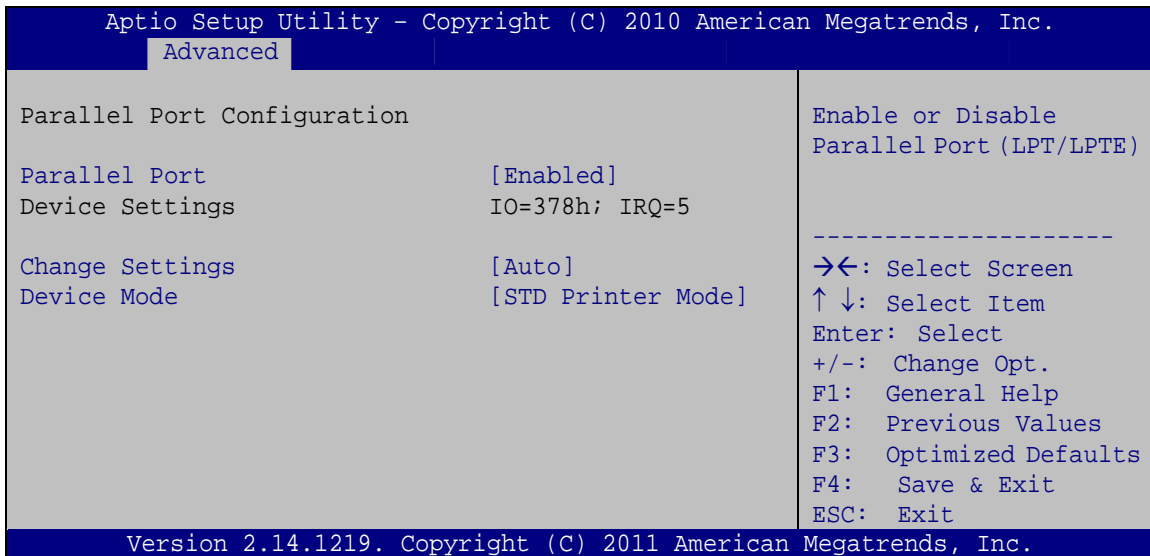

BIOS Menu 14: Parallel Port Configuration Menu

- ➔ **Parallel Port [Enabled]**

Use the **Parallel Port** option to enable or disable the parallel port.

- ➔ **Disabled** Disable the parallel port
- ➔ **Enabled DEFAULT** Enable the parallel port

→ Change Settings [Auto]

Use the **Change Settings** option to change the parallel port IO port address and interrupt address.

- | | | | |
|---|------------------------------|----------------|---|
| → | Auto | DEFAULT | The parallel port IO port address and interrupt address are automatically detected. |
| → | IO=378h;
IRQ=5 | | Parallel Port I/O port address is 378h and the interrupt address is IRQ5 |
| → | IO=378h;
IRQ=5, 7 | | Parallel Port I/O port address is 378h and the interrupt address is IRQ5, 7 |
| → | IO=278h;
IRQ=5, 7 | | Parallel Port I/O port address is 278h and the interrupt address is IRQ5, 7 |
| → | IO=3BCh;
IRQ=5, 7 | | Parallel Port I/O port address is 3BCh and the interrupt address is IRQ5, 7 |

→ Device Mode [STD Printer Mode]

Use the **Device Mode** option to select the mode the parallel port operates in. Configuration options are listed below.

- | | | |
|---|----------------------|----------------|
| ▪ | STD Printer Mode | Default |
| ▪ | SPP Mode | |
| ▪ | EPP-1.9 and SPP Mode | |
| ▪ | EPP-1.7 and SPP Mode | |
| ▪ | ECP Mode | |
| ▪ | ECP and EPP 1.9 Mode | |
| ▪ | ECP and EPP 1.7 Mode | |

5.3.10 F81866 H/W Monitor

The **F81866 H/W Monitor** menu (**BIOS Menu 15**) contains the fan configuration submenu, and displays the system temperature and CPU fan speed.

SPCIE-C2060 PICMG 1.3 CPU Card

```

Aptio Setup Utility - Copyright (C) 2011 American Megatrends, Inc.
Advanced
PC Health Status
> Smart Fan Mode Configuration
CPU Temperature           :+27 C
System Temperature       :+36 C
CPU_FAN1 Speed           :2362 RPM

Smart Fan Mode Select
-----
-><: Select Screen
↑↓: Select Item
Enter: Select
+/-: Change Opt.
F1: General Help
F2: Previous Values
F3: Optimized Defaults
F4: Save & Exit
ESC: Exit

Version 2.14.1219. Copyright (C) 2011 American Megatrends, Inc.

```

BIOS Menu 15: F81866 H/W Monitor**→ PC Health Status**

The following system parameters and values are shown. The system parameters that are monitored are:

- CPU Temperature
- System Temperature
- CPU Fan Speed

5.3.10.1 Smart Fan Mode Configuration

Use the **Smart Fan Mode Configuration** submenu (BIOS Menu 16) to configure fan 1 temperature and speed settings.

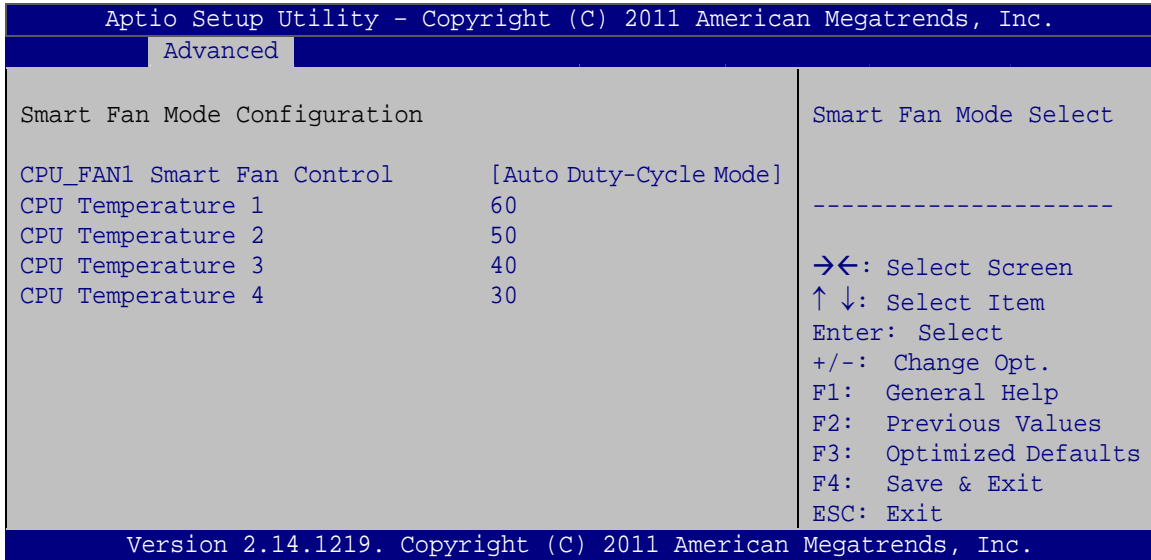

BIOS Menu 16: Smart Fan Mode Configuration

→ **CPU_FAN1 Smart Fan Control [Auto Duty-Cycle Mode]**

Use the **CPU_FAN1 Smart Fan Control** option to configure the CPU Smart Fan.

- **Auto** **DEFAULT** The fan adjusts its speed using Auto Duty-Cycle Mode settings
- **Manual Duty** The fan spins at the speed set in Manual Duty Mode settings

→ **CPU Temperature n**

Use the +/- key or enter a decimal number to change the **CPU Temperature n** value.

5.3.11 Serial Port Console Redirection

The **Serial Port Console Redirection** menu (**BIOS Menu 17**) allows the console redirection options to be configured. Console redirection allows users to maintain a system remotely by re-directing keyboard input and text output through the serial port.

SPCIE-C2060 PICMG 1.3 CPU Card

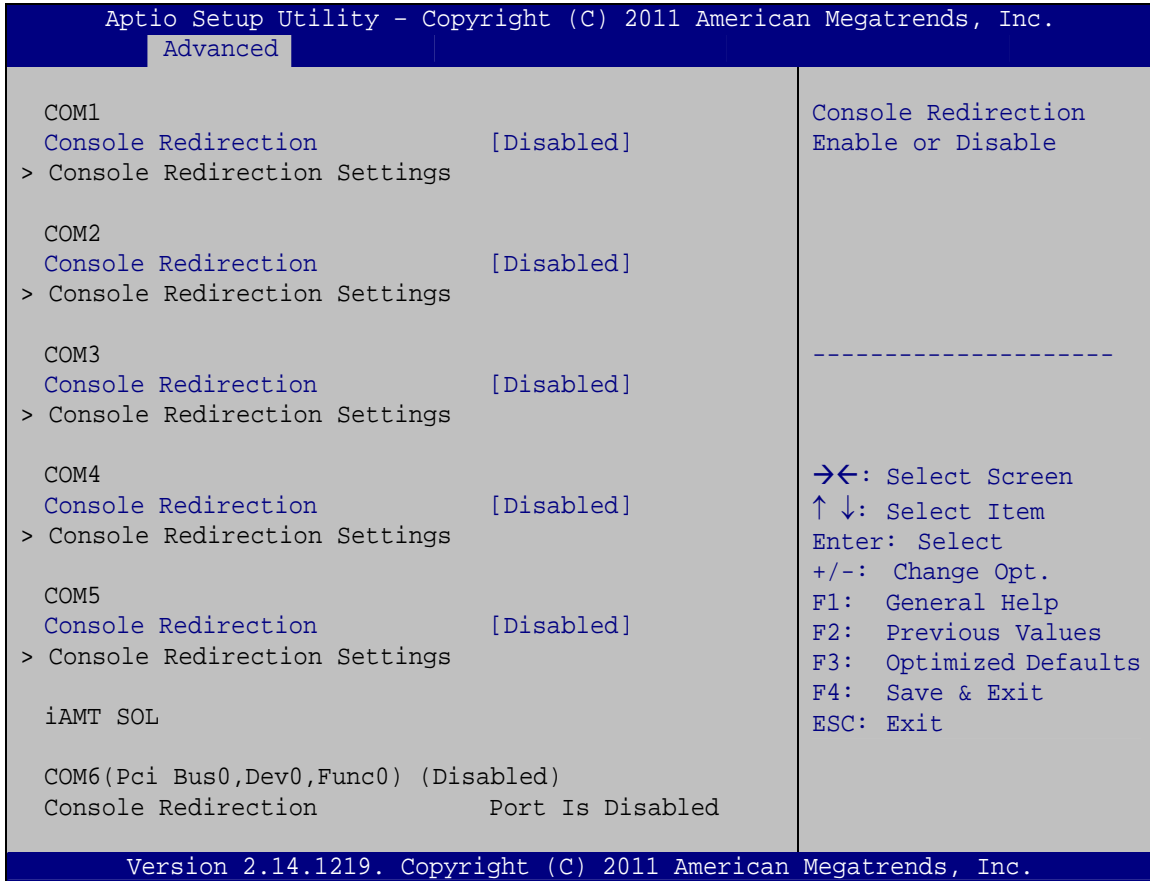

BIOS Menu 17: Serial Port Console Redirection

→ Console Redirection [Disabled]

Use **Console Redirection** option to enable or disable the console redirection function.

- **Disabled** **DEFAULT** Disabled the console redirection function
- **Enabled** Enabled the console redirection function

→ Terminal Type [ANSI]

Use the **Terminal Type** option to specify the remote terminal type.

- **VT100** The target terminal type is VT100
- **VT100+** The target terminal type is VT100+
- **VT-UTF8** The target terminal type is VT-UTF8
- **ANSI** **DEFAULT** The target terminal type is ANSI

→ Bits per second [115200]

Use the **Bits per second** option to specify the serial port transmission speed. The speed must match the other side. Long or noisy lines may require lower speeds.

- | | | |
|-----------------|----------------|--|
| → 9600 | | Sets the serial port transmission speed at 9600. |
| → 19200 | | Sets the serial port transmission speed at 19200. |
| → 38400 | | Sets the serial port transmission speed at 38400. |
| → 57600 | | Sets the serial port transmission speed at 57600. |
| → 115200 | DEFAULT | Sets the serial port transmission speed at 115200. |

→ Data Bits [8]

Use the **Data Bits** option to specify the number of data bits.

- | | | |
|------------|----------------|--------------------------|
| → 7 | | Sets the data bits at 7. |
| → 8 | DEFAULT | Sets the data bits at 8. |

→ Parity [None]

Use the **Parity** option to specify the parity bit that can be sent with the data bits for detecting the transmission errors.

- | | | |
|----------------|----------------|---|
| → None | DEFAULT | No parity bit is sent with the data bits. |
| → Even | | The parity bit is 0 if the number of ones in the data bits is even. |
| → Odd | | The parity bit is 0 if the number of ones in the data bits is odd. |
| → Mark | | The parity bit is always 1. This option does not provide error detection. |
| → Space | | The parity bit is always 0. This option does not provide error detection. |

SPCIE-C2060 PICMG 1.3 CPU Card

→ Stop Bits [1]

Use the **Stop Bits** option to specify the number of stop bits used to indicate the end of a serial data packet. Communication with slow devices may require more than 1 stop bit.

- **1** **DEFAULT** Sets the number of stop bits at 1.
- **2** Sets the number of stop bits at 2.

5.3.12 iEi Feature

Use the **iEi Feature** menu (**BIOS Menu 18**) to configure One Key Recovery function.

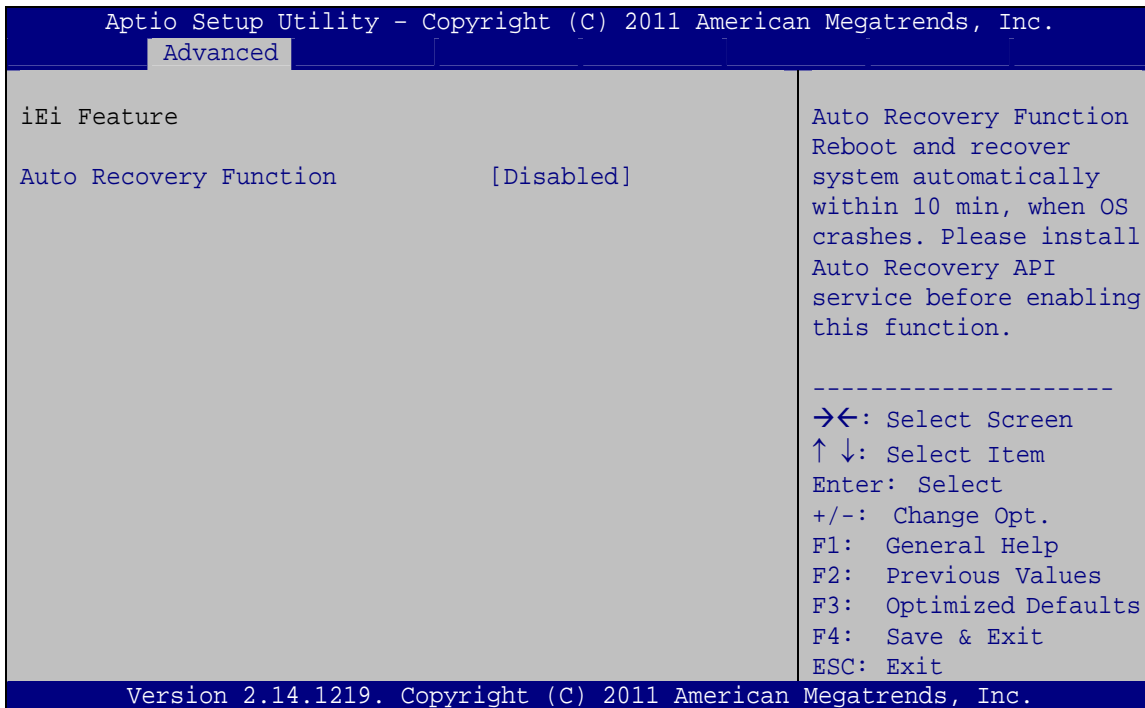

BIOS Menu 18: iEi Feature

→ Auto Recovery Function [Disabled]

Use the **Auto Recovery Function** BIOS option to enable or disable the auto recovery function of the IEI One Key Recovery.

- **Disabled** **DEFAULT** Auto recovery function disabled
- **Enabled** Auto recovery function enabled

5.4 Chipset

Use the **Chipset** menu (**BIOS Menu 19**) to access the PCH IO and System Agent (SA) configuration menus.



WARNING!

Setting the wrong values for the Chipset BIOS selections in the Chipset BIOS menu may cause the system to malfunction.

```
Aptio Setup Utility - Copyright (C) 2011 American Megatrends, Inc.
Main   Advanced  Chipset  Boot   Security  Save & Exit
-----
> System Agent (SA) Configuration      System Agent (SA)
> PCH-IO Configuration                Parameters

-----
-><: Select Screen
↑↓: Select Item
Enter: Select
+/-: Change Opt.
F1:  General Help
F2:  Previous Values
F3:  Optimized Defaults
F4:  Save & Exit
ESC: Exit

Version 2.14.1219. Copyright (C) 2011 American Megatrends, Inc.
```

BIOS Menu 19: Chipset

SPCIE-C2060 PICMG 1.3 CPU Card

5.4.1 System Agent (SA) Configuration

Use the **System Agent (SA) Configuration** menu (**BIOS Menu 20**) to configure the System Agent (SA) parameters.

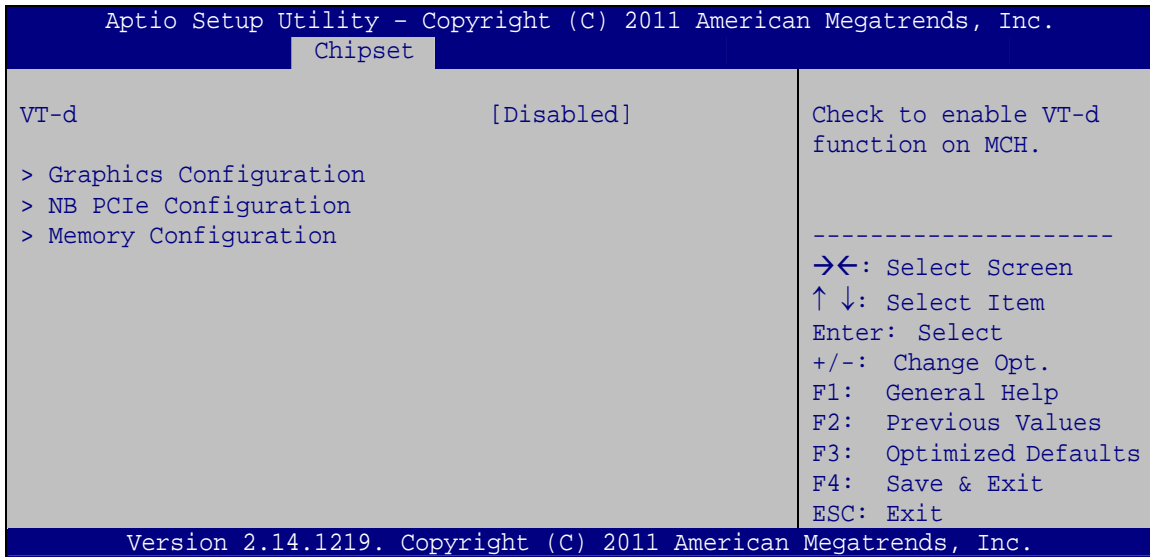

BIOS Menu 20: System Agent (SA) Configuration

→ VT-d [Disabled]

Use the **VT-d** option to enable or disable VT-d support.

- **Disabled** **DEFAULT** Disables VT-d support.
- **Enabled** Enables VT-d support.

5.4.1.1 Graphics Configuration

Use the **Graphics Configuration** (**BIOS Menu 21**) menu to configure the video device connected to the system.

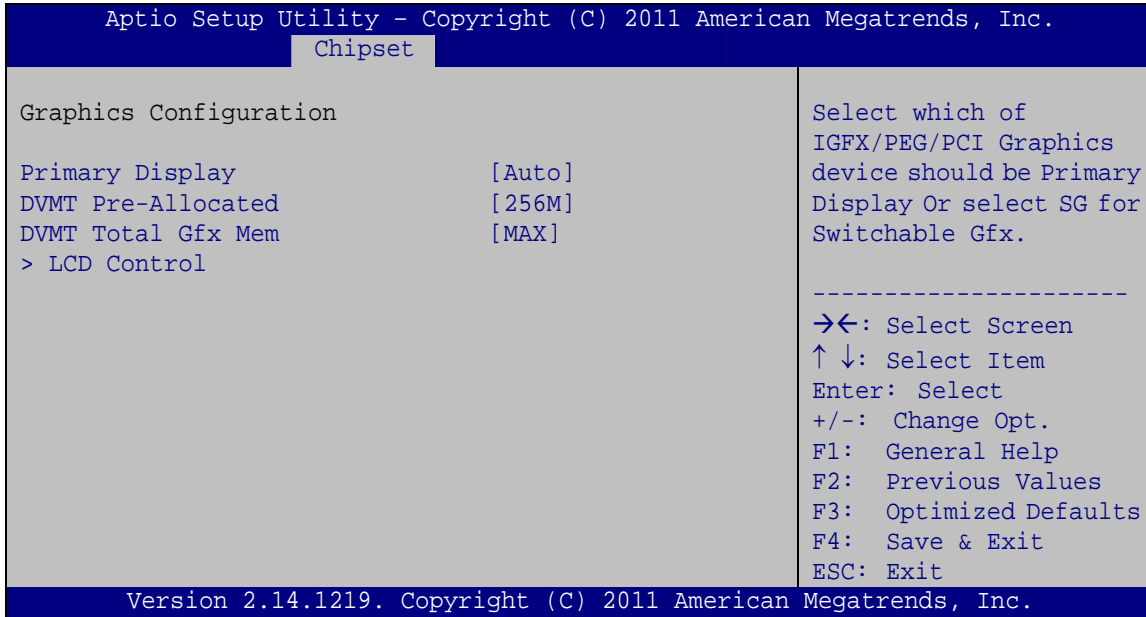

BIOS Menu 21: Graphics Configuration

→ **Primary Display [Auto]**

Use the **Primary Display** option to select the primary graphics controller the system uses.

The following options are available:

- Auto **Default**
- IGFX
- PEG
- PCI

→ **DVMT Pre-Allocated [256M]**

Use the **DVMT Pre-Allocated** option to set the amount of system memory allocated to the integrated graphics processor when the system boots. The system memory allocated can then only be used as graphics memory, and is no longer available to applications or the operating system. Configuration options are listed below:

- 32M
- 64M
- 128M
- 256M **Default**
- 512M

SPCIE-C2060 PICMG 1.3 CPU Card

→ DVMT Total Gfx Mem [MAX]

Use the **DVMT Total Gfx Mem** option to select DVMT5.0 total graphic memory size used by the internal graphic device. The following options are available:

- 128M
- 256M
- MAX **Default**

5.4.1.1.1 LCD Control

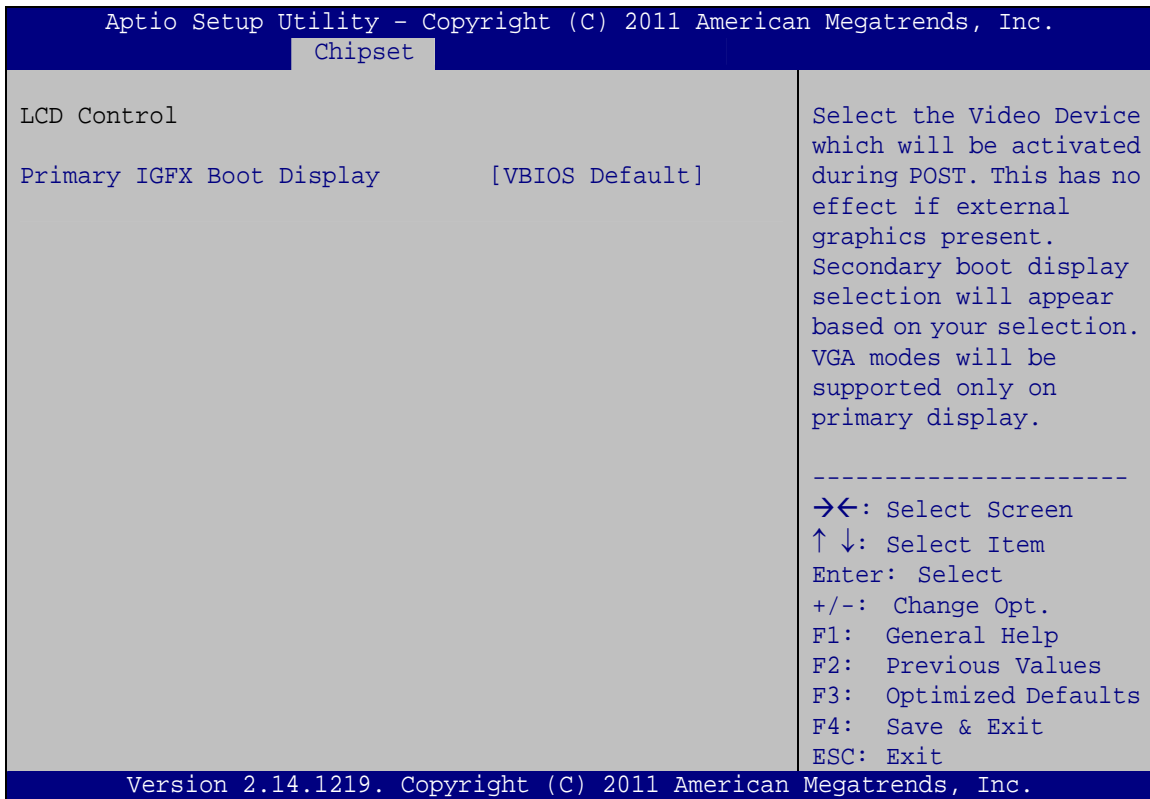

BIOS Menu 22: LCD Control

→ Primary IGFX Boot Display [VBIOS Default]

Use the **Primary IGFX Boot Display** option to select the display device used by the system when it boots. Configuration options are listed below.

- VBIOS **DEFAULT**
- CRT
- DVI

5.4.1.2 NB PCIe Configuration

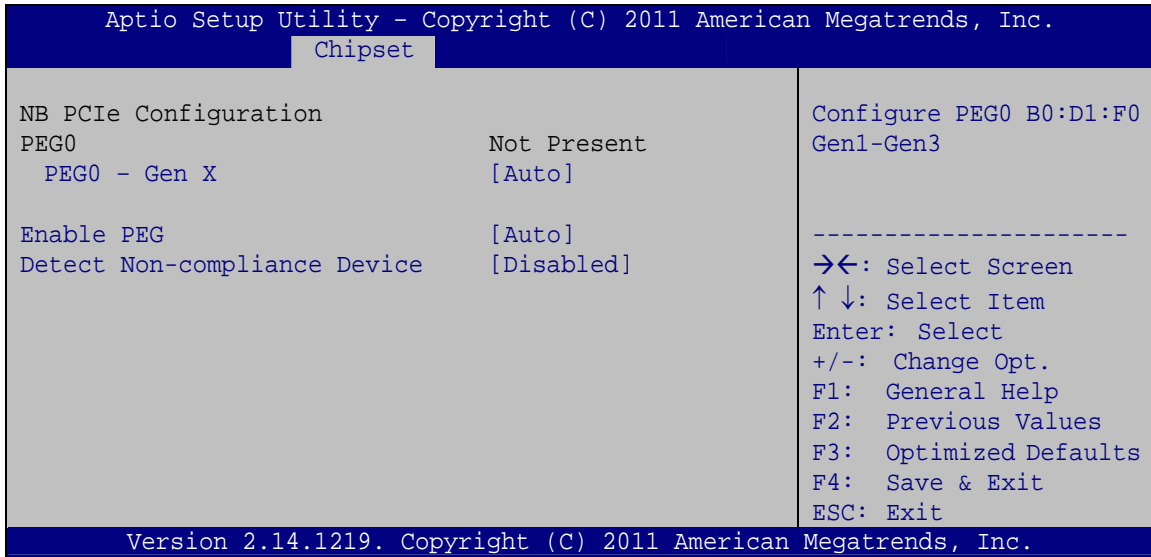

BIOS Menu 23: NB PCIe Configuration

→ PEG0 – Gen X [Auto]

Use the **PEG0 – Gen X** option to select the support type of the PCI Express (PEG) controller. The following options are available:

- Auto **Default**
- Gen1
- Gen2
- Gen3

→ Enable PEG [Auto]

Use the **Enable PEG** option to enable or disable the PCI Express (PEG) controller.

- **Disabled** Disables the PCI Express (PEG) controller.
- **Enabled** Enables the PCI Express (PEG) controller.
- **Auto** **DEFAULT** The PCI Express (PEG) controller is disabled if no PCI Express devices are connected.

SPCIE-C2060 PICMG 1.3 CPU Card

→ Detect Non-Compliance Device [Disabled]

Use the **Detect Non-Compliance Device** option to enable or disable detecting if a non-compliance PCI Express device is connected to the PCI Express port.

- **Disabled** **DEFAULT** Disables to detect if a non-compliance PCI Express device is connected to the PCI Express port.
- **Enabled** Enables to detect if a non-compliance PCI Express device is connected to the PCI Express port.

5.4.1.3 Memory Configuration

Use the **Memory Configuration** submenu (**BIOS Menu 24**) to view memory information.

```

Aptio Setup Utility - Copyright (C) 2011 American Megatrends, Inc.
  Chipset
-----
Memory Information
Total Memory          2048 MB (DDR3)
CHA_DIMM1             2048 MB (DDR3)
CHB_DIMM1             Not Present

-----
→←: Select Screen
↑ ↓: Select Item
Enter: Select
+/-: Change Opt.
F1: General Help
F2: Previous Values
F3: Optimized Defaults
F4: Save & Exit
ESC: Exit
-----
Version 2.14.1219. Copyright (C) 2011 American Megatrends, Inc.

```

BIOS Menu 24: Memory Configuration

5.4.2 PCH-IO Configuration

Use the **PCH-IO Configuration** menu (**BIOS Menu 25**) to configure the PCH parameters.

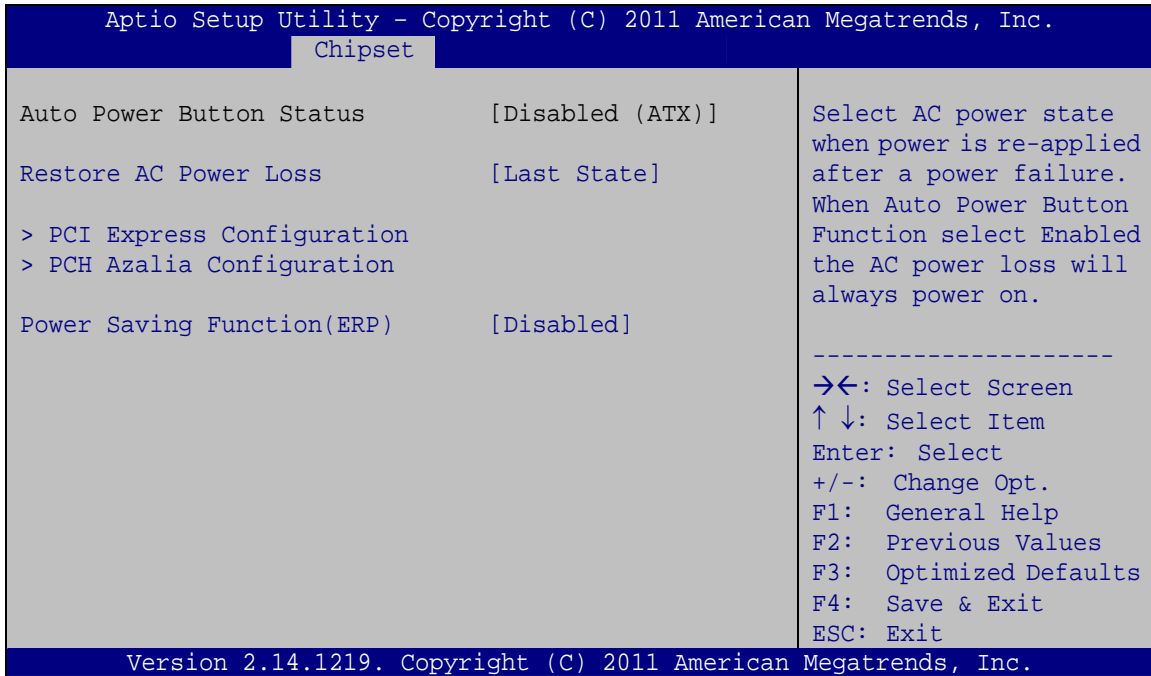

BIOS Menu 25: PCH-IO Configuration

→ Restore AC Power Loss [Last State]

Use the **Restore AC Power Loss** BIOS option to specify what state the system returns to if there is a sudden loss of power to the system.

- **Power Off** The system remains turned off
- **Power On** The system turns on
- **Last State** **DEFAULT** The system returns to its previous state. If it was on, it turns itself on. If it was off, it remains off.

→ Power Saving Function(ERP) [Disabled]

Use the **Power Saving Function(ERP)** BIOS option to enable or disable the power saving function.

- **Disabled** **DEFAULT** Power saving function is disabled.
- **Enabled** Power saving function is enabled. It will reduce power consumption when the system is off.

SPCIE-C2060 PICMG 1.3 CPU Card

5.4.2.1 PCI Express Configuration

Use the **PCI Express Configuration** menu (**BIOS Menu 23**) to select the support type of the PCI Express or PCIe Mini slots.

```

Aptio Setup Utility - Copyright (C) 2011 American Megatrends, Inc.
Chipset
PCI Express Configuration
> PCIEX1_1
> PCIEX1_2
> PCIEX1_3
> PCIEX1_4
> Mini PCIE

PCI Express Root Port 1
<PCIEX1_1> Settings.

-----
-><: Select Screen
↑↓: Select Item
Enter: Select
+/-: Change Opt.
F1: General Help
F2: Previous Values
F3: Optimized Defaults
F4: Save & Exit
ESC: Exit

Version 2.14.1219. Copyright (C) 2011 American Megatrends, Inc.

```

BIOS Menu 26: PCI Express Configuration

→ PCIEX1_1/ PCIEX1_2/ PCIEX1_3/ PCIEX1_4/Mini PCIE

Use this option to select the support type of the PCI Express or PCIe Mini slots. The following options are available:

- Auto **Default**
- Gen1
- Gen2

5.4.2.2 PCH Azalia Configuration

Use the **PCH Azalia Configuration** menu (**BIOS Menu 27**) to configure the PCH Azalia settings.

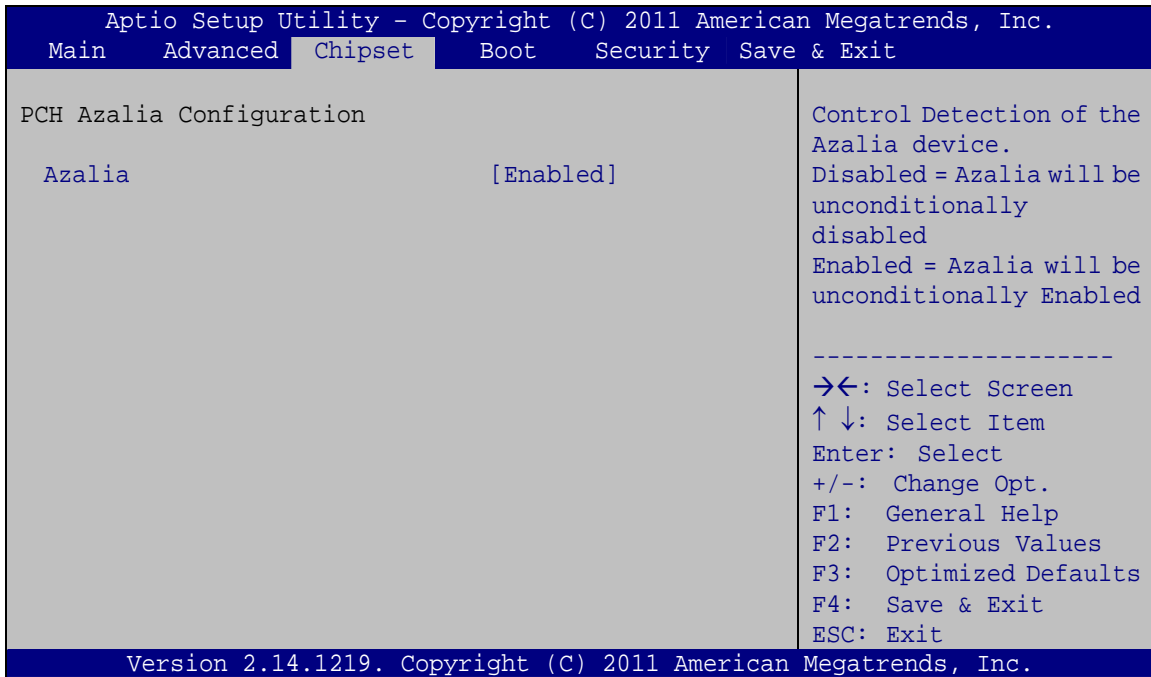

BIOS Menu 27: PCH Azalia Configuration Menu

➔ Azalia [Enabled]

Use the **Azalia** option to enable or disable the High Definition Audio controller.

- ➔ **Disabled** The onboard High Definition Audio controller is disabled
- ➔ **Enabled DEFAULT** The onboard High Definition Audio controller automatically detected and enabled

SPCIE-C2060 PICMG 1.3 CPU Card

5.5 Boot

Use the **Boot** menu (**BIOS Menu 28**) to configure system boot options.

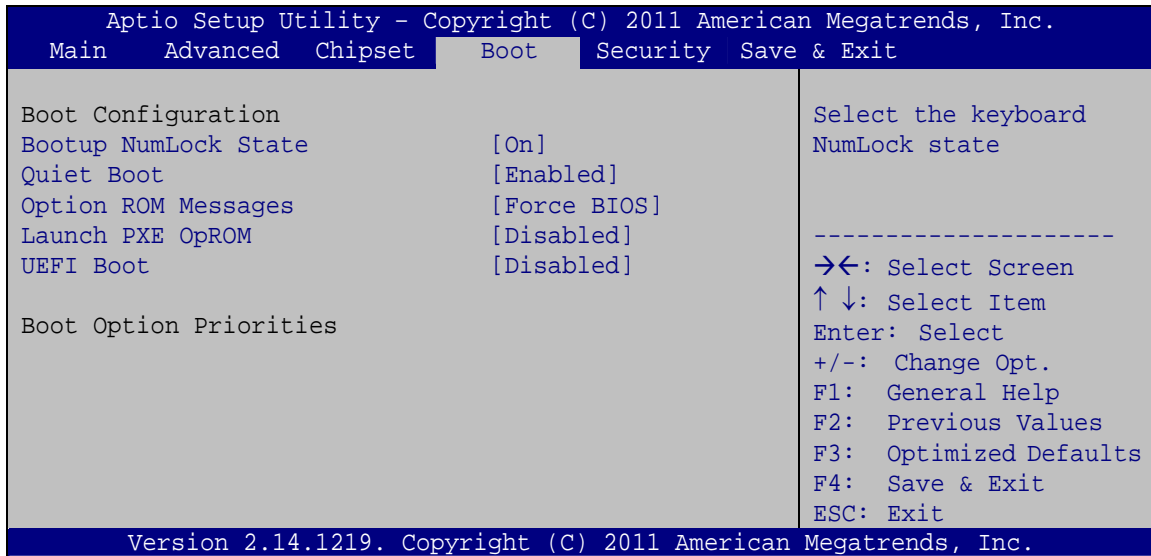

BIOS Menu 28: Boot

→ Bootup NumLock State [On]

Use the **Bootup NumLock State** BIOS option to specify if the number lock setting must be modified during boot up.

- **On** **DEFAULT** Allows the Number Lock on the keyboard to be enabled automatically when the computer system boots up. This allows the immediate use of the 10-key numeric keypad located on the right side of the keyboard. To confirm this, the Number Lock LED light on the keyboard is lit.
- **Off** Does not enable the keyboard Number Lock automatically. To use the 10-keys on the keyboard, press the Number Lock key located on the upper left-hand corner of the 10-key pad. The Number Lock LED on the keyboard lights up when the Number Lock is engaged.

→ Quiet Boot [Enabled]

Use the **Quiet Boot** BIOS option to select the screen display when the system boots.

- **Disabled** Normal POST messages displayed
- **Enabled** **DEFAULT** OEM Logo displayed instead of POST messages

→ Option ROM Messages [Force BIOS]

Use the **Option ROM Messages** option to set the Option ROM display mode.

- **Force BIOS** **DEFAULT** Sets display mode to force BIOS.
- **Keep Current** Sets display mode to current.

→ Launch PXE OpROM [Disabled]

Use the **Launch PXE OpROM** option to enable or disable boot option for legacy network devices.

- **Disabled** **DEFAULT** Ignore all PXE Option ROMs
- **Enabled** Load PXE Option ROMs.

→ UEFI Boot [Disabled]

Use the **UEFI Boot** option to enable or disable to boot from the UEFI devices.

- **Enabled** Boot from UEFI devices is enabled.
- **Disabled** **DEFAULT** Boot from UEFI devices is disabled.

SPCIE-C2060 PICMG 1.3 CPU Card

5.6 Security

Use the **Security** menu (**BIOS Menu 29**) to set system and user passwords.

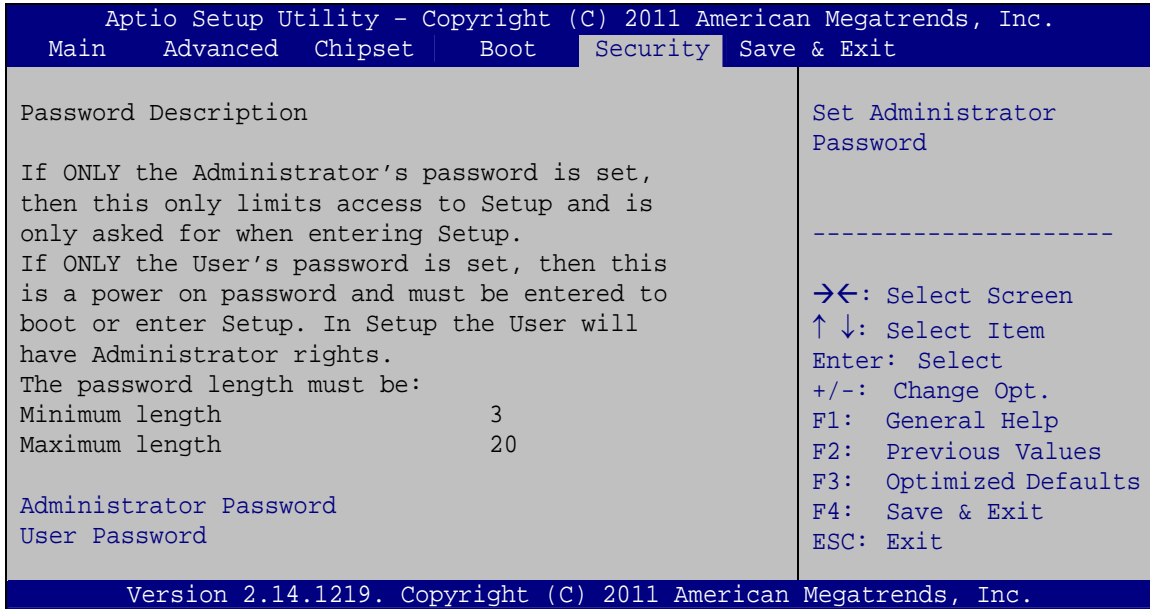

BIOS Menu 29: Security

➔ Administrator Password

Use the **Administrator Password** to set or change a administrator password.

➔ User Password

Use the **User Password** to set or change a user password.

5.7 Save & Exit

Use the **Save & Exit** menu (**BIOS Menu 30**) to load default BIOS values, optimal failsafe values and to save configuration changes.

```
Aptio Setup Utility - Copyright (C) 2011 American Megatrends, Inc.
Main   Advanced  Chipset  Boot   Security  Save & Exit

Save Changes and Reset
Discard Changes and Reset

Restore Defaults
Save as User Defaults
Restore User Defaults

Exit the system after
saving the changes.

-----

-><: Select Screen
↑ ↓: Select Item
Enter: Select
+/-: Change Opt.
F1: General Help
F2: Previous Values
F3: Optimized Defaults
F4: Save & Exit
ESC: Exit

Version 2.14.1219. Copyright (C) 2011 American Megatrends, Inc.
```

BIOS Menu 30: Save & Exit

→ Save Changes and Reset

Use the **Save Changes and Reset** option to save the changes made to the BIOS options and reset the system.

→ Discard Changes and Reset

Use the **Discard Changes and Reset** option to exit the system without saving the changes made to the BIOS configuration setup program.

→ Restore Defaults

Use the **Restore Defaults** option to load the optimal default values for each of the parameters on the Setup menus. **F3 key can be used for this operation.**

SPCIE-C2060 PICMG 1.3 CPU Card

→ **Save as User Defaults**

Use the **Save as User Defaults** option to save the changes done so far as user defaults.

→ **Restore User Defaults**

Use the **Restore User Defaults** option to restore the user defaults to all the setup options.

Chapter

6

Software Drivers

SPCIE-C2060 PICMG 1.3 CPU Card

6.1 Available Software Drivers

**NOTE:**

The content of the CD may vary throughout the life cycle of the product and is subject to change without prior notice. Visit the IEI website or contact technical support for the latest updates.

The following drivers can be installed on the system:

- Chipset
- VGA
- LAN
- Audio
- SATA (Intel® Rapid Storage Technology)
- Intel® AMT
 - Intel® Management Engine Components driver
 - Intel® IT Director application

Installation instructions are given below.

6.2 Software Installation

All the drivers for the SPCIE-C2060 Series are on the CD that came with the system. To install the drivers, please follow the steps below.

Step 1: Insert the CD into a CD drive connected to the system.

**NOTE:**

If the installation program doesn't start automatically:
Click "Start->My Computer->CD Drive->autorun.exe"

Step 2: The driver main menu appears (**Figure 6-1**).



Figure 6-1: Introduction Screen

Step 3: Click SPCIE-C2060.

Step 4: A new screen with a list of available drivers appears (**Figure 6-2**).



Figure 6-2: Available Drivers

SPCIE-C2060 PICMG 1.3 CPU Card

Step 5: Install all of the necessary drivers in this menu.

6.3 Chipset Driver Installation

To install the chipset driver, please do the following.

Step 1: Access the driver list. (See **Section 6.2**)

Step 2: Click “1-Chipset”.

Step 3: Locate the setup file and double click on it.

Step 4: The setup files are extracted as shown in **Figure 6-3**.



Figure 6-3: Chipset Driver Screen

Step 5: When the setup files are completely extracted the **Welcome Screen** in **Figure 6-4** appears.

Step 6: Click **Next** to continue.



Figure 6-4: Chipset Driver Welcome Screen

Step 7: The license agreement in **Figure 6-5** appears.

Step 8: Read the **License Agreement**.

Step 9: Click **Yes** to continue.



Figure 6-5: Chipset Driver License Agreement

Step 10: The **Read Me** file in **Figure 6-6** appears.

SPCIE-C2060 PICMG 1.3 CPU Card

Step 11: Click **Next** to continue.



Figure 6-6: Chipset Driver Read Me File

Step 12: **Setup Operations** are performed as shown in **Figure 6-7**.

Step 13: Once the **Setup Operations** are complete, click **Next** to continue.



Figure 6-7: Chipset Driver Setup Operations

Step 14: The **Finish** screen in **Figure 6-8** appears.

Step 15: Select “**Yes, I want to restart this computer now**” and click **Finish**.



Figure 6-8: Chipset Driver Installation Finish Screen

6.4 Graphics Driver Installation

To install the Graphics driver, please do the following.

Step 1: Access the driver list. (See **Section 6.2**)

Step 2: Click “**2-VGA**” and select the folder which corresponds to the operating system.

Step 3: Double click the setup file.

Step 4: The **Welcome Screen** in **Figure 6-9** appears.

Step 5: Click **Next** to continue.

SPCIE-C2060 PICMG 1.3 CPU Card

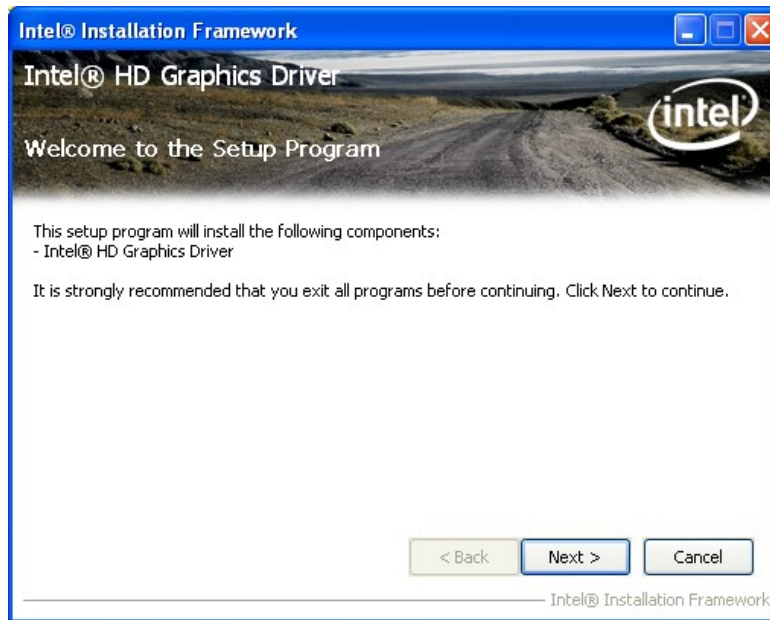

Figure 6-9: Graphics Driver Welcome Screen

Step 6: The License Agreement in Figure 6-10 appears.

Step 7: Click **Yes** to accept the agreement and continue.



Figure 6-10: Graphics Driver License Agreement

Step 8: The Read Me file in Figure 6-11 appears. Click **Next** to continue.

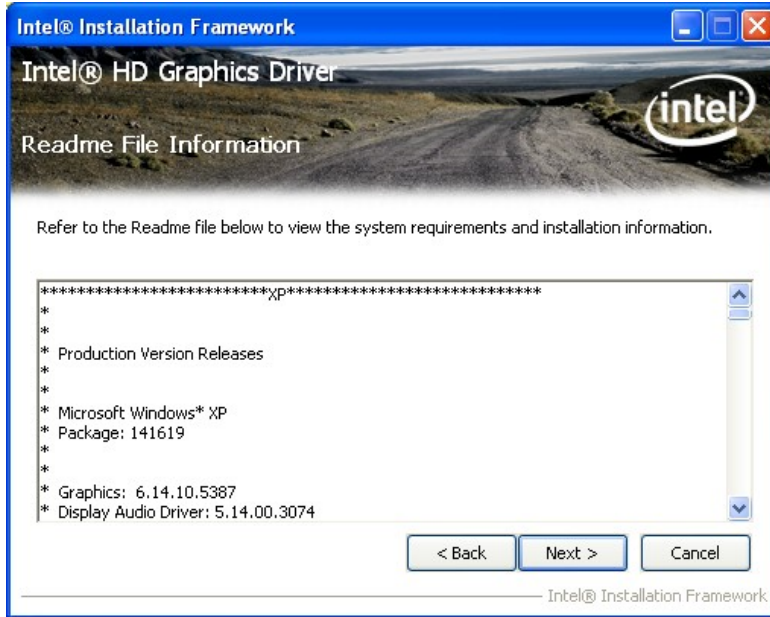

Figure 6-11: Graphics Driver Read Me File

Step 9: **Setup Operations** are performed as shown in **Figure 6-12**.

Step 10: Once the **Setup Operations** are complete, click **Next** to continue.

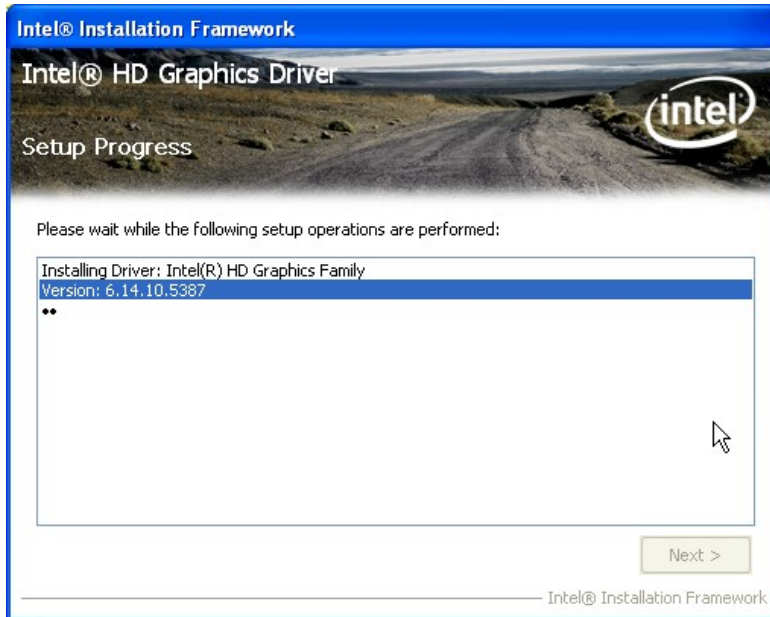

Figure 6-12: Graphics Driver Setup Operations

Step 11: The **Finish** screen in **Figure 6-13** appears.

SPCIE-C2060 PICMG 1.3 CPU Card

Step 12: Select “Yes, I want to restart this computer now” and click **Finish**.

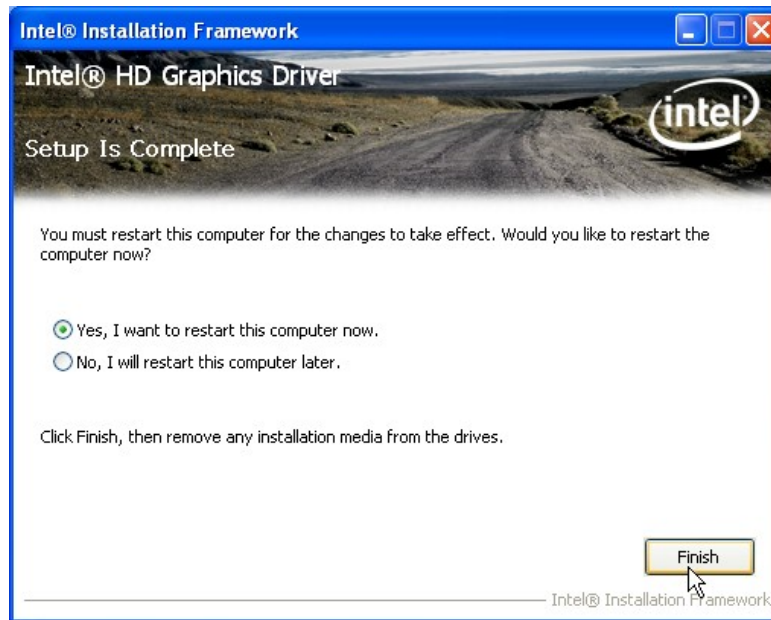

Figure 6-13: Graphics Driver Installation Finish Screen

6.5 LAN Driver Installation

To install the LAN driver, please do the following.

Step 1: Access the driver list. (See **Section 6.2**)

Step 2: Click “**3-LAN**”.

Step 3: Locate the Autorun file and double click it.

Step 4: The Intel® Network Connection menu in **Figure 6-14** appears.

Step 5: Click **Install Drivers and Software**.

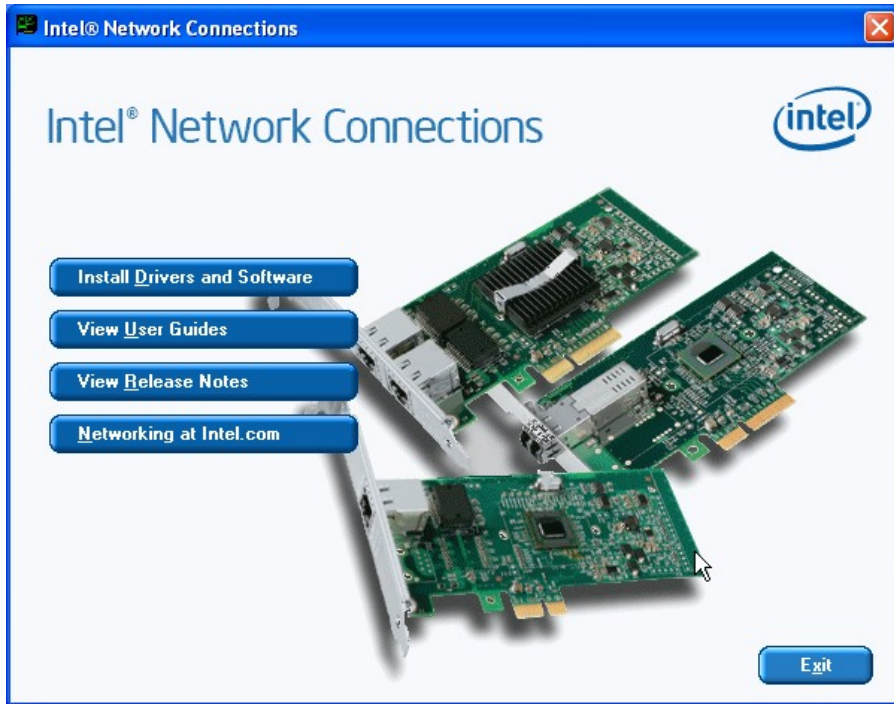

Figure 6-14: Intel® Network Connection Menu

Step 6: The **Welcome** screen in **Figure 6-15** appears.

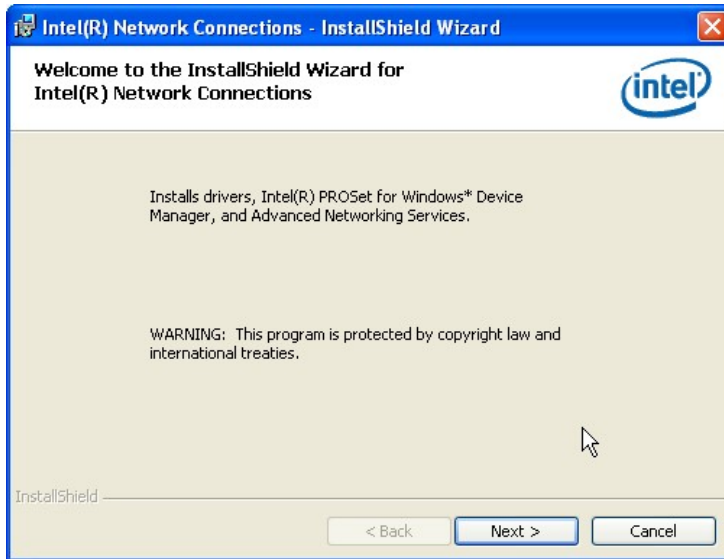

Figure 6-15: LAN Driver Welcome Screen

Step 7: Click **Next** to continue.

Step 8: The **License Agreement** in **Figure 6-16** appears.

SPCIE-C2060 PICMG 1.3 CPU Card

Step 9: Accept the agreement by selecting “I accept the terms in the license agreement”.

Step 10: Click **Next** to continue.



Figure 6-16: LAN Driver License Agreement

Step 11: The **Setup Options** screen in **Figure 6-17** appears.

Step 12: Select program features to install.

Step 13: Click **Next** to continue.

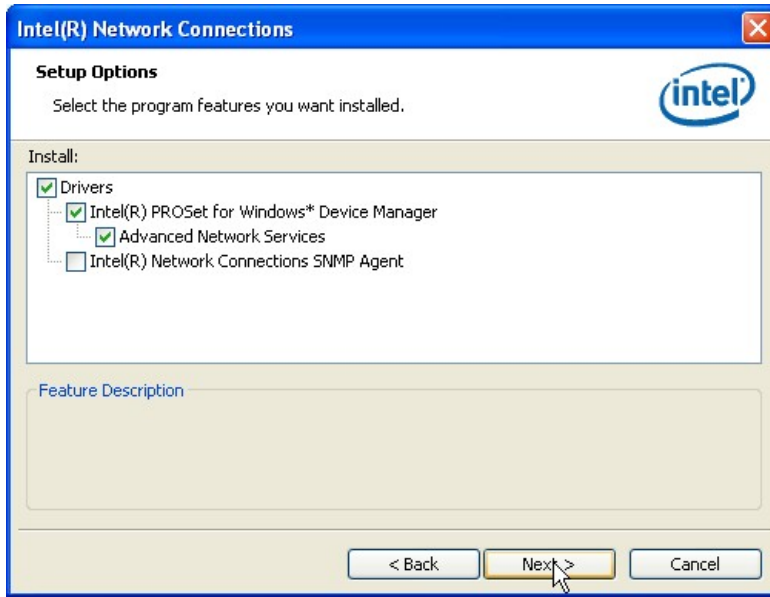

Figure 6-17: LAN Driver Setup Options

Step 14: The **Ready to Install the Program** screen in **Figure 6-18** appears.

Step 15: Click **Install** to proceed with the installation.

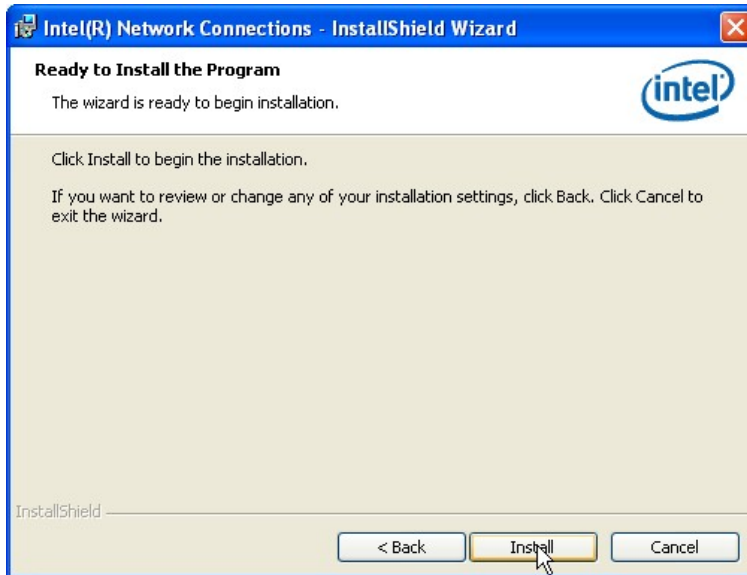

Figure 6-18: LAN Driver Installation

Step 16: The program begins to install.

Step 17: When the driver installation is complete, the screen in **Figure 6-19** appears.

SPCIE-C2060 PICMG 1.3 CPU Card

Step 18: Click **Finish** to exit.



Figure 6-19: LAN Driver Installation Complete

6.6 Audio Driver Installation

To install the audio driver, please do the following.

- Step 1:** Access the driver list. (See **Section 6.2**)
- Step 2:** Click "**4-Audio**" and select the folder which corresponds to the operating system.
- Step 3:** Double click the setup file.
- Step 4:** The **InstallShield Wizard** is prepared to guide the user through the rest of the process.
- Step 5:** Once initialized, the **InstallShield Wizard** welcome screen appears (**Figure 6-20**).

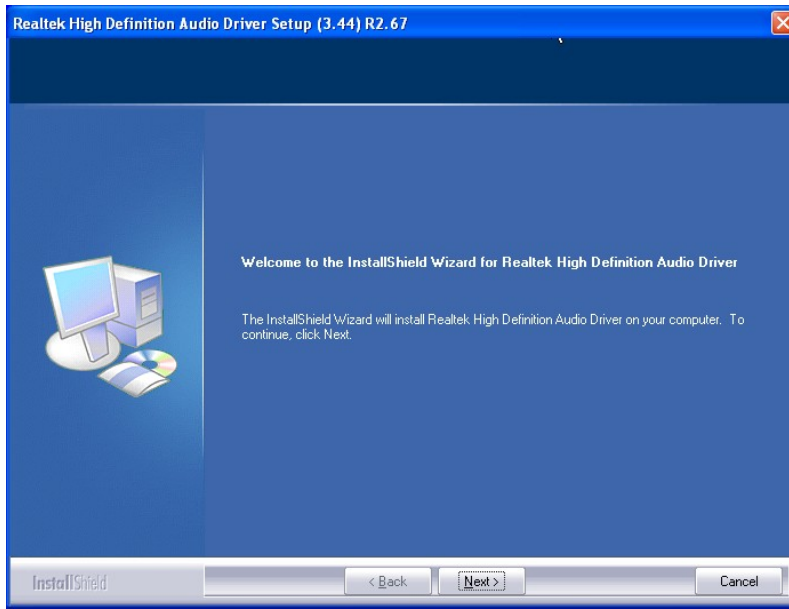

Figure 6-20: InstallShield Wizard Welcome Screen

Step 6: Click **Next** to continue the installation.

Step 7: InstallShield starts to install the new software as shown in **Figure 6-21**.

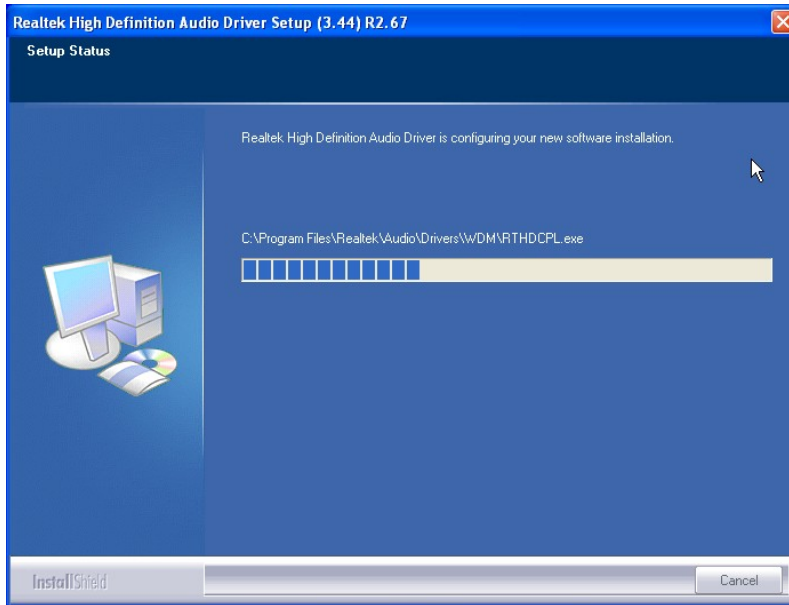

Figure 6-21: Audio Driver Software Configuration

Step 8: After the driver installation process is complete, a confirmation screen appears (Figure 6-22).

SPCIE-C2060 PICMG 1.3 CPU Card

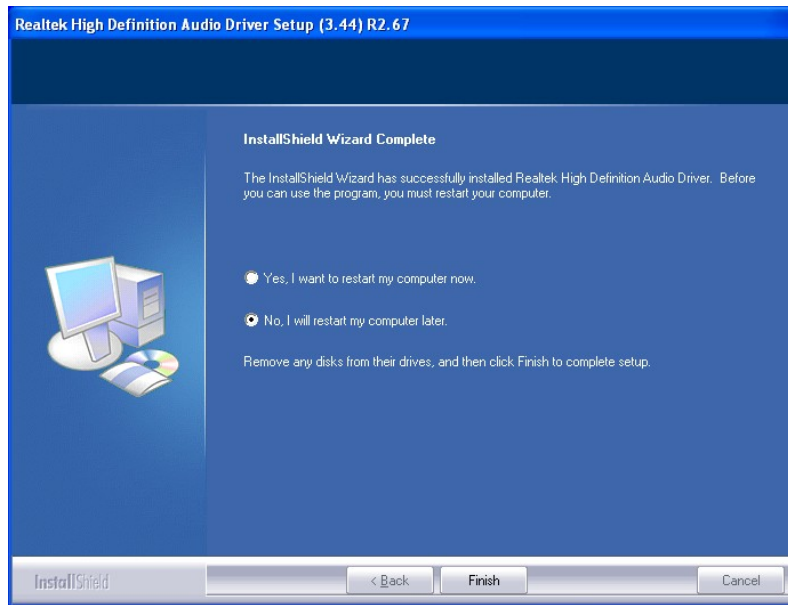

Figure 6-22: Restart the Computer

- Step 9:** The confirmation screen offers the option of restarting the computer now or later. For the settings to take effect, the computer must be restarted. Click **Finish** to restart the computer.

6.7 Intel® Rapid Storage Technology Driver Installation

To install the Intel® Rapid Storage Technology driver, please do the following.

- Step 1:** Access the driver list. (See **Section 6.2**)
- Step 2:** Click “**5-SATA**”.
- Step 3:** Locate the setup file and double click on it.
- Step 4:** The **Welcome Screen** in **Figure 6-23** appears.
- Step 5:** Click **Next** to continue.

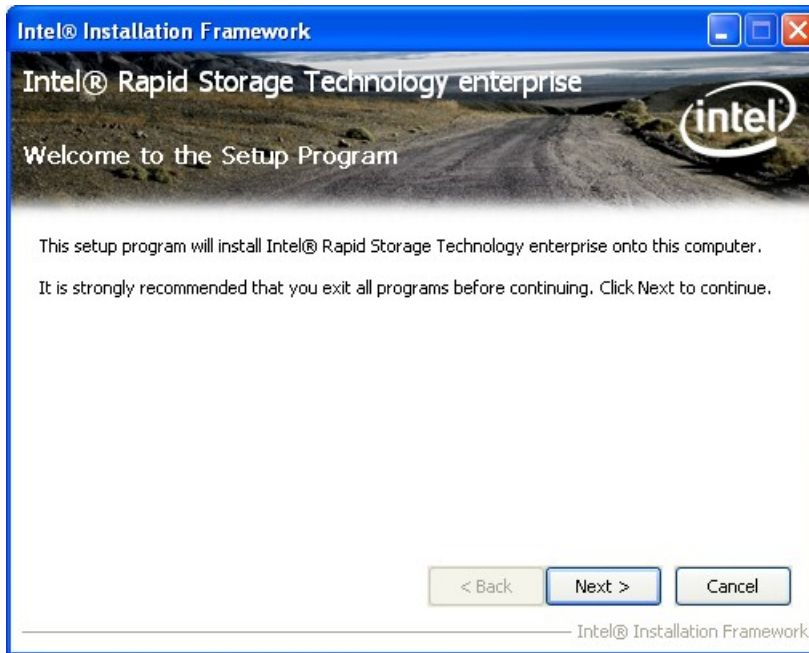

Figure 6-23: SATA RAID Driver Welcome Screen

Step 6: The **Warning** screen in **Figure 6-24** appears.

Step 7: Click **Next** to continue.



Figure 6-24: SATA RAID Driver Warning

SPCIE-C2060 PICMG 1.3 CPU Card

Step 8: The license agreement in **Figure 6-25** appears.

Step 9: Read the **License Agreement**.

Step 10: Click **Yes** to continue.



Figure 6-25: SATA RAID Driver License Agreement

Step 11: The **Read Me** file in **Figure 6-26** appears.

Step 12: Click **Next** to continue.

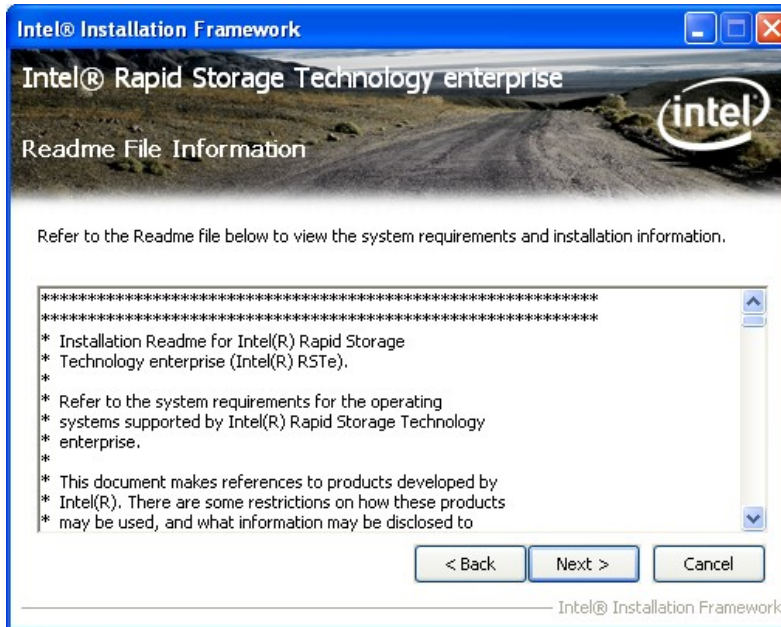

Figure 6-26: SATA RAID Driver Read Me File

Step 13: Once the **Setup Operations** are complete, click **Next** to continue (Figure 6-27).

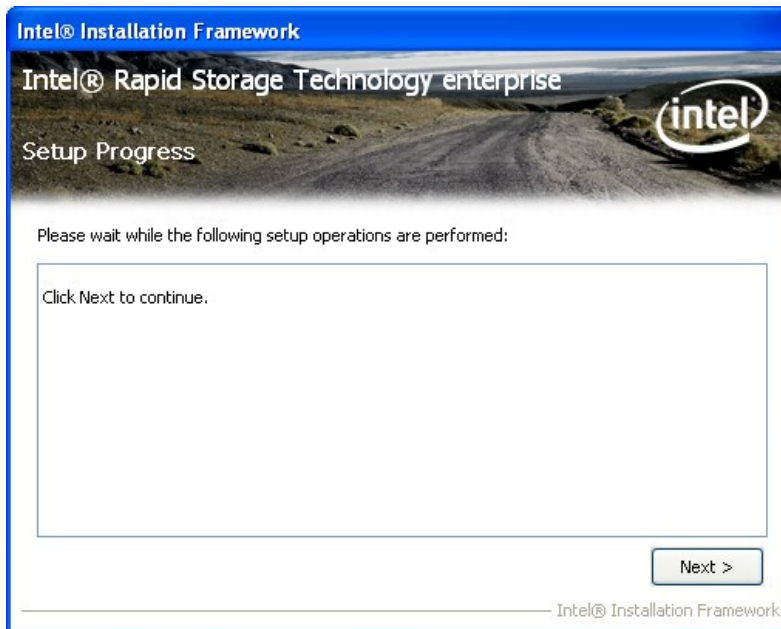

Figure 6-27: SATA RAID Driver Setup Operations

Step 14: The **Finish** screen in Figure 6-28 appears.

SPCIE-C2060 PICMG 1.3 CPU Card

Step 15: Select “Yes, I want to restart this computer now” and click **Finish**.

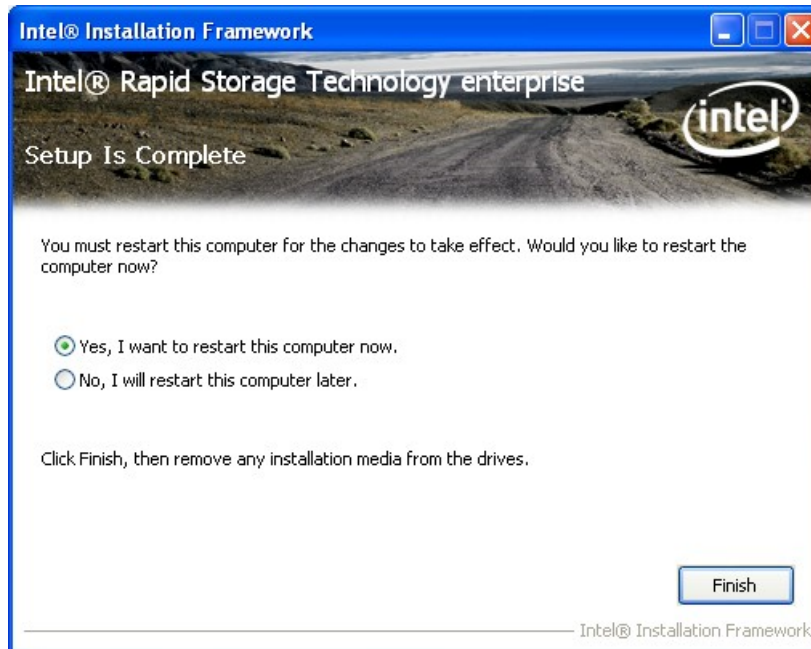

Figure 6-28: SATA RAID Driver Installation Finish Screen

6.8 Intel® AMT Driver and Application

6.8.1 Intel® Management Engine Components Installation

The package of the Intel® ME components includes

- Intel® Management Engine Interface (Intel® ME Interface)
- Serial Over LAN (SOL) driver
- Local Manageability Service (LMS)
- User Notification Service (UNS)
- Intel® ME WMI provider
- Intel® Active Management Technology NAC Posture Plug-in
- Intel Control Center
- Intel® Management and Security Status Application

To install these Intel® ME components, please do the following.

Step 1: Access the driver list. (See **Section 6.2**)

Step 2: Click “7-iAMT”.

Step 3: Double click the setup file in the **MEI_alIOS_xx_PV** folder.

Step 4: Locate the setup file and double click it.

Step 5: When the setup files are completely extracted the **Welcome Screen** in **Figure 6-29** appears.

Step 6: Click **Next** to continue.

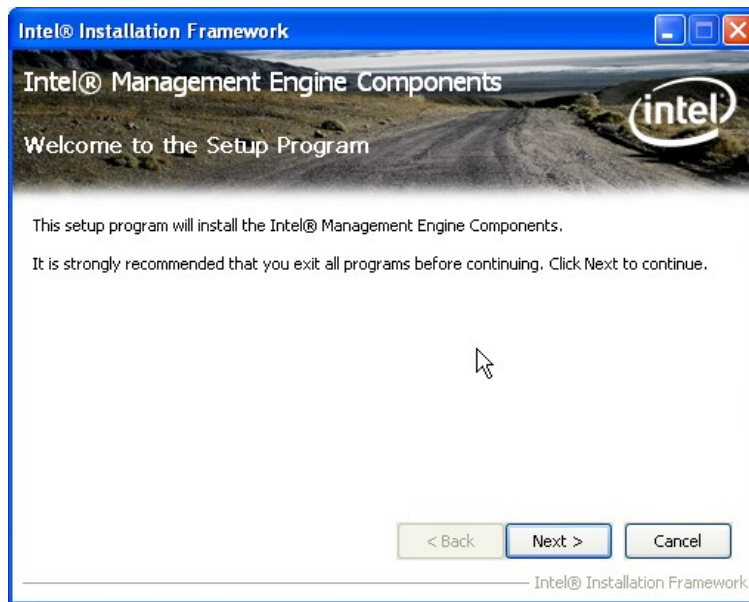

Figure 6-29: Intel® ME Driver Welcome Screen

Step 7: The license agreement in **Figure 6-30** appears.

Step 8: Read the **License Agreement**.

Step 9: Click **Yes** to continue.

SPCIE-C2060 PICMG 1.3 CPU Card



Figure 6-30: Intel® ME Driver License Agreement

Step 10: The Read Me file in Figure 6-31 appears.

Step 11: Click **Next** to continue.

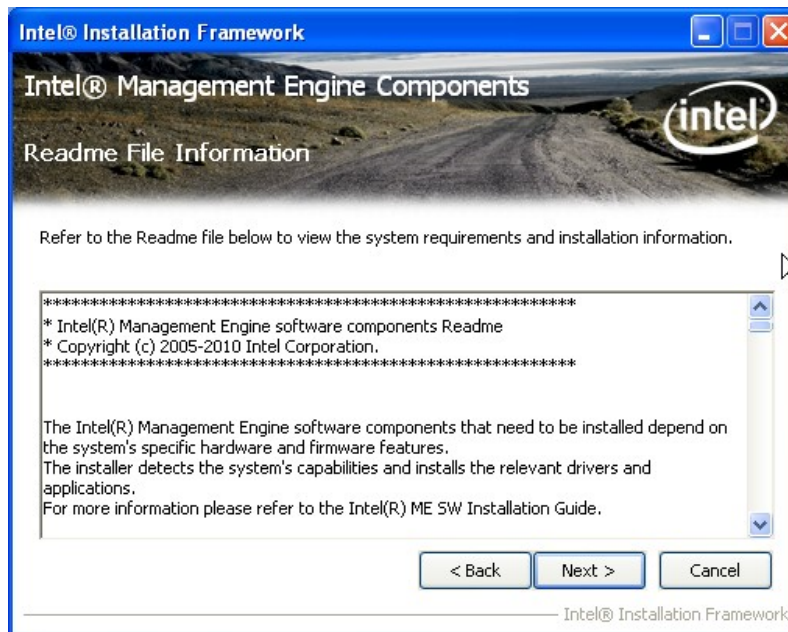

Figure 6-31: Intel® ME Driver Read Me File

Step 12: Setup Operations are performed as shown in Figure 6-32.

Step 13: Once the Setup Operations are complete, click **Next** to continue.

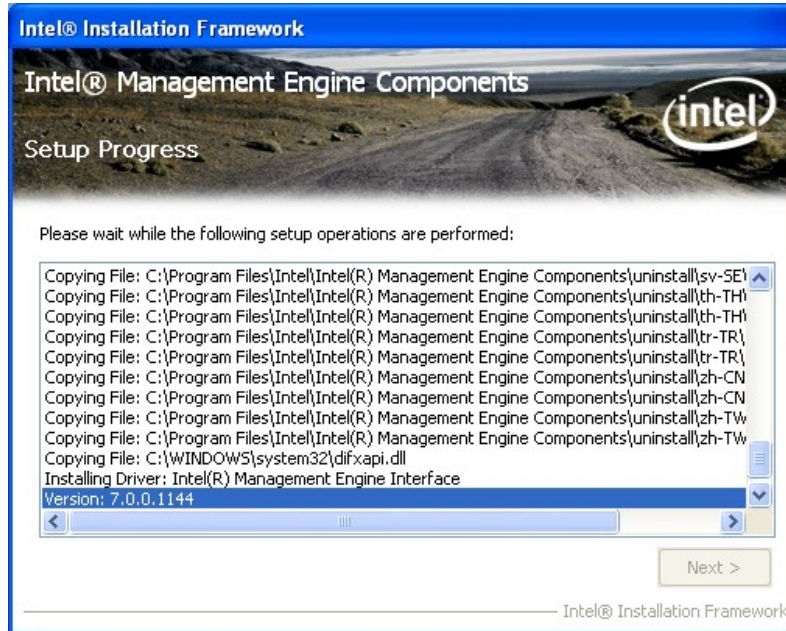

Figure 6-32: Intel® ME Driver Setup Operations

Step 14: The **Finish** screen in Figure 6-33 appears.

Step 15: Select “**Yes, I want to restart this computer now**” and click **Finish**.

SPCIE-C2060 PICMG 1.3 CPU Card

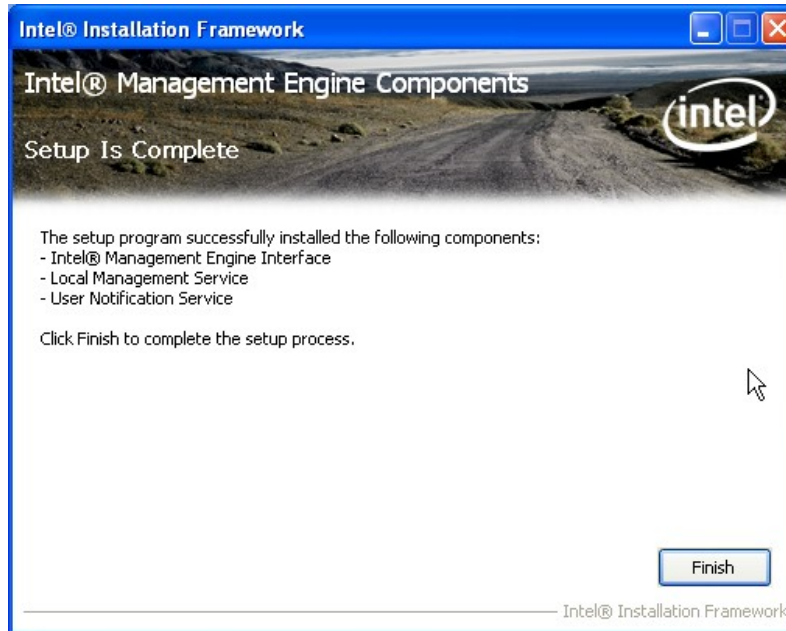

Figure 6-33: Intel® ME Driver Installation Finish Screen

6.8.2 Intel® IT Director Application Installation

Intel® IT Director is an application that helps address key IT security, data protection and network health concerns of small businesses. To install the Intel® IT Director application, please do the following.



NOTE:

For Windows XP system, please make sure to install the .net Framework 3.5 before installing the Intel® IT Director application. The .net Framework 3.5 setup file is located at `\7-iAMT, iTPM Driver & Utility\Microsoft .NET Framework 3.5` of the driver CD.

Step 1: Access the driver list. (See **Section 6.2**)

Step 2: Click "7-iAMT".

Step 3: Double click the setup file in the **Intel_ IT Director** folder.

Step 4: Locate the **ITDirector_Setup.exe** setup file and double click it.

Step 5: The **Welcome Screen** in **Figure 6-34** appears.

Step 6: Click **Next** to continue.



Figure 6-34: IT Director Welcome Screen

Step 7: The license agreement in **Figure 6-35** appears.

Step 8: Accept the agreement by selecting “I accept the terms in the license agreement”.

Step 9: Click **Next** to continue.

SPCIE-C2060 PICMG 1.3 CPU Card



Figure 6-35: IT Director License Agreement

Step 10: Continue to choose the installation type and the destination folder for the IT Director application.

Step 11: The **Ready to Install the Program** screen in **Figure 6-36** appears.

Step 12: Click **Install** to proceed with the installation.

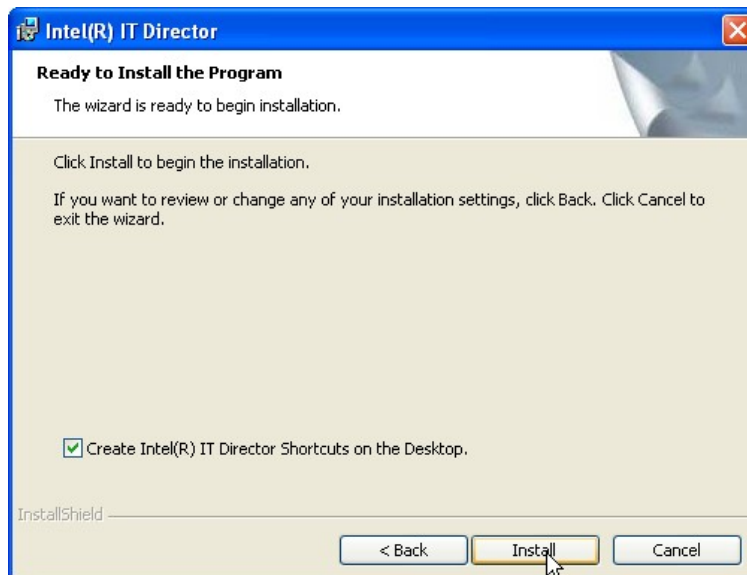

Figure 6-36: IT Director Installation

Step 13: The program begins to install.

Step 14: When the driver installation is complete, the screen in **Figure 6-37** appears.

Step 15: Click **Next** to configure the system for remote monitoring or **Cancel** to exit the program and configure the system later.

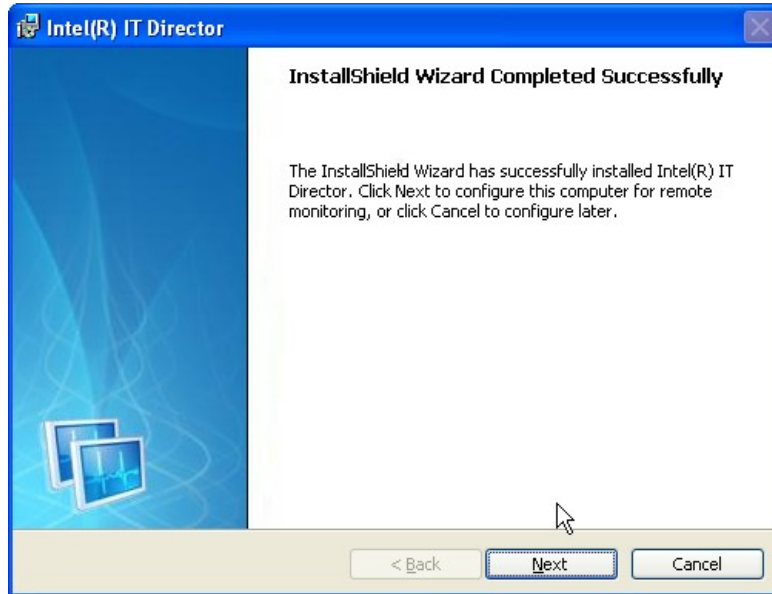

Figure 6-37: IT Director Installation Complete

Step 16: The Welcome Screen of the IT Director Configuration Tool in **Figure 6-38** appears.

SPCIE-C2060 PICMG 1.3 CPU Card



Figure 6-38: IT Director Configuration Tool Welcome Screen

**NOTE:**

It is recommended to open the [Intel® IT Director Getting Started Guide](#) shown in **Figure 6-38** to fully understand the configuration process.

Step 17: Select whether this is the first computer you are creating a password for IT Director. (**Figure 6-39**).

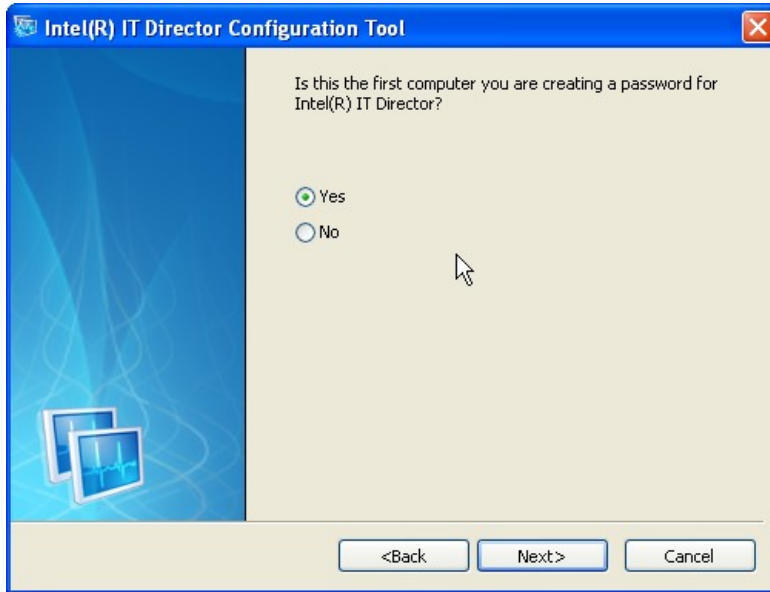

Figure 6-39: IT Director – Creating Password

Step 18: Follow the instructions to create a new password or enter the password created previously.

Step 19: When the configuration is complete, the screen in **Figure 6-40** appears.

Step 20: Click **Finish** to exit.



Figure 6-40: IT Director Configuration Complete



NOTE:

If the network connection doesn't work after installing the Intel® IT Director in a Windows Vista system, please install the network adapter driver. The driver is located at **V7-iAMT, iTPM Driver & Utility\AMT Hot Fix\V1.0C0206** of the driver CD. Follow the instruction in the Intel Website Message PDF file in the same folder to install the driver.

Appendix

A

BIOS Options

SPCIE-C2060 PICMG 1.3 CPU Card

Below is a list of BIOS configuration options in the BIOS chapter.

System Overview	67
System Date [xx/xx/xx]	67
System Time [xx:xx:xx]	67
ACPI Sleep State [S1 only (CPU Stop Clock)]	69
Wake system with Fixed Time [Disabled]	70
Security Device Support [Disable]	71
Intel Virtualization Technology [Disabled]	72
SATA Controller(s) [Enabled]	73
SATA Mode Selection [IDE]	73
Intel AMT [Enabled]	75
Un-Configure ME [Disabled]	75
USB Devices	76
Legacy USB Support [Enabled]	76
Serial Port [Enabled]	78
Change Settings [Auto]	78
Serial Port [Enabled]	78
Change Settings [Auto]	79
Serial Port [Enabled]	79
Change Settings [Auto]	79
Serial Port [Enabled]	80
Change Settings [Auto]	80
Serial Port [Enabled]	81
Change Settings [Auto]	81
IrDA [Enabled]	82
Change Settings [Auto]	82
Parallel Port [Enabled]	83
Change Settings [Auto]	84
Device Mode [STD Printer Mode]	84
PC Health Status	85
CPU_FAN1 Smart Fan Control [Auto Duty-Cycle Mode]	86
CPU Temperature n	86
Console Redirection [Disabled]	87
Terminal Type [ANSI]	87

Bits per second [115200].....	88
Data Bits [8]	88
Parity [None].....	88
Stop Bits [1].....	89
Auto Recovery Function [Disabled].....	89
VT-d [Disabled].....	91
Primary Display [Auto]	92
DVMT Pre-Allocated [256M]	92
DVMT Total Gfx Mem [MAX].....	93
Primary IGFX Boot Display [VBIOS Default]	93
PEG0 – Gen X [Auto]	94
Enable PEG [Auto].....	94
Detect Non-Compliance Device [Disabled]	95
Restore AC Power Loss [Last State]	96
Power Saving Function(ERP) [Disabled].....	96
PCIEX1_1/ PCIEX1_2/ PCIEX1_3/ PCIEX1_4/Mini PCIE.....	97
Azalia [Enabled]	98
Bootup NumLock State [On].....	99
Quiet Boot [Enabled]	100
Option ROM Messages [Force BIOS].....	100
Launch PXE OpROM [Disabled]	100
UEFI Boot [Disabled]	100
Administrator Password	101
User Password	101
Save Changes and Reset	102
Discard Changes and Reset	102
Restore Defaults	102
Save as User Defaults	103
Restore User Defaults	103

Appendix

B

One Key Recovery

B.1 One Key Recovery Introduction

The IEI one key recovery is an easy-to-use front end for the Norton Ghost system backup and recovery tool. This tool provides quick and easy shortcuts for creating a backup and reverting to that backup or reverting to the factory default settings.



NOTE:

The latest One Key Recovery software provides an auto recovery function that allows a system running Microsoft Windows OS to automatically restore from the factory default image after encountering a Blue Screen of Death (BSoD) or a hang for around 10 minutes. Please refer to Section B.3 for the detailed setup procedure.

The IEI One Key Recovery tool menu is shown below.

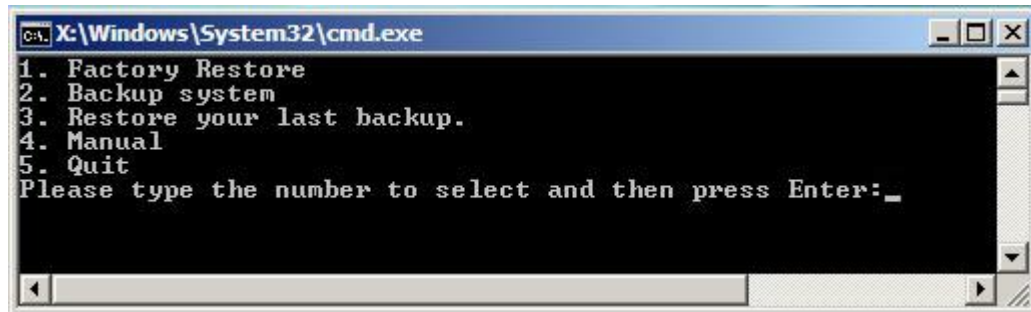

Figure B-1: IEI One Key Recovery Tool Menu

Prior to using the IEI One Key Recovery tool (as shown in **Figure B-1**) to backup or restore Windows system, five setup procedures are required.

1. Hardware and BIOS setup (see Section B.2.1)
2. Create partitions (see **Section B.2.2**)
3. Install operating system, drivers and system applications (see **Section B.2.3**)
4. Build-up recovery partition (see **Section B.2.4**)
5. Create factory default image (see **Section B.2.5**)

SPCIE-C2060 PICMG 1.3 CPU Card

After completing the five initial setup procedures as described above, users can access the recovery tool by pressing <F3> while booting up the system. The detailed information of each function is described in **Section B.5**.



NOTE:

The initial setup procedures for Linux system are described in **Section B.3**.

B.1.1 System Requirement



NOTE:

The recovery CD can only be used with IEI products. The software will fail to run and a warning message will appear when used on non-IEI hardware.

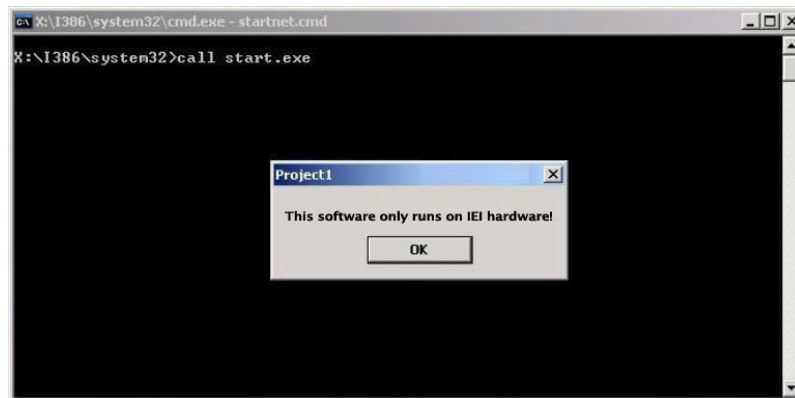

To create the system backup, the main storage device must be split into two partitions (three partitions for Linux). The first partition will be for the operating system, while the second partition will be invisible to the operating system and contain the backup made by the one key recovery software.

The partition created for recovery images must be big enough to contain both the factory default image and the user backup image. The size must be calculated before creating the

partitions. Please take the following table as a reference when calculating the size of the partition.

	OS	OS Image after Ghost	Compression Ratio
Windows® 7	7 GB	5 GB	70%
Windows® XPE	776 MB	560 MB	70%
Windows® CE 6.0	36 MB	28 MB	77%

**NOTE:**

Specialized tools are required to change the partition size if the operating system is already installed.

B.1.2 Supported Operating System

The recovery CD is compatible with both Microsoft Windows and Linux operating system (OS). The supported OS versions are listed below.

- Microsoft Windows
 - Windows 2000
 - Windows XP (Service Pack 2 or 3 required)
 - Windows Vista
 - Windows 7
 - Windows CE 5.0
 - Windows CE 6.0
 - Windows XP Embedded
 - Windows Embedded Standard 7

**NOTE:**

The auto recovery function (described in Section B.3) and the restore through LAN function (described in Section B.6) are not supported in the Windows CE 5.0/6.0 operating system environment.

SPCIE-C2060 PICMG 1.3 CPU Card

- Linux
 - Fedora Core 12 (Constantine)
 - Fedora Core 11 (Leonidas)
 - Fedora Core 10 (Cambridge)
 - Fedora Core 8 (Werewolf)
 - Fedora Core 7 (Moonshine)
 - RedHat RHEL-5.4
 - RedHat 9 (Ghirke)
 - Ubuntu 8.10 (Intrepid)
 - Ubuntu 7.10 (Gutsy)
 - Ubuntu 6.10 (Edgy)
 - Debian 5.0 (Lenny)
 - Debian 4.0 (Etch)
 - SuSe 11.2
 - SuSe 10.3



NOTE:

Installing unsupported OS versions may cause the recovery tool to fail.

B.2 Setup Procedure for Windows

Prior to using the recovery tool to backup or restore, a few setup procedures are required.

Step 1: Hardware and BIOS setup (see Section **B.2.1**)

Step 2: Create partitions (see **Section B.2.2**)

Step 3: Install operating system, drivers and system applications (see **Section B.2.3**)

Step 4: Build the recovery partition (see **Section B.2.4**) or build the auto recovery partition (see **Section B.3**)

Step 5: Create factory default image (see **Section B.2.5**)

The detailed descriptions are described in the following sections.

**NOTE:**

The setup procedures described below are for Microsoft Windows operating system users. For Linux, most of the setup procedures are the same except for several steps described in **Section B.3**.

B.2.1 Hardware and BIOS Setup

- Step 1:** Make sure the system is powered off and unplugged.
- Step 2:** Install a hard drive or SSD in the system. An unformatted and unpartitioned disk is recommended.
- Step 3:** Connect an optical disk drive to the system and insert the recovery CD.
- Step 4:** Turn on the system.
- Step 5:** Press the <DELETE> key as soon as the system is turned on to enter the BIOS.
- Step 6:** Select the connected optical disk drive as the 1st boot device. (**Boot → Boot Device Priority → 1st Boot Device**).
- Step 7:** Save changes and restart the computer. Continue to the next section for instructions on partitioning the internal storage.

B.2.2 Create Partitions

To create the system backup, the main storage device must be split into two partitions (three partitions for Linux). The first partition will be for the operating system, while the second partition will be invisible to the operating system and contain the backup made by the one key recovery software.

- Step 1:** Put the recovery CD in the optical drive of the system.

SPCIE-C2060 PICMG 1.3 CPU Card

Step 2: Boot the system from recovery CD. When prompted, press any key to boot from the recovery CD. It will take a while to launch the recovery tool. Please be patient!

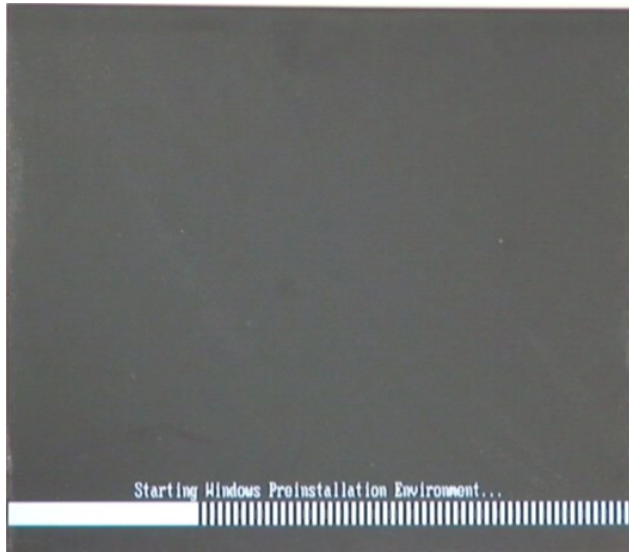

Figure B-2: Launching the Recovery Tool

Step 3: The recovery tool setup menu is shown as below.

```
C:\WINDOWS\system32\cmd.exe

1.Execute Ghost
2.Manual Recovery environment For Windows
3.Manual Recovery environment For Linux
4.Auto Recovery environment For Windows
5.Exit
6.Command Prompt
Type the number to print text.
```

Figure B-3: Recovery Tool Setup Menu

Step 4: Press <6> then <Enter>.

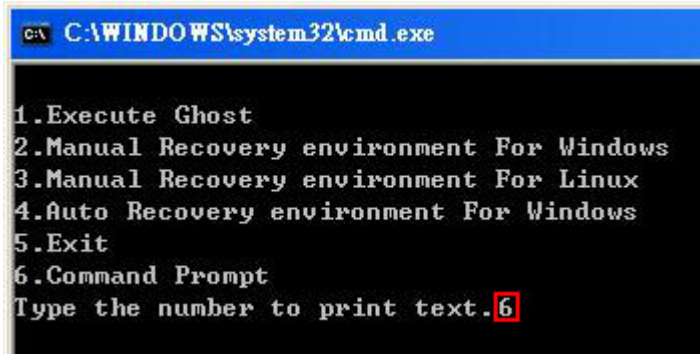

```
C:\WINDOWS\system32\cmd.exe

1.Execute Ghost
2.Manual Recovery environment For Windows
3.Manual Recovery environment For Linux
4.Auto Recovery environment For Windows
5.Exit
6.Command Prompt
Type the number to print text. 6
```

Figure B-4: Command Mode

Step 5: The command prompt window appears. Type the following commands (marked in red) to create two partitions. One is for the OS installation; the other is for saving recovery files and images which will be an invisible partition. (Press <Enter> after entering each line below)

```
system32>diskpart
DISKPART>list vol
DISKPART>sel disk 0
DISKPART>create part pri size= ____
DISKPART>assign letter=N
DISKPART>create part pri size= ____
DISKPART>assign letter=F
DISKPART>exit
system32>format N: /fs:ntfs /q /y
system32>format F: /fs:ntfs /q /v:Recovery /y
system32>exit
```

SPCIE-C2060 PICMG 1.3 CPU Card

```

X:\I386\SYSTEM32\CMD.EXE
X:\I386\SYSTEM32>diskpart → Starts the Microsoft disk partitioning tool.

Microsoft DiskPart version 5.2.3790.1830
Copyright (C) 1999-2001 Microsoft Corporation.
On computer: MININT-JUC

DISKPART> list vol → Show partition information

   Volume ###  Ltr  Label          Fs          Type        Size         Status       Info
   -----  -  -  -  -  -  -  -  -  -
   Volume 0             X  CD_ROM        CDFS        DUD-ROM     405 MB      Healthy      Boot
   Volume 1             D                FAT32      Removeable  3854 MB     Healthy

DISKPART> sel disk 0 → Select a disk

Disk 0 is now the selected disk.

DISKPART> create part pri size=2000 → Create partition 1 and assign a size.
                                       This partition is for OS installation.
DiskPart succeeded in creating the specified partition.

DISKPART> assign letter=N → Assign partition 1 a code name (N).
DiskPart successfully assigned the drive letter or mount point.

DISKPART> create part pri size=1800 → Create partition 2 and assign a size.
                                       This partition is for recovery images.
DiskPart succeeded in creating the specified partition.

DISKPART> assign letter=F → Assign partition 2 a code name (F).
DiskPart successfully assigned the drive letter or mount point.

DISKPART> exit → Exit diskpart

X:\I386\SYSTEM32>format n: /fs:ntfs /q /y → Format partition 1 (N) as NTFS format.
The type of the file system is RAW.
The new file system is NTFS.
QuickFormatting 2000M
Creating file system structures.
Format complete.
 2048254 KB total disk space.
 2035620 KB are available.

X:\I386\SYSTEM32>format f: /fs:ntfs /q /v:Recovery /y → Formate partition 2 (F) as NTFS formate and
                                                         name it as "Recovery".
The type of the file system is RAW.
The new file system is NTFS.
QuickFormatting 1804M
Creating file system structures.
Format complete.
 1847474 KB total disk space.
 1835860 KB are available.

X:\I386\SYSTEM32>exit → Exit Windows PE

```

Figure B-5: Partition Creation Commands

**NOTE:**

Use the following commands to check if the partitions were created successfully.

```
X:\I386\SYSTEM32>diskpart
Microsoft DiskPart version 5.2.3790.1830
Copyright (C) 1999-2001 Microsoft Corporation.
On computer: MININT-JUC
DISKPART> sel disk 0
Disk 0 is now the selected disk.
DISKPART> list part
  Partition ###  Type              Size      Offset
-----
  Partition 1    Primary           2000 MB    32 KB
  Partition 2    Primary           1804 MB    2000 MB
DISKPART> exit
```

Step 6: Press any key to exit the recovery tool and automatically reboot the system.

Please continue to the following procedure: Build the Recovery Partition.

B.2.3 Install Operating System, Drivers and Applications

Install the operating system onto the unlabelled partition. The partition labeled "Recovery" is for use by the system recovery tool and should not be used for installing the operating system or any applications.

**NOTE:**

The operating system installation program may offer to reformat the chosen partition. DO NOT format the partition again. The partition has already been formatted and is ready for installing the new operating system.

To install the operating system, insert the operating system installation CD into the optical drive. Restart the computer and follow the installation instructions.

SPCIE-C2060 PICMG 1.3 CPU Card

B.2.4 Build-up Recovery Partition

- Step 1:** Put the recover CD in the optical drive.
- Step 2:** Start the system.
- Step 3:** **Boot the system from the recovery CD.** When prompted, press any key to boot from the recovery CD. It will take a while to launch the recovery tool. Please be patient!

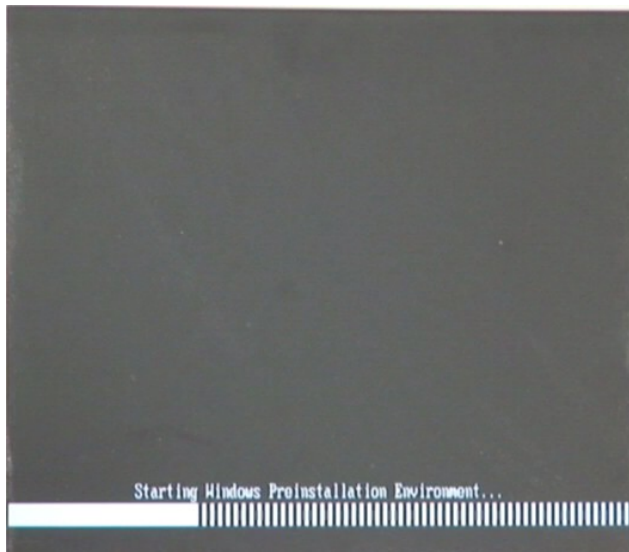

Figure B-6: Launching the Recovery Tool

- Step 4:** When the recovery tool setup menu appears, press <2> then <Enter>.

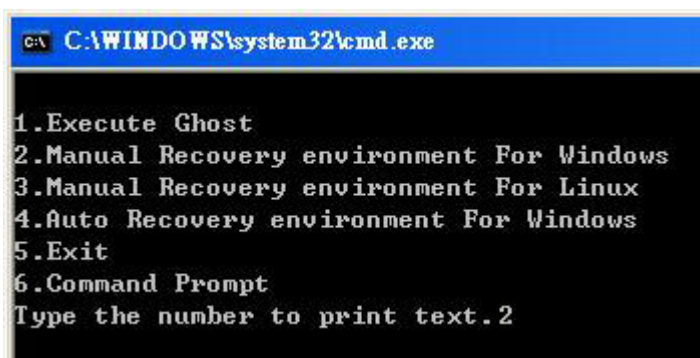

Figure B-7: Manual Recovery Environment for Windows

Step 5: The Symantec Ghost window appears and starts configuring the system to build a recovery partition. In this process the partition created for recovery files in **Section B.2.2** is hidden and the recovery tool is saved in this partition.

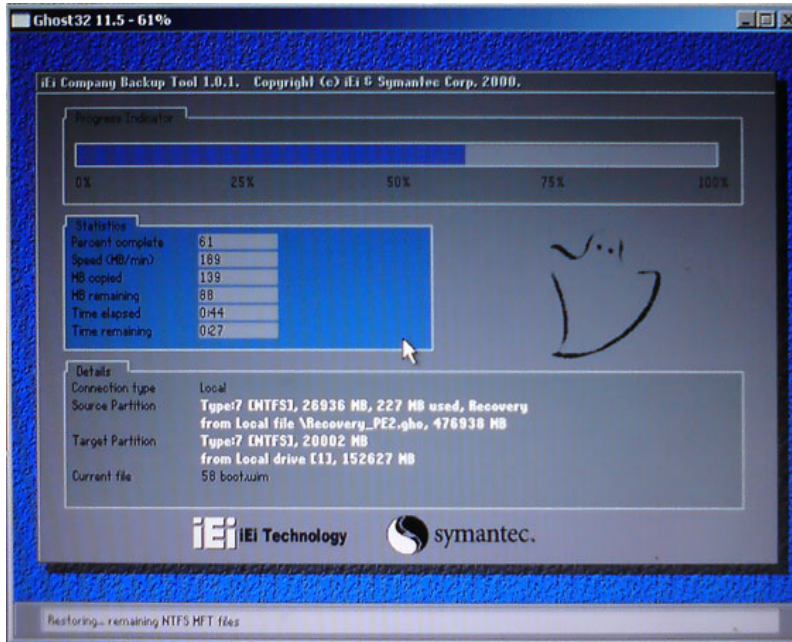

Figure B-8: Building the Recovery Partition

Step 6: After completing the system configuration, press any key in the following window to reboot the system.

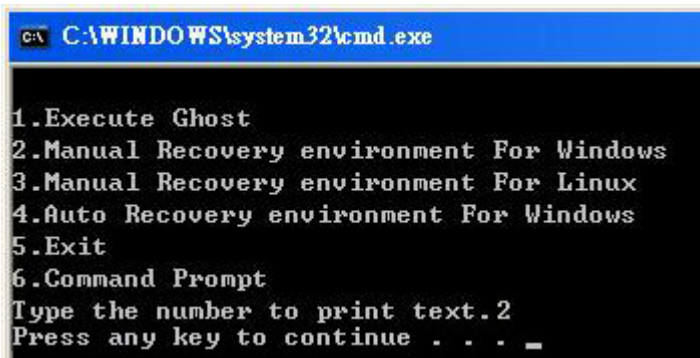

Figure B-9: Press Any Key to Continue

Step 7: Eject the recovery CD.

SPCIE-C2060 PICMG 1.3 CPU Card

B.2.5 Create Factory Default Image

**NOTE:**

Before creating the factory default image, please configure the system to a factory default environment, including driver and application installations.

To create a factory default image, please follow the steps below.

Step 1: Turn on the system. When the following screen displays (**Figure B-10**), press the <F3> key to access the recovery tool. The message will display for 10 seconds, please press F3 before the system boots into the operating system.

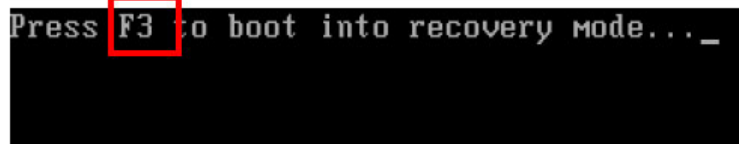

```
Press F3 to boot into recovery mode... _
```

Figure B-10: Press F3 to Boot into Recovery Mode

Step 2: The recovery tool menu appears. Type <4> and press <Enter>. (**Figure B-11**)

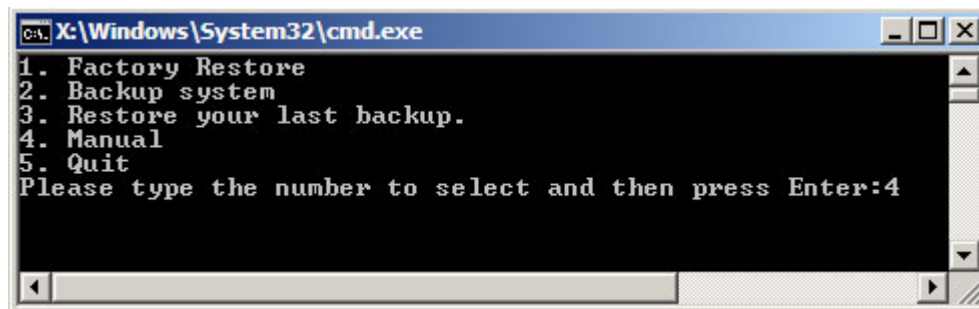

Figure B-11: Recovery Tool Menu

Step 3: The About Symantec Ghost window appears. Click **OK** button to continue.

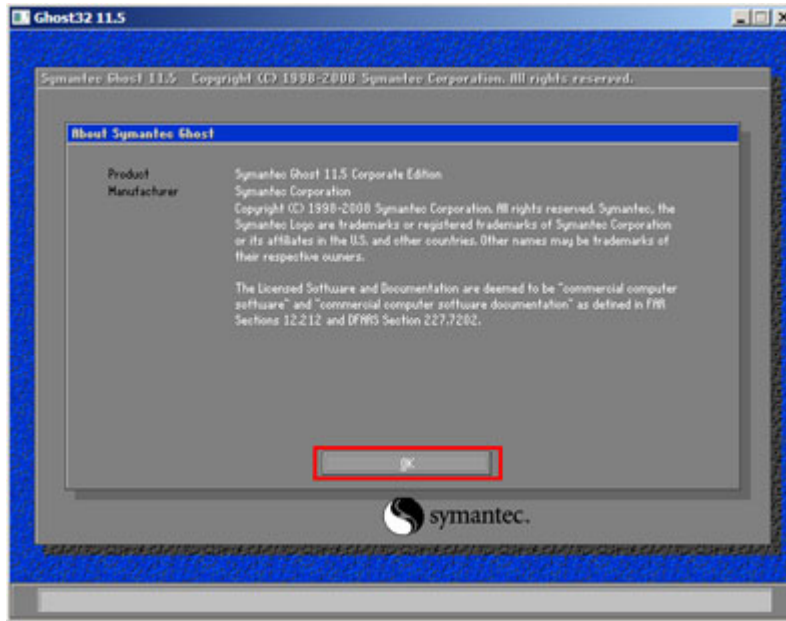

Figure B-12: About Symantec Ghost Window

Step 4: Use mouse to navigate to the option shown below (Figure B-13).

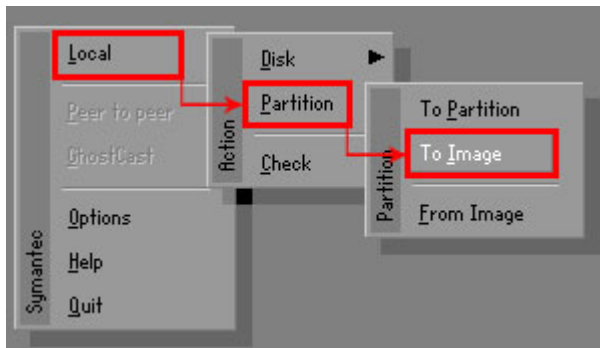

Figure B-13: Symantec Ghost Path

Step 5: Select the local source drive (Drive 1) as shown in Figure B-14. Then click OK.

SPCIE-C2060 PICMG 1.3 CPU Card

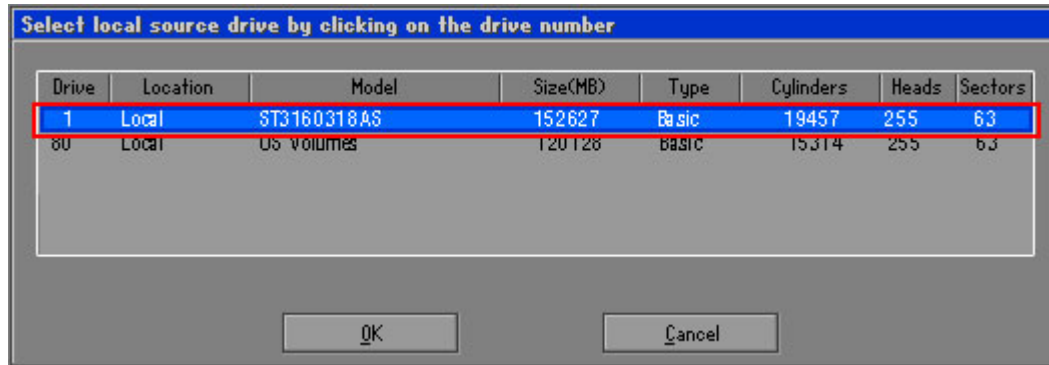

Figure B-14: Select a Local Source Drive

Step 6: Select a source partition (Part 1) from basic drive as shown in **Figure B-15**. Then click OK.

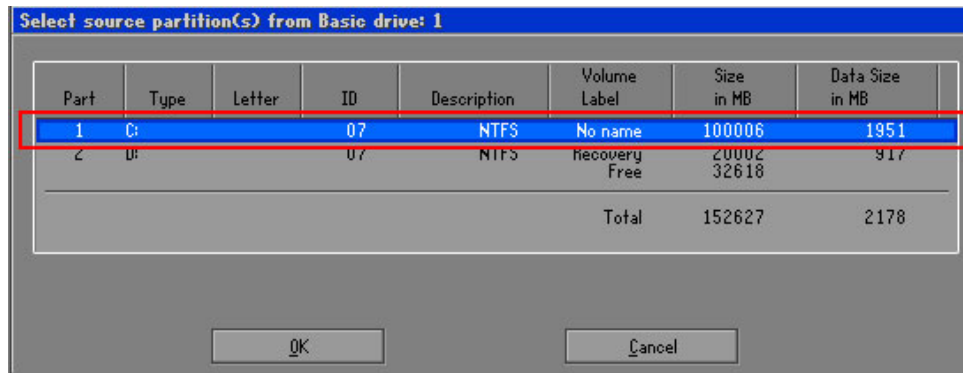

Figure B-15: Select a Source Partition from Basic Drive

Step 7: Select **1.2: [Recovery] NTFS drive** and enter a file name called **iei** (**Figure B-16**). Click **Save**. The factory default image will then be saved in the selected recovery drive and named **IEI.GHO**.



WARNING:

The file name of the factory default image must be **iei.GHO**.

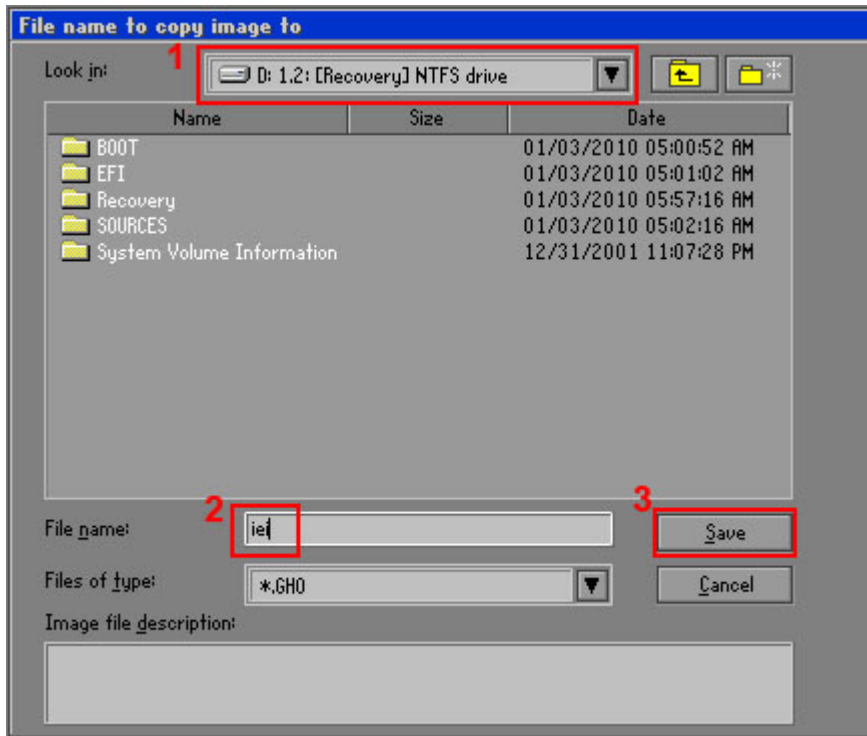

Figure B-16: File Name to Copy Image to

Step 8: When the Compress Image screen in **Figure B-17** prompts, click **High** to make the image file smaller.

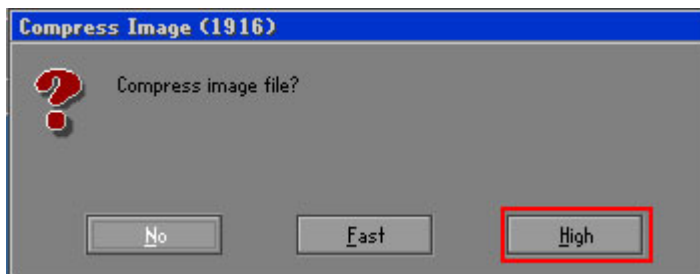

Figure B-17: Compress Image

SPCIE-C2060 PICMG 1.3 CPU Card

Step 9: The Proceed with partition image creation window appears, click **Yes** to continue.

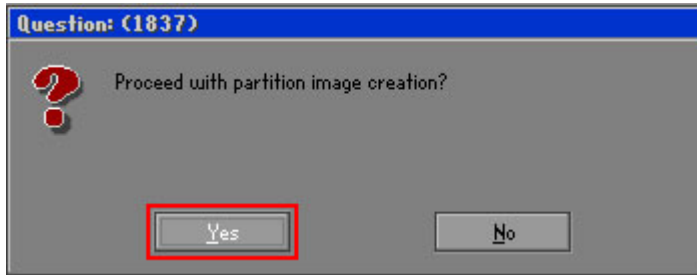

Figure B-18: Image Creation Confirmation

Step 10: The Symantec Ghost starts to create the factory default image (**Figure B-19**).

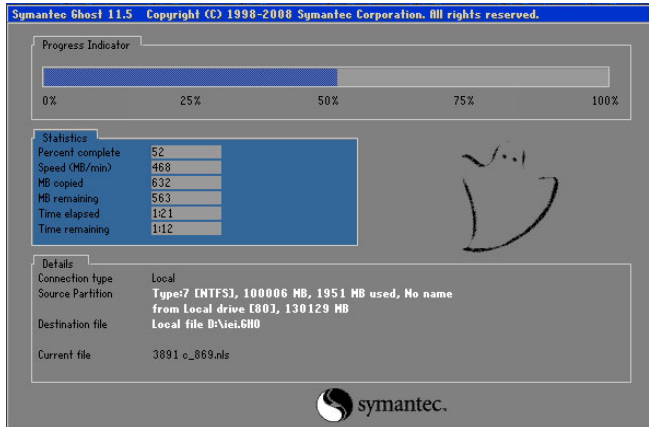

Figure B-19: Image Creation Complete

Step 11: When the image creation completes, a screen prompts as shown in **Figure B-20**. Click **Continue** and close the Ghost window to exit the program.



Figure B-20: Image Creation Complete

Step 12: The recovery tool main menu window is shown as below. Press any key to reboot the system.

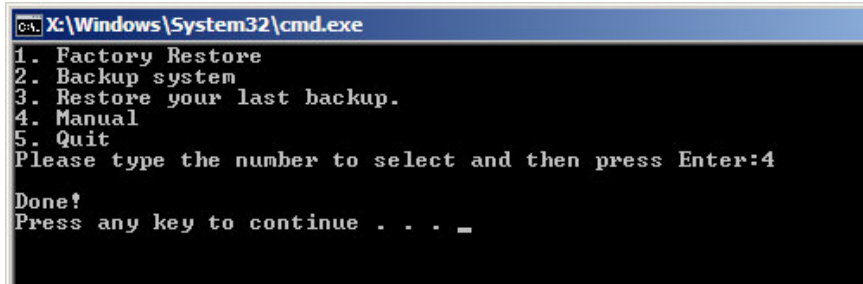

```
C:\Windows\System32\cmd.exe
1. Factory Restore
2. Backup system
3. Restore your last backup.
4. Manual
5. Quit
Please type the number to select and then press Enter:4
Done!
Press any key to continue . . . _
```

Figure B-21: Press Any Key to Continue

B.3 Auto Recovery Setup Procedure

The auto recovery function allows a system to automatically restore from the factory default image after encountering a Blue Screen of Death (BSoD) or a hang for around 10 minutes. To use the auto recovery function, follow the steps described in the following sections.



CAUTION:

The auto recovery function can only run on a Microsoft Windows system with the following OS versions:

- Windows 2000
- Windows XP
- Windows Vista
- Windows 7
- Windows XP Embedded
- Windows Embedded Standard 7



CAUTION:

The setup procedure may include a step to create a factory default image. It is suggested to configure the system to a factory default environment before the configuration, including driver and application installations.

SPCIE-C2060 PICMG 1.3 CPU Card

- Step 1:** Follow the steps described in **Section B.2.1 ~ Section B.2.3** to setup BIOS, create partitions and install operating system.
- Step 2:** Install the auto recovery utility into the system by double clicking the **Utility/AUTORECOVERY-SETUP.exe** in the One Key Recovery CD. This utility **MUST** be installed in the system, otherwise, the system will automatically restore from the factory default image every ten (10) minutes.



Figure B-22: Auto Recovery Utility

- Step 3:** **Disable the automatically restart function before creating the factory default image.** Go to: My Computer → Properties → Advanced. Click the Settings button of Startup and Recovery. Deselect "Automatically restart". Click OK to save the settings and exit. (See Figure B-23)

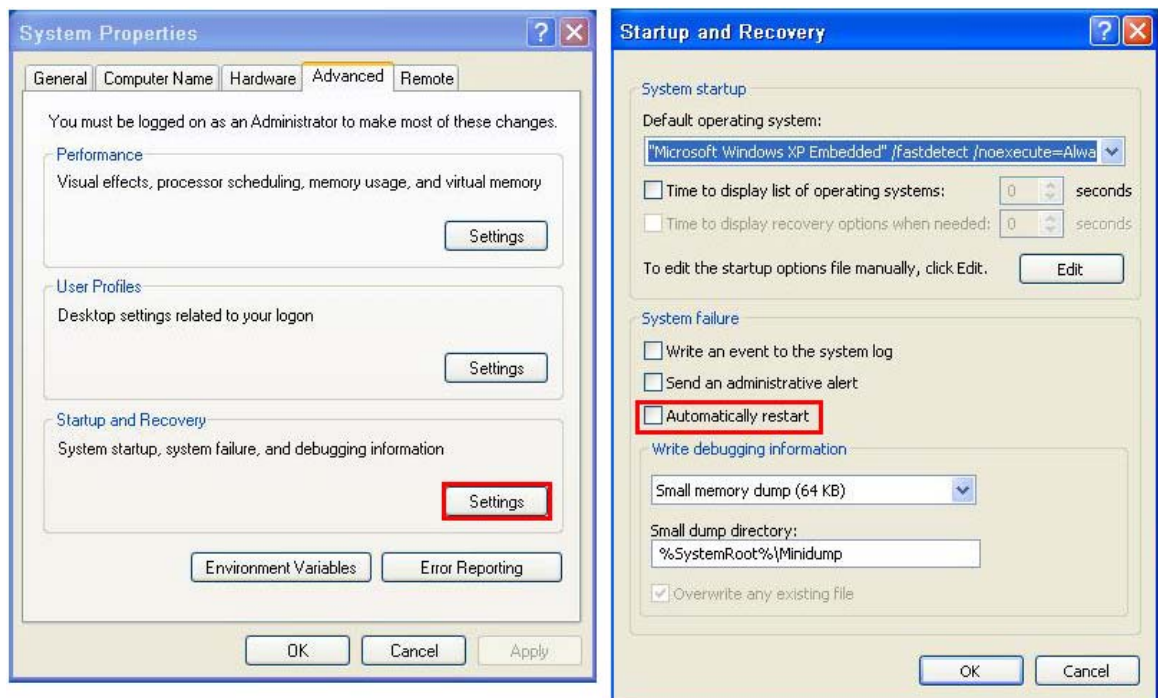

Figure B-23: Disable Automatically Restart

Step 4: Reboot the system from the recovery CD. When prompted, press any key to boot from the recovery CD. It will take a while to launch the recovery tool. Please be patient!

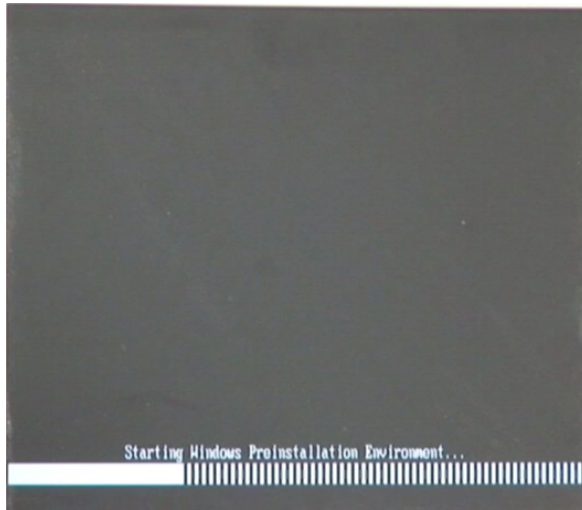

Figure B-24: Launching the Recovery Tool

Step 5: When the recovery tool setup menu appears, press <4> then <Enter>.

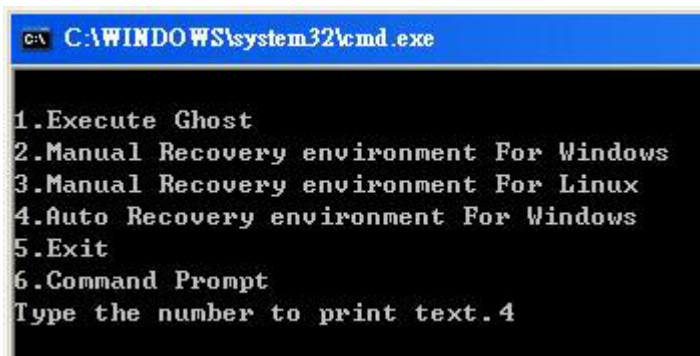

Figure B-25: Auto Recovery Environment for Windows

Step 6: The Symantec Ghost window appears and starts configuring the system to build an auto recovery partition. In this process the partition created for recovery files in **Section B.2.2** is hidden and the auto recovery tool is saved in this partition.

SPCIE-C2060 PICMG 1.3 CPU Card

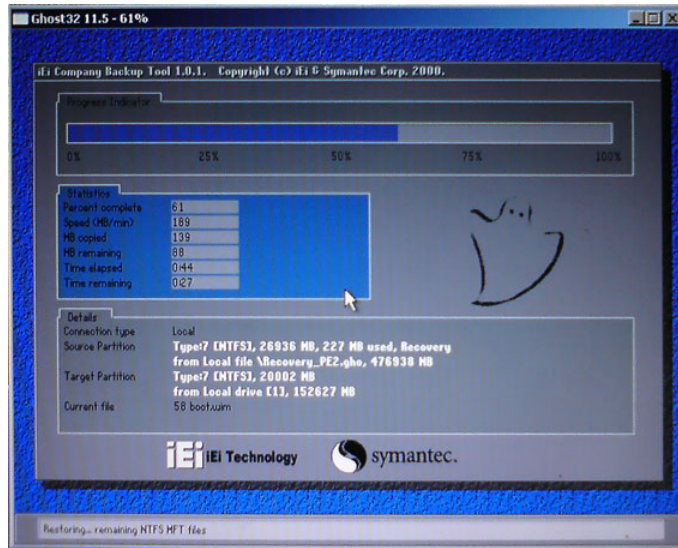

Figure B-26: Building the Auto Recovery Partition

Step 7: After completing the system configuration, the following message prompts to confirm whether to create a factory default image. Type **Y** to have the system create a factory default image automatically. Type **N** within 6 seconds to skip this process (The default option is YES). It is suggested to choose YES for this option.



Figure B-27: Factory Default Image Confirmation

Step 8: The Symantec Ghost starts to create the factory default image (**Figure B-28**).

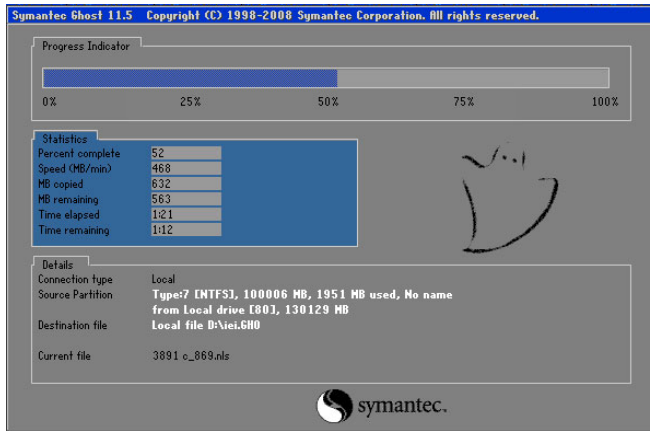

Figure B-28: Image Creation Complete

Step 9: After completing the system configuration, press any key in the following window to restart the system.

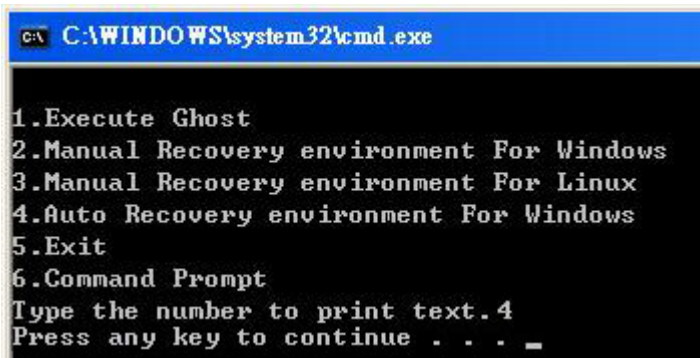

Figure B-29: Press any key to continue

Step 10: Eject the One Key Recovery CD and restart the system.

Step 11: Press the <DELETE> key as soon as the system is turned on to enter the BIOS.

Step 12: Enable the Auto Recovery Function option (**Advanced** → **iEi Feature** → **Auto Recovery Function**).

SPCIE-C2060 PICMG 1.3 CPU Card

```

BIOS SETUP UTILITY
Main  Advanced  PCIPNP  Boot  Security  Chipset  Exit
-----
iEi Feature
-----
Auto Recovery Function      [Enabled]
Recover from PXE           [Disabled]

                                  ←→  Select Screen
                                  ↑↓  Select Item
                                  Enter Go to SubScreen
                                  F1   General Help
                                  F10  Save and Exit
                                  ESC  Exit

v02.61 ©Copyright 1985-2006, American Megatrends, Inc.

```

BIOS Menu 31: IEI Feature

Step 13: Save changes and restart the system. If the system encounters a Blue Screen of Death (BSoD) or a hang for around 10 minutes, it will automatically restore from the factory default image.

B.4 Setup Procedure for Linux

The initial setup procedures for a Linux system are mostly the same with the procedure for Microsoft Windows. Please follow the steps below to setup the recovery tool for Linux OS.

Step 1: Hardware and BIOS setup. Refer to **Section B.2.1**.

Step 2: Install Linux operating system. Make sure to install GRUB (v0.97 or earlier) MBR type and Ext3 partition type. Leave enough space on the hard drive to create the recover partition later.

**NOTE:**

If the Linux OS is not installed with GRUB (v0.97 or earlier) and Ext3, the Symantec Ghost may not function properly.

While installing Linux OS, please create two partitions:

- Partition 1: /
- Partition 2: SWAP

**NOTE:**

Please reserve enough space for partition 3 for saving recovery images.

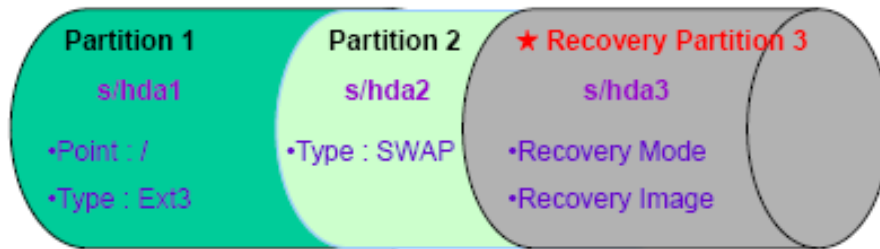

Figure B-30: Partitions for Linux

Step 3: Create a recovery partition. Insert the recovery CD into the optical disk drive.

Follow **Step 1 ~ Step 3** described in **Section B.2.2**. Then type the following commands (marked in red) to create a partition for recovery images.

```
system32>diskpart
DISKPART>list vol
DISKPART>sel disk 0
DISKPART>create part pri size= ____
DISKPART>assign letter=N
DISKPART>exit
system32>format N: /fs:ntfs /q /v:Recovery /y
system32>exit
```

Step 4: Build-up recovery partition. Press any key to boot from the recovery CD. It will take a while to launch the recovery tool. Please be patient. When the recovery tool setup menu appears, type <3> and press <Enter> (**Figure B-31**). The Symantec Ghost window appears and starts configuring the system to build-up a

SPCIE-C2060 PICMG 1.3 CPU Card

recovery partition. After completing the system configuration, press any key to reboot the system. Eject the recovery CD.

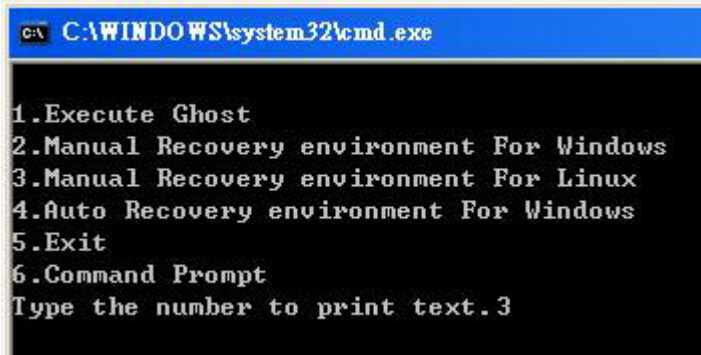

```
C:\WINDOWS\system32\cmd.exe

1.Execute Ghost
2.Manual Recovery environment For Windows
3.Manual Recovery environment For Linux
4.Auto Recovery environment For Windows
5.Exit
6.Command Prompt
Type the number to print text.3
```

Figure B-31: System Configuration for Linux

Step 5: Access the recovery tool main menu by modifying the “menu.lst”. To first access the recovery tool main menu, the menu.lst must be modified. In Linux, enter Administrator (root). When prompt appears, type:

```
cd /boot/grub
```

```
vi menu.lst
```

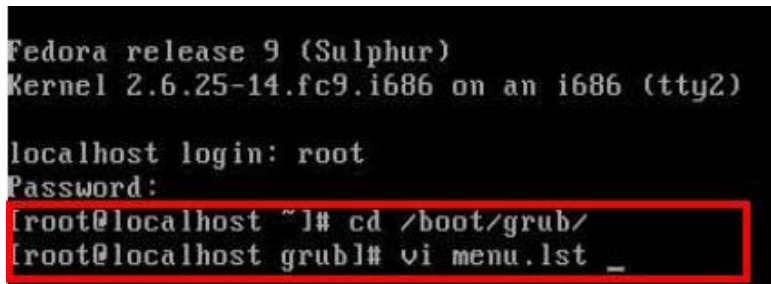

```
Fedora release 9 (Sulphur)
Kernel 2.6.25-14.fc9.i686 on an i686 (tty2)

localhost login: root
Password:
[root@localhost ~]# cd /boot/grub/
[root@localhost grub]# vi menu.lst _
```

Figure B-32: Access menu.lst in Linux (Text Mode)

Step 6: Modify the menu.lst as shown below.

```
#boot=/dev/sda
default=0
timeout=10 ← Modify timeout=10
splashimage=(hd0,0)/grub/splash.xpm.gz
hiddenmenu
title Fedora (2.6.25-14.fc9.i686)
    root (hd0,0)
    kernel /vmlinuz-2.6.25-14.fc9.i686 ro root=UUID=10f1acd
ac38b5c78910 rhgb quiet
    initrd /initrd-2.6.25-14.fc9.i686.img

title Recovery Partition
root (hd0,2)
makeactive ← Type command
chainloader +1
```

- Type command:
title Recovery Partition
root (hd0,2)
makeactive
chainloader +1

Step 7: The recovery tool menu appears. (Figure B-33)

```
1. Factory Restore
2. Backup system
3. Restore your last backup.
4. Manual
5. Quit
Please type the number to select and then press Enter:
```

Figure B-33: Recovery Tool Menu

Step 8: Create a factory default image. Follow **Step 2 ~ Step 12** described in **Section B.2.5** to create a factory default image.

B.5 Recovery Tool Functions

After completing the initial setup procedures as described above, users can access the recovery tool by pressing <F3> while booting up the system. However, if the setup procedure in Section B.3 has been completed and the auto recovery function is enabled, the system will automatically restore from the factory default image without pressing the F3 key. The recovery tool main menu is shown below.

SPCIE-C2060 PICMG 1.3 CPU Card

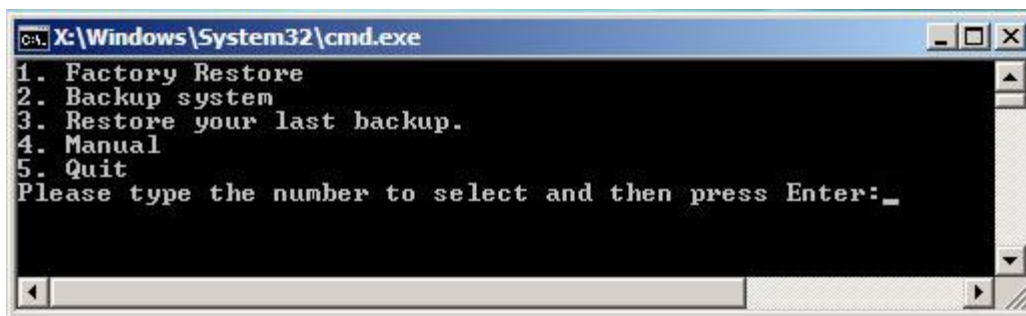

Figure B-34: Recovery Tool Main Menu

The recovery tool has several functions including:

1. **Factory Restore:** Restore the factory default image (iei.GHO) created in Section B.2.5.
2. **Backup system:** Create a system backup image (iei_user.GHO) which will be saved in the hidden partition.
3. **Restore your last backup:** Restore the last system backup image
4. **Manual:** Enter the Symantec Ghost window to configure manually.
5. **Quit:** Exit the recovery tool and restart the system.

**WARNING:**

Please do not turn off the system power during the process of system recovery or backup.

**WARNING:**

All data in the system will be deleted during the system recovery. Please backup the system files before restoring the system (either Factory Restore or Restore Backup).

B.5.1 Factory Restore

To restore the factory default image, please follow the steps below.

Step 1: Type <1> and press <Enter> in the main menu.

Step 2: The Symantec Ghost window appears and starts to restore the factory default. A factory default image called **iei.GHO** is created in the hidden Recovery partition.

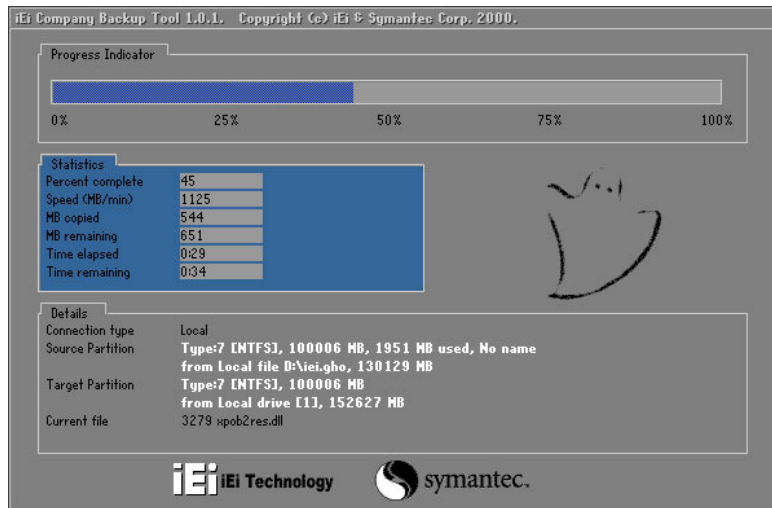

Figure B-35: Restore Factory Default

Step 3: The screen is shown in **Figure B-36** appears when completed. Press any key to reboot the system.

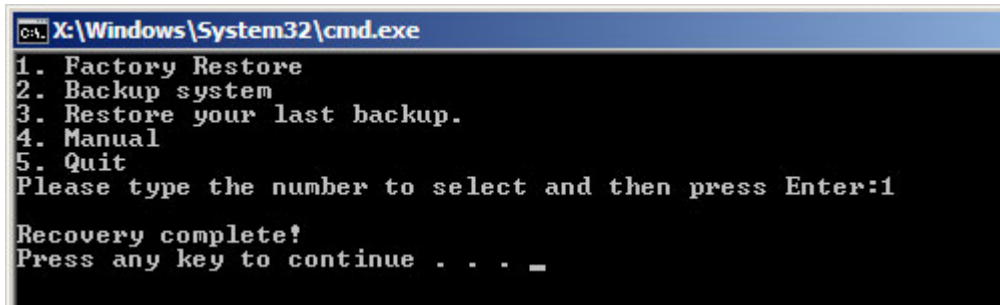

Figure B-36: Recovery Complete Window

SPCIE-C2060 PICMG 1.3 CPU Card

B.5.2 Backup System

To backup the system, please follow the steps below.

Step 1: Type <2> and press <Enter> in the main menu.

Step 2: The Symantec Ghost window appears and starts to backup the system. A backup image called `iei_user.GHO` is created in the hidden Recovery partition.

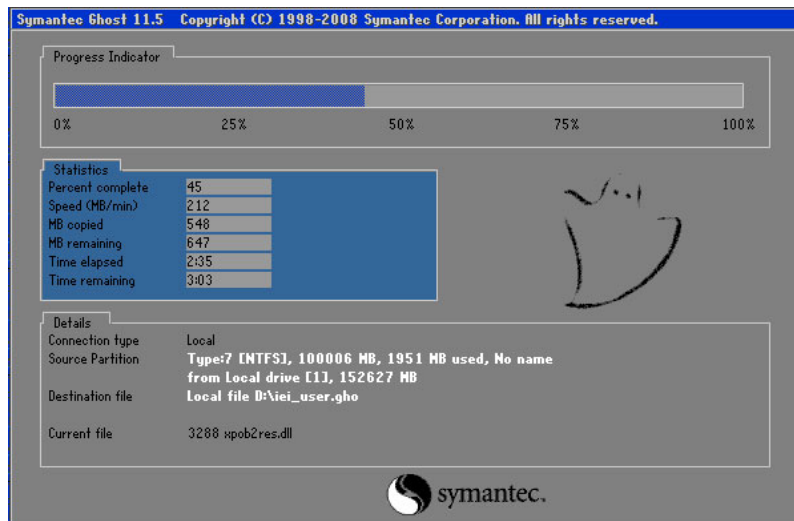

Figure B-37: Backup System

Step 3: The screen is shown in **Figure B-38** appears when system backup is complete. Press any key to reboot the system.

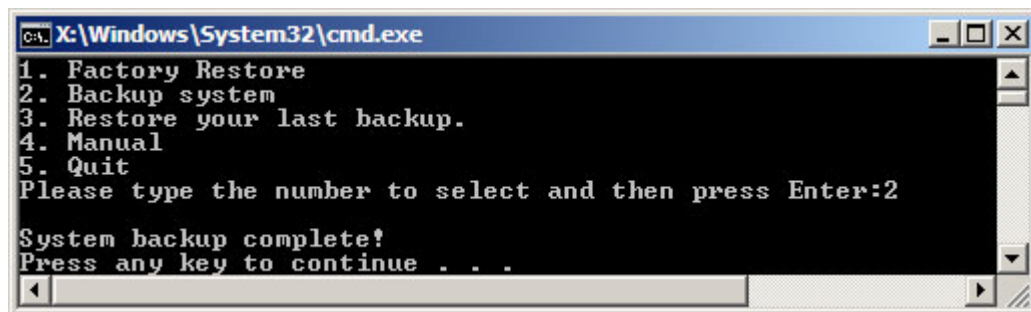

Figure B-38: System Backup Complete Window

B.5.3 Restore Your Last Backup

To restore the last system backup, please follow the steps below.

Step 1: Type <3> and press <Enter> in the main menu.

Step 2: The Symantec Ghost window appears and starts to restore the last backup image (iei_user.GHO).

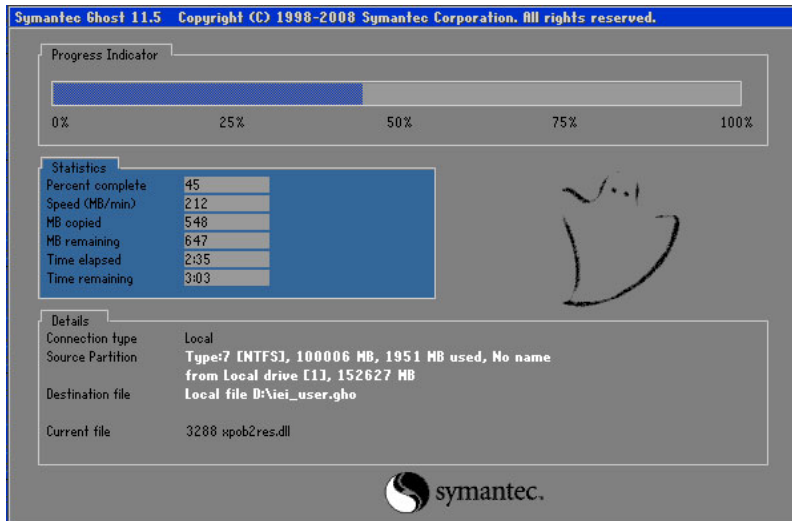

Figure B-39: Restore Backup

Step 3: The screen shown in **Figure B-40** appears when backup recovery is complete. Press any key to reboot the system.

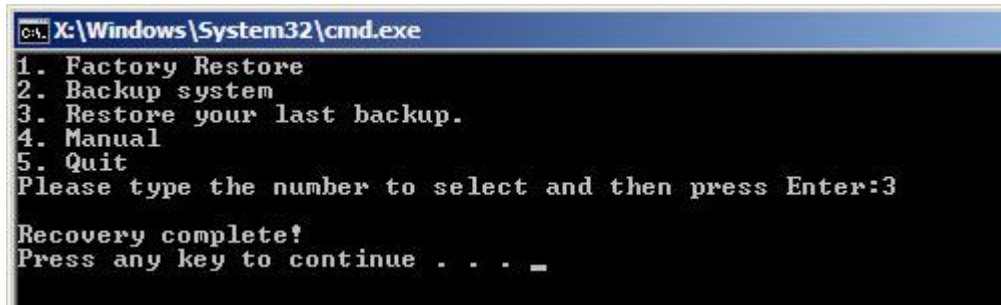

Figure B-40: Restore System Backup Complete Window

SPCIE-C2060 PICMG 1.3 CPU Card

B.5.4 Manual

To restore the last system backup, please follow the steps below.

Step 1: Type <4> and press <Enter> in the main menu.

Step 2: The Symantec Ghost window appears. Use the Ghost program to backup or recover the system manually.

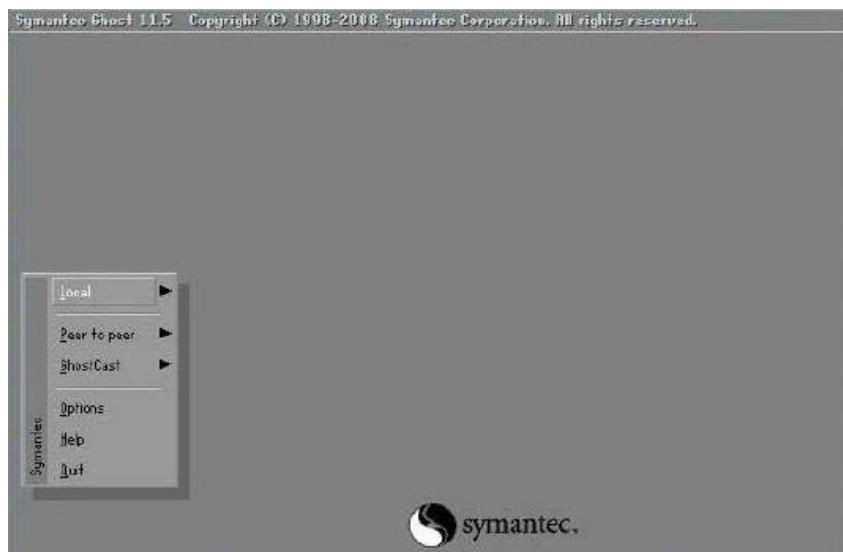
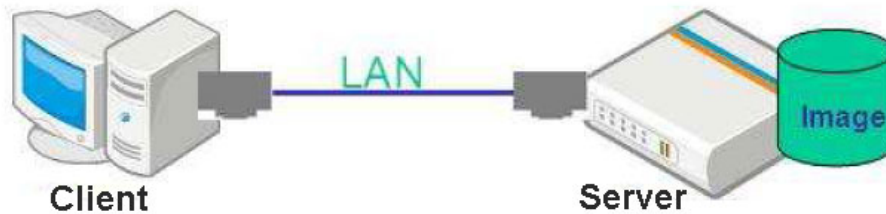

Figure B-41: Symantec Ghost Window

Step 3: When backup or recovery is completed, press any key to reboot the system.

B.6 Restore Systems from a Linux Server through LAN

The One Key Recovery allows a client system to automatically restore to a factory default image saved in a Linux system (the server) through LAN connectivity after encountering a Blue Screen of Death (BSoD) or a hang for around 10 minutes. To be able to use this function, the client system and the Linux system MUST reside in the same domain.



CAUTION:

The supported client OS includes:

- Windows 2000
- Windows XP
- Windows Vista
- Windows 7
- Windows XP Embedded
- Windows Embedded Standard 7

Prior to restoring client systems from a Linux server, a few setup procedures are required.

Step 1: Configure DHCP server settings

Step 2: Configure TFTP settings

Step 3: Configure One Key Recovery server settings

Step 4: Start DHCP, TFTP and HTTP

Step 5: Create a shared directory

Step 6: Setup a client system for auto recovery

The detailed descriptions are described in the following sections. In this document, two types of Linux OS are used as examples to explain the configuration process – CentOS 5.5 (Kernel 2.6.18) and Debian 5.0.7 (Kernel 2.6.26).

SPCIE-C2060 PICMG 1.3 CPU Card

B.6.1 Configure DHCP Server Settings

Step 1: Install the DHCP

`#yum install dhcp` (CentOS, commands marked in red)

`#apt-get install dhcp3-server` (Debian, commands marked in blue)

Step 2: Confirm the operating system default settings: dhcpd.conf.

CentOS

Use the following command to show the DHCP server sample location:

`#vi /etc/dhcpd.conf`

The DHCP server sample location is shown as below:

```
# DHCP Server Configuration file.
# see /usr/share/doc/dhcp*/dhcpd.conf.sample
```

Use the following command to copy the DHCP server sample to etc/dhcpd.conf:

`#cp /usr/share/doc/dhcp-3.0.5/dhcpd.conf.sample /etc/dhcpd.conf`

`#vi /etc/dhcpd.conf`

```
ddns-update-style interim;
ignore client-updates;

subnet 192.168.0.0 netmask 255.255.255.0 {
# --- default gateway
    option routers                192.168.0.2;
    option subnet-mask            255.255.255.0;

    option nis-domain              "domain.org";
    option domain-name            "domain.org";
    option domain-name-servers    192.168.0.1;
    next-server 192.168.0.6;
    filename "pxelinux.0";
    option time-offset             -18000; # Eastern Standard Time
    option ntp-servers            192.168.1.1;
    option ntp-servers            192.168.1.1;
}
```

Debian

`#vi /etc/dhcpd.conf`

Edit “/etc/dhcpd.conf” for your environment. For example, add

`next-server PXE server IP address;`

filename "pxelinux.0";

```
ddns-update-style interim;
ignore client-updates;

subnet 192.168.0.0 netmask 255.255.255.0 {
# --- default gateway
    option routers                192.168.0.2;
    option subnet-mask           255.255.255.0;

    option nis-domain            "domain.org";
    option domain-name           "domain.org";
    option domain-name-servers   192.168.0.1;
    next-server 192.168.0.6;
    filename "pxelinux.0";
    option time-offset           -18000; # Eastern Standard Time
    option ntp-servers           192.168.1.1;
}
```

B.6.2 Configure TFTP Settings

Step 1: Install the tftp, httpd and syslinux.

```
#yum install tftp-server httpd syslinux (CentOS)
```

```
#apt-get install tftpd-hpa xinetd syslinux (Debian)
```

Step 2: Enable the TFTP server by editing the "/etc/xinetd.d/tftp" file and make it use the remap file. The "-vvv" is optional but it could definitely help on getting more information while running the remap file. For example:

CentOS

```
#vi /etc/xinetd.d/tftp
```

Modify:

```
disable = no
```

```
server_args = -s /tftpboot -m /tftpboot/tftpd.remap -vvv_
```

```
socket_type      = dgram
protocol        = udp
wait            = yes
user            = root
server          = /usr/sbin/in.tftpd
server_args     = -s /tftpboot -m /tftpboot/tftpd.remap -vvv
disable         = no
per_source      = 11
cps             = 100 2
flags           = IPv4
```

SPCIE-C2060 PICMG 1.3 CPU Card

Debian

Replace the TFTP settings from “inetd” to “xinetd” and annotate the “inetd” by adding “#”.

`#vi /etc/inetd.conf`

Modify: `#tftp dgram udp wait root /usr/sbin.....` (as shown below)

```
#:BOOT: TFTP service is provided primarily for booting. Most sites
#      run this only on machines acting as "boot servers."
#tftp  dgram  udp   wait  root  /usr/sbin/in.tftpd /usr/sbin/in.tftpd -s
/var/lib/tftpboot
```

`#vi /etc/xinetd.d/tftp`

```
socket_type      = dgram
protocol        = udp
wait            = yes
user            = root
server          = /usr/sbin/in.tftpd
server_args     = -s /tftpboot -n /tftpboot/tftpd.remap -vvv
disable         = no
per_source      = 11
cps             = 100 2
flags           = IPv4
```

B.6.3 Configure One Key Recovery Server Settings

Step 1: Copy the **Utility/RECOVERYR10.TAR.BZ2** package from the One Key Recovery CD to the system (server side).



Step 2: Extract the recovery package to /.

```
#cp RecoveryR10.tar.bz2 /
#cd /
#tar -xvzf RecoveryR10.tar.bz2
```

Step 3: Copy “pxelinux.0” from “syslinux” and install to “tftpboot”.

```
#cp /usr/lib/syslinux/pxelinux.0 /tftpboot/
```

B.6.4 Start the DHCP, TFTP and HTTP

Start the DHCP, TFTP and HTTP. For example:

CentOS

```
#service xinetd restart
```

```
#service httpd restart
```

```
#service dhcpd restart
```

Debian

```
#/etc/init.d/xinetd reload
```

```
#/etc/init.d/xinetd restart
```

```
#/etc/init.d/dhcp3-server restart
```

B.6.5 Create Shared Directory

Step 1: Install the samba.

```
#yum install samba
```

Step 2: Create a shared directory for the factory default image.

```
#mkdir /share
```

```
#cd /share
```

```
#mkdir /image
```

```
#cp iei.gho /image
```



WARNING:

The file name of the factory default image must be **iei.gho**.

Step 3: Confirm the operating system default settings: smb.conf.

```
#vi /etc/samba/smb.conf
```

SPCIE-C2060 PICMG 1.3 CPU Card

Modify:

[image]

comment = One Key Recovery

path = /share/image

browseable = yes

writable = yes

public = yes

create mask = 0644

directory mask = 0755

Step 4: Edit “/etc/samba/smb.conf” for your environment. For example:

```
# "security = user" is always a good idea. This will require a Unix account
# in this server for every user accessing the server. See
# /usr/share/doc/samba-doc/htmldocs/Samba3-HOWTO/ServerType.html
# in the samba-doc package for details.
security = share
```

```
[image]
comment = One Key Recovery
path = /share/image
browseable = yes
writable = yes
public = yes
create mask = 0644
directory mask = 0755
```

Step 5: Modify the hostname

```
#vi /etc/hostname
```

Modify: RecoveryServer

```
RecoveryServer
```

B.6.6 Setup a Client System for Auto Recovery

Step 1: Disable the automatically restart function before creating the factory default image. Go to: My Computer → Properties → Advanced. Click the Settings button of Startup and Recovery. Deselect “Automatically restart”. Click OK to save the settings and exit. (See Figure B-23)

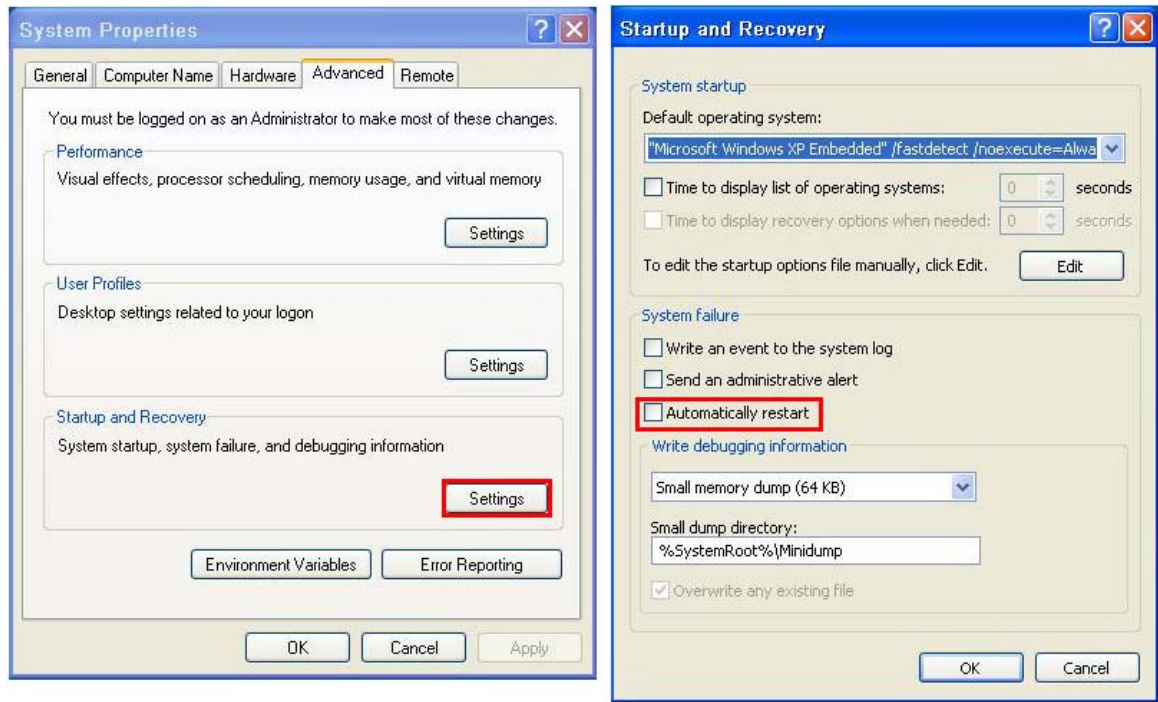

Figure B-42: Disable Automatically Restart

Step 2: Configure the following BIOS options of the client system.

Advanced → iEi Feature → Auto Recovery Function → **Enabled**

Advanced → iEi Feature → Recover from PXE → **Enabled**

Boot → Launch PXE OpROM → **Enabled**

Step 3: Continue to configure the **Boot Option Priorities** BIOS option of the client system:

Boot Option #1 → remain the default setting to boot from the original OS.

Boot Option #2 → select the boot from LAN option.

Step 4: Save changes and exit BIOS menu.

Exit → **Save Changes and Exit**

Step 5: Install the auto recovery utility into the system by double clicking the

Utility/AUTORECOVERY-SETUP.exe in the One Key Recovery CD. This utility

SPCIE-C2060 PICMG 1.3 CPU Card

MUST be installed in the system, otherwise, the system will automatically restore from the factory default image every ten (10) minutes.



Step 6: Restart the client system from LAN. If the system encounters a Blue Screen of Death (BSoD) or a hang for around 10 minutes, it will automatically restore from the factory default image. The following screens will show when the system starts auto recovering.

```
Realtek PCIe GBE Family Controller Series v2.35 (06/14/10)
CLIENT MAC ADDR: 00 18 7D 13 E6 89  GUID: 00020003-0004-0005-0006-0007000000
DHCP . ./
```

```
My IP address seems to be C0A80009 192.168.0.9
ip=192.168.0.9:192.168.0.8:192.168.0.2:255.255.255.0
TFTP prefix:
Trying to load: pxelinux.cfg/00020003-0004-0005-0006-000700000009
Trying to load: pxelinux.cfg/01-00-18-7d-13-e6-89
Trying to load: pxelinux.cfg/C0A80009
Trying to load: pxelinux.cfg/C0A8000
Trying to load: pxelinux.cfg/C0A800
Trying to load: pxelinux.cfg/C0A80
Trying to load: pxelinux.cfg/C0A8
Trying to load: pxelinux.cfg/C0A
Trying to load: pxelinux.cfg/C0
Trying to load: pxelinux.cfg/C
Trying to load: pxelinux.cfg/default
boot:
```

Windows is loading files...

```
IP: 192.168.0.8, File: \Boot\WinPE.wim
```

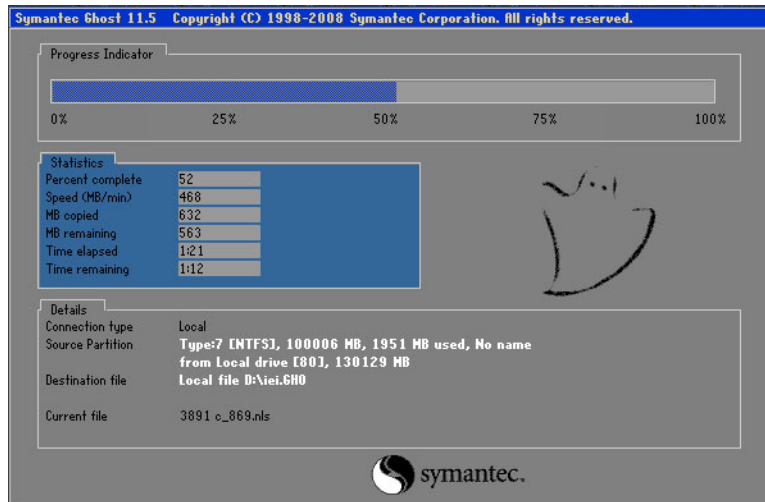
**NOTE:**

A firewall or a SELinux is not in use in the whole setup process described above. If there is a firewall or a SELinux protecting the system, modify the configuration information to accommodate them.

B.7 Other Information

B.7.1 Using AHCI Mode or ALi M5283 / VIA VT6421A Controller

When the system uses AHCI mode or some specific SATA controllers such as ALi M5283 or VIA VT6421A, the SATA RAID/AHCI driver must be installed before using one key recovery. Please follow the steps below to install the SATA RAID/AHCI driver.

- Step 1:** Copy the SATA RAID/AHCI driver to a floppy disk and insert the floppy disk into a USB floppy disk drive. The SATA RAID/AHCI driver must be especially designed for the on-board SATA controller.
- Step 2:** Connect the USB floppy disk drive to the system.
- Step 3:** Insert the One Key Recovery CD into the system and boot the system from the CD.
- Step 4:** When launching the recovery tool, press <F6>.

SPCIE-C2060 PICMG 1.3 CPU Card

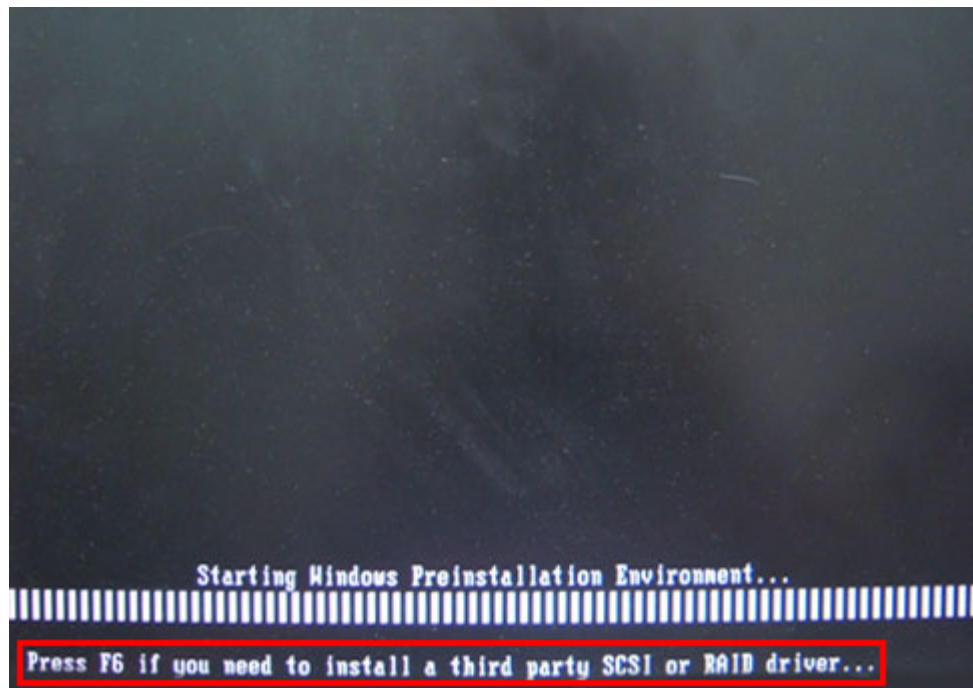

Step 5: When the following window appears, press <S> to select "Specify Additional Device".

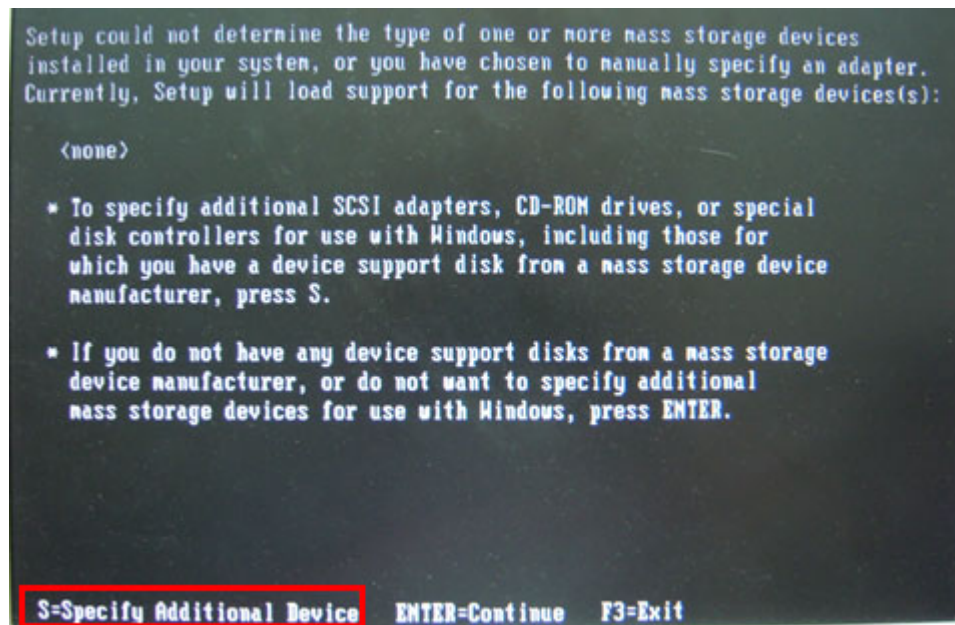

Step 6: In the following window, select a SATA controller mode used in the system. Then press <Enter>. The user can now start using the SATA HDD.

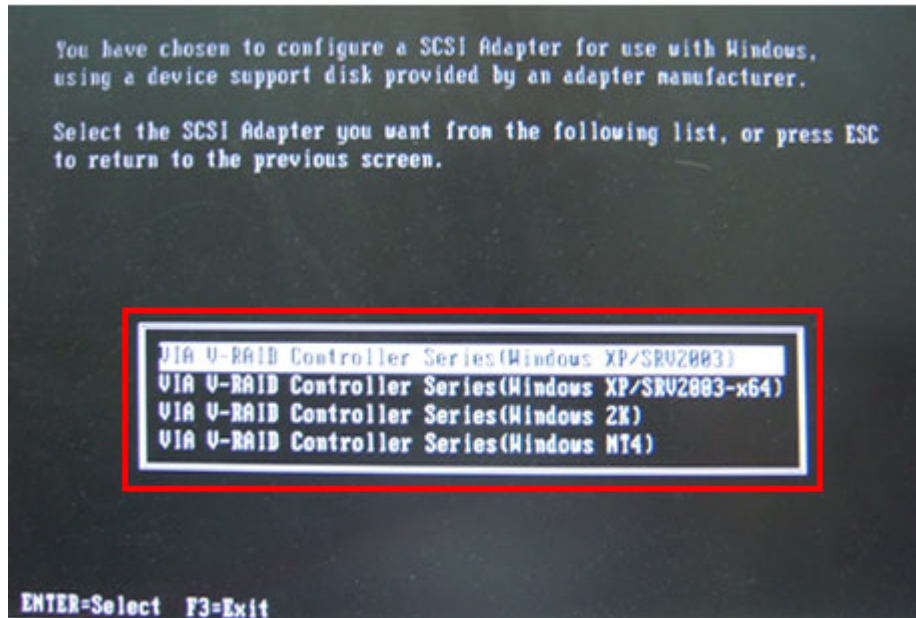

Step 7: After pressing <Enter>, the system will get into the recovery tool setup menu. Continue to follow the setup procedure from **Step 4** in **Section B.2.2 Create Partitions** to finish the whole setup process.

B.7.2 System Memory Requirement

To be able to access the recovery tool by pressing <F3> while booting up the system, please make sure to have enough system memory. The minimum memory requirement is listed below.

- **Using Award BIOS:** 128 MB system memory
- **Using AMI BIOS:** 512 MB system memory.

Appendix

C

Terminology

AC '97	Audio Codec 97 (AC'97) refers to a codec standard developed by Intel® in 1997.
ACPI	Advanced Configuration and Power Interface (ACPI) is an OS-directed configuration, power management, and thermal management interface.
AHCI	Advanced Host Controller Interface (AHCI) is a SATA Host controller register-level interface.
ATA	The Advanced Technology Attachment (ATA) interface connects storage devices including hard disks and CD-ROM drives to a computer.
ARMD	An ATAPI Removable Media Device (ARMD) is any ATAPI device that supports removable media, besides CD and DVD drives.
ASKIR	Amplitude Shift Keyed Infrared (ASKIR) is a form of modulation that represents a digital signal by varying the amplitude (“volume”) of the signal. A low amplitude signal represents a binary 0, while a high amplitude signal represents a binary 1.
BIOS	The Basic Input/Output System (BIOS) is firmware that is first run when the computer is turned on and can be configured by the end user
CODEC	The Compressor-Decompressor (CODEC) encodes and decodes digital audio data on the system.
CMOS	Complimentary metal-oxide-conductor is an integrated circuit used in chips like static RAM and microprocessors.
COM	COM refers to serial ports. Serial ports offer serial communication to expansion devices. The serial port on a personal computer is usually a male DB-9 connector.
DAC	The Digital-to-Analog Converter (DAC) converts digital signals to analog signals.
DDR	Double Data Rate refers to a data bus transferring data on both the rising and falling edges of the clock signal.
DMA	Direct Memory Access (DMA) enables some peripheral devices to bypass the system processor and communicate directly with the system memory.

SPCIE-C2060 PICMG 1.3 CPU Card

DIMM	Dual Inline Memory Modules are a type of RAM that offer a 64-bit data bus and have separate electrical contacts on each side of the module.
DIO	The digital inputs and digital outputs are general control signals that control the on/off circuit of external devices or TTL devices. Data can be read or written to the selected address to enable the DIO functions.
EHCI	The Enhanced Host Controller Interface (EHCI) specification is a register-level interface description for USB 2.0 Host Controllers.
EIDE	Enhanced IDE (EIDE) is a newer IDE interface standard that has data transfer rates between 4.0 MBps and 16.6 MBps.
EIST	Enhanced Intel® SpeedStep Technology (EIST) allows users to modify the power consumption levels and processor performance through application software. The application software changes the bus-to-core frequency ratio and the processor core voltage.
FSB	The Front Side Bus (FSB) is the bi-directional communication channel between the processor and the Northbridge chipset.
GbE	Gigabit Ethernet (GbE) is an Ethernet version that transfers data at 1.0 Gbps and complies with the IEEE 802.3-2005 standard.
GPIO	General purpose input
HDD	Hard disk drive (HDD) is a type of magnetic, non-volatile computer storage device that stores digitally encoded data.
ICH	The Input/Output Control Hub (ICH) is an Intel® Southbridge chipset.
IrDA	Infrared Data Association (IrDA) specify infrared data transmission protocols used to enable electronic devices to wirelessly communicate with each other.
L1 Cache	The Level 1 Cache (L1 Cache) is a small memory cache built into the system processor.
L2 Cache	The Level 2 Cache (L2 Cache) is an external processor memory cache.
LCD	Liquid crystal display (LCD) is a flat, low-power display device that consists of two polarizing plates with a liquid crystal panel in between.

LVDS	Low-voltage differential signaling (LVDS) is a dual-wire, high-speed differential electrical signaling system commonly used to connect LCD displays to a computer.
POST	The Power-on Self Test (POST) is the pre-boot actions the system performs when the system is turned-on.
RAM	Random Access Memory (RAM) is volatile memory that loses data when power is lost. RAM has very fast data transfer rates compared to other storage like hard drives.
SATA	Serial ATA (SATA) is a serial communications bus designed for data transfers between storage devices and the computer chipsets. The SATA bus has transfer speeds up to 1.5 Gbps and the SATA II bus has data transfer speeds of up to 3.0 Gbps.
S.M.A.R.T	Self Monitoring Analysis and Reporting Technology (S.M.A.R.T) refers to automatic status checking technology implemented on hard disk drives.
UART	Universal Asynchronous Receiver-transmitter (UART) is responsible for asynchronous communications on the system and manages the system's serial communication (COM) ports.
UHCI	The Universal Host Controller Interface (UHCI) specification is a register-level interface description for USB 1.1 Host Controllers.
USB	The Universal Serial Bus (USB) is an external bus standard for interfacing devices. USB 1.1 supports 12Mbps data transfer rates and USB 2.0 supports 480Mbps data transfer rates.
VGA	The Video Graphics Array (VGA) is a graphics display system developed by IBM.

Appendix

D

Digital I/O Interface

D.1 Introduction

The DIO connector on the SPCIE-C2060 Series is interfaced to GPIO ports on the Super I/O chipset. The DIO has both 4-bit digital inputs and 4-bit digital outputs. The digital inputs and digital outputs are generally control signals that control the on/off circuit of external devices or TTL devices. Data can be read or written to the selected address to enable the DIO functions.



NOTE:

For further information, please refer to the datasheet for the Super I/O chipset.

D.2 DIO Connector Pinouts

Pin	Description	Super I/O Pin	Super I/O Pin Description
1	Ground	N/A	N/A
2	VCC	N/A	N/A
3	Output 3	GP27	General purpose I/O port 2 bit 7.
4	Output 2	GP26	General purpose I/O port 2 bit 6.
5	Output 1	GP25	General purpose I/O port 2 bit 5.
6	Output 0	GP24	General purpose I/O port 2 bit 4.
7	Input 3	GP23	General purpose I/O port 2 bit 3.
8	Input 2	GP22	General purpose I/O port 2 bit 2.
9	Input 1	GP21	General purpose I/O port 2 bit 1.
10	Input 0	GP20	General purpose I/O port 2 bit 0.

Table 6-1: Digital I/O Connector Pinouts

D.3 Assembly Language Samples

D.3.1 Enable the DIO Input Function

The BIOS interrupt call INT 15H controls the digital I/O. An assembly program to enable digital I/O input functions is listed below.

SPCIE-C2060 PICMG 1.3 CPU Card

MOV	AX, 6F08H	Sets the digital port as input
INT	15H	Initiates the INT 15H BIOS call

D.3.2 Enable the DIO Output Function

The BIOS interrupt call INT 15H controls the digital I/O. An assembly program to enable digital I/O output functions is listed below.

MOV	AX, 6F09H	Sets the digital port as output
MOV	BL, 09H	
INT	15H	Initiates the INT 15H BIOS call

Appendix

E

Watchdog Timer

SPCIE-C2060 PICMG 1.3 CPU Card



NOTE:

The following discussion applies to DOS environment. Contact IEI support or visit the IEI website for specific drivers for other operating systems.

The Watchdog Timer is provided to ensure that standalone systems can always recover from catastrophic conditions that cause the CPU to crash. This condition may have occurred by external EMIs or a software bug. When the CPU stops working correctly, Watchdog Timer either performs a hardware reset (cold boot) or a Non-Maskable Interrupt (NMI) to bring the system back to a known state.

A BIOS function call (INT 15H) is used to control the Watchdog Timer.

INT 15H:

AH – 6FH Sub-function:	
AL – 2:	Sets the Watchdog Timer's period.
BL:	Time-out value (Its unit-second is dependent on the item "Watchdog Timer unit select" in CMOS setup).

Table E-1: AH-6FH Sub-function

Call sub-function 2 to set the time-out period of Watchdog Timer first. If the time-out value is not zero, the Watchdog Timer starts counting down. When the timer value reaches zero, the system resets. To ensure that this reset condition does not occur, calling sub-function 2 must periodically refresh the Watchdog Timer. However, the watchdog timer is disabled if the time-out value is set to zero.

A tolerance of at least 10% must be maintained to avoid unknown routines within the operating system (DOS), such as disk I/O that can be very time-consuming.

**NOTE:**

When exiting a program it is necessary to disable the Watchdog Timer, otherwise the system resets.

EXAMPLE PROGRAM:

```
; INITIAL TIMER PERIOD COUNTER
```

```
;
```

```
W_LOOP:
```

```
;
```

```
    MOV     AX, 6F02H      ;setting the time-out value  
    MOV     BL, 30         ;time-out value is 48 seconds  
    INT     15H
```

```
;
```

```
; ADD THE APPLICATION PROGRAM HERE
```

```
;
```

```
    CMP     EXIT_AP, 1     ;is the application over?  
    JNE     W_LOOP        ;No, restart the application
```

```
    MOV     AX, 6F02H      ;disable Watchdog Timer  
    MOV     BL, 0         ;  
    INT     15H
```

```
;
```

```
; EXIT ;
```

Appendix

F

Intel® Matrix Storage Manager

F.1 Introduction

The SPCIE-C2060 Series can provide data protection for serial ATA (SATA) disks via the Intel® Matrix Storage Manager using one of three fault-tolerant RAID levels: RAID 1, 5 or 10. When using two hard drives, matrix RAID allows RAID 0 and RAID 1 functions to be combined, where critical files can be stored on RAID 1, and RAID 0 can be used for non-critical items such as software. RAID 5 and RAID 0 can be combined to provide higher performance, capacity, and fault tolerance.



CAUTION!

A configured RAID volume (which may consist of multiple hard drives) appears to an operating system as a contingent storage space. The operating system will not be able to distinguish the physical disk drives contained in a RAID configuration.

F.1.1 Precautions

One key benefit a RAID configuration brings is that a single hard drive can fail within a RAID array without damaging data. With RAID1 array, a failed drive can be replaced and the RAID configuration restored.



WARNING!

Irrecoverable data loss occurs if a working drive is removed when trying to remove a failed drive. It is strongly recommended to mark the physical connections of all SATA disk drives. Drive locations can be identified by attaching stickers to the drive bays. If a drive member of a RAID array should fail, the failed drive can then be correctly identified.

SPCIE-C2060 PICMG 1.3 CPU Card



CAUTION!

Do not accidentally disconnect the SATA drive cables. Carefully route the cables within the chassis to avoid system down time.

F.2 Features and Benefits

- Supports RAID levels 0, 1, 5 and 10
- Supports connectivity to two or more disk drives
- Supported Operating Systems include: Windows XP, Windows Server 2003, Windows Server 2008, Windows Vista and Windows 7

F.3 Accessing the Intel® Matrix Storage Manager

To access the Intel® Matrix Storage Manager, please follow the steps below.

Step 1: Connect SATA drives to the system. Connect two or more SATA drives to the system. Make sure the drives have the same capacity, are the same type and have the same speed.



NOTE:

Make sure the SATA drives are EXACTLY the same when they are configured in a RAID configuration. If they are not the same size, disk drive capacity is sacrificed and overall performance affected.

Step 2: Enable SATA drives in BIOS. Start the computer and access the BIOS setup program. Enable RAID support for all SATA devices. Refer to the applicable BIOS configuration section in this user manual.

Step 3: Configure “Option ROM Messages” BIOS option to Force BIOS. This is to allow the “Press <CTRL+I> to enter Configuration Utility.....” message to

appear during the POST. Refer to the applicable BIOS configuration section in this user manual.

- Step 4: Save and Exit BIOS.** After the SATA support option is enabled, save and exit the BIOS.
- Step 5: Reboot the system.** Reboot the system after saving and exiting the BIOS.
- Step 6: Press Ctrl+I. during the system boot process.** Press Ctrl+I when prompted to enter the RAID configuration software.
- Step 7: Configure the RAID settings.** Use the Intel® Matrix Storage Manager to configure the RAID array. Brief descriptions of configuration options are given below.

F.4 Installing the Operating System to the RAID Array

To install the operating system to the RAID array some extra steps are necessary during the installation process.

- Step 1: Prepare a RAID driver floppy disk on another computer.** If installing on the RAID array a RAID driver floppy disk must be made. The RAID driver floppy disk utility is on the CD in the “5-SATA/Floppy Configuration Utility” folder. The floppy disk will be formatted and the drivers installed.
- Step 2: Restart the system with a floppy drive attached.** Attach a normal floppy drive or USB floppy drive to the system.
- Step 3: Press F6 when prompted.** During the installation process, Windows OS prompts the user to press F6 to install the RAID drivers. Press F6 and choose from the drivers on the floppy disk.
- Step 4: Install the OS.** Continue with OS installation as usual.

Appendix

G

Hazardous Materials Disclosure

G.1 Hazardous Materials Disclosure Table for IPB Products Certified as RoHS Compliant Under 2002/95/EC Without Mercury

The details provided in this appendix are to ensure that the product is compliant with the Peoples Republic of China (China) RoHS standards. The table below acknowledges the presences of small quantities of certain materials in the product, and is applicable to China RoHS only.

A label will be placed on each product to indicate the estimated “Environmentally Friendly Use Period” (EFUP). This is an estimate of the number of years that these substances would “not leak out or undergo abrupt change.” This product may contain replaceable sub-assemblies/components which have a shorter EFUP such as batteries and lamps. These components will be separately marked.

Please refer to the table on the next page.

SPCIE-C2060 PICMG 1.3 CPU Card

Part Name	Toxic or Hazardous Substances and Elements					
	Lead (Pb)	Mercury (Hg)	Cadmium (Cd)	Hexavalent Chromium (CR(VI))	Polybrominated Biphenyls (PBB)	Polybrominated Diphenyl Ethers (PBDE)
Housing	<input type="radio"/>	<input type="radio"/>	<input type="radio"/>	<input type="radio"/>	<input type="radio"/>	<input type="radio"/>
Display	<input type="radio"/>	<input type="radio"/>	<input type="radio"/>	<input type="radio"/>	<input type="radio"/>	<input type="radio"/>
Printed Circuit Board	<input type="radio"/>	<input type="radio"/>	<input type="radio"/>	<input type="radio"/>	<input type="radio"/>	<input type="radio"/>
Metal Fasteners	<input type="radio"/>	<input type="radio"/>	<input type="radio"/>	<input type="radio"/>	<input type="radio"/>	<input type="radio"/>
Cable Assembly	<input type="radio"/>	<input type="radio"/>	<input type="radio"/>	<input type="radio"/>	<input type="radio"/>	<input type="radio"/>
Fan Assembly	<input type="radio"/>	<input type="radio"/>	<input type="radio"/>	<input type="radio"/>	<input type="radio"/>	<input type="radio"/>
Power Supply Assemblies	<input type="radio"/>	<input type="radio"/>	<input type="radio"/>	<input type="radio"/>	<input type="radio"/>	<input type="radio"/>
Battery	<input type="radio"/>	<input type="radio"/>	<input type="radio"/>	<input type="radio"/>	<input type="radio"/>	<input type="radio"/>

O: This toxic or hazardous substance is contained in all of the homogeneous materials for the part is below the limit requirement in SJ/T11363-2006

X: This toxic or hazardous substance is contained in at least one of the homogeneous materials for this part is above the limit requirement in SJ/T11363-2006

此附件旨在确保本产品符合中国 RoHS 标准。以下表格标示此产品中某有毒物质的含量符合中国 RoHS 标准规定的限量要求。

本产品上会附有“环境友好使用期限”的标签，此期限是估算这些物质“不会有泄漏或突变”的年限。本产品可能包含有较短的环境友好使用期限的可替换元件，像是电池或灯管，这些元件将会单独标示出来。

部件名称	有毒有害物质或元素					
	铅 (Pb)	汞 (Hg)	镉 (Cd)	六价铬 (CR(VI))	多溴联苯 (PBB)	多溴二苯 醚 (PBDE)
壳体	○	○	○	○	○	○
显示	○	○	○	○	○	○
印刷电路板	○	○	○	○	○	○
金属螺帽	○	○	○	○	○	○
电缆组装	○	○	○	○	○	○
风扇组装	○	○	○	○	○	○
电力供应组装	○	○	○	○	○	○
电池	○	○	○	○	○	○

○: 表示该有毒有害物质在该部件所有物质材料中的含量均在 SJ/T11363-2006 标准规定的限量要求以下。
 X: 表示该有毒有害物质至少在该部件的某一均质材料中的含量超出 SJ/T11363-2006 标准规定的限量要求。