

100KSPS 16-bit Analog Input Board for PCI Express Low Profile

AI-1664LA-LPE



This product is a Low Profile, PCI Express bus-compliant interface board used to provide an analog signal input function on a PC. This product is multi-channels and multifunction type with 16-bit analog input 64 channels (single-ended input 64 channels or differential input 32 channels), digital I/O and counter function. This product carries buffer memory for 1K of data, allowing sampling to be performed in a variety of trigger / clock conditions.

Windows/Linux driver and full-fledged data logger software "C-LOGGER" is bundled with this product. Possible to be used as a data recording device for MATLAB and LabVIEW, with dedicated libraries.

* Specifications, color and design of the products are subject to change without notice.

Features

High-precision analog input 64 channels, each 4 channels for digital I/O and counter 1 channel

This product has analog input (10 μ sec / channel, 16-bit, 64 channels), analog input control signal (LVTTTL level 3 channels), digital I/O (each 4 channels for LVTTTL level) and counter (32-bit, LVTTTL level 1 channel). Capable of setting the analog input at single-ended input 64 channels and differential input 32 channels.

The start/end of sampling can be controlled by software, comparison of conversion data, an external trigger, etc.

You can select from software, comparison of conversion data or an external trigger to control the start of sampling. You can select from completion of sampling for a specified number of sessions, comparison of conversion data, an external trigger or software to control forcibly the end of sampling. The sampling cycle can be selected from the internal clock or an external clock.

Equipped with buffer memory (1K data) that can be used in the FIFO or RING format

The analog input / output block contains buffer memory (1K data) that can be used in the FIFO or RING format. This allows for background analog I/O that does not depend on the operation status of the software or PC.

Digital filter function included to prevent misdetection due to chattering on external signals

A digital filter is included to prevent misdetection due to chattering on the control signal (external trigger input signal, sampling clock input signal, etc.), digital input signal and counter input signal. (Except from external clock input signal and counter gate signal)

Functions and connectors are compatible with PCI compatible board AD16-64(LPCI)LA.

The functions same with PCI compatible board AD16-64(LPCI)LA are provided. In addition, as there is compatibility in terms of connector shape and pin assignments, it is easy to migrate from the existing system.

Support for both of low-profile and standard PCI slots (interchangeable with a bundled bracket)

This product has each bracket for both low-profile size slot and standard size slot. If you wish to mount this product in a standard size slot, replace this with the standard size bracket.

Software-based calibration function

Calibration of analog input can be all performed by software. Apart from the adjustment information prepared before shipment, additional adjustment information can be stored according to the use environment.

Data logger software, Windows/Linux compatible driver libraries are attached.

Using the bundled data logger software "C-LOGGER" allows you to display recorded signal data in graphs, save files without any special program. In addition, the driver library API-PAC(W32) which makes it possible to create applications of Windows/Linux is provided.

MATLAB and LabVIEW is supported by a plug-in of dedicated library VI-DAQ.

Using the dedicated library MATLAB and VI-DAQ makes it possible to make a LabVIEW application.

Specification

Item	Specification
Analog input	
Isolated specification	Un-Isolated
Input type	Single-Ended Input or Differential Input (by software)
Input channel	64ch (single-ended input), 32ch (differential input)
Input range	Bipolar $\pm 10V$
Absolute max. input voltage	$\pm 20V$
Input impedance	1M Ω or more
Resolution	16Bit
Non-Linearity error *1 *2	$\pm 5LSB$
Conversion speed	10 μ sec/ch
Buffer memory	1k Word
Conversion start trigger	Software / external trigger
Conversion stop trigger	Number of sampling times / external trigger / software
External start signal	LVTTTL-level (Rising or falling edge can be selected by software) Digital filter (select 1 μ sec by software)
External stop signal	LVTTTL-level (Rising or falling edge can be selected by software) Digital filter (select 1 μ sec by software)
External clock signal	LVTTTL-level (Rising or falling edge can be selected by software)
Digital I/O	
Number of input channels	Un-Isolated input 4 channels (LVTTTL-level positive logic)
Number of output channels	Un-Isolated output 4 channels (LVTTTL-level positive logic)
Counter	
Number of channels	1ch
Counting system	Up count
Max. count	FFFFFFFFh (Binary data, 32bit)
Number of external inputs	2 LVTTTL (Gate/Up) Gate (High level), Up (Rising edge)
Number of external outputs	LVTTTL Count match output (positive logic, pulse output)
Response frequency	10MHz (Max.)
Common	
I/O address	64 ports boundary
Interruption level	Errors and various factors, One interrupt request line as INTA
Connector	68 pin 0.8mm pitch connector HDRA-E68W1LFDTS-SL [HONDA] or equivalent to it
Power consumption	3.3VDC 620mA (Max.)
Operating condition	0 - 50°C, 10 - 90%RH (No condensation)
Bus specification	PCI Express Base Specification Rev. 1.0a x1
Dimension (mm)	121.69(L) x 67.90(H)
Weight	90g

- *1 The non-linearity error means an error of approximately 0.1% occurs over the maximum range at 0°C and 50°C ambient temperature.
*2 At the time of the source use of a signal which built in the high-speed operational amplifier.

Board Dimensions

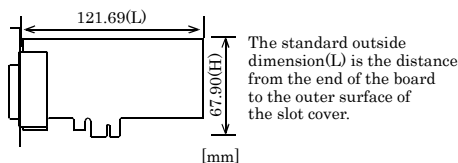

Support Software

Windows version of analog I/O driver API-AIO(WDM) [Stored on the bundled CD-ROM driver library API-PAC(W32)]

The API-AIO(WDM) is the Windows version driver library software that provides products in the form of Win32 API functions (DLL). Various sample programs such as Visual Basic and Visual C++, etc and diagnostic program useful for checking operation is provided.

< Operating environment >

OS Windows Vista, XP, Server 2003, 2000
Adaptation language Visual Basic, Visual C++, Visual C#, Delphi, C++ Builder

You can download the updated version from the CONTEC's Web site (<http://www.contec.com/apipac/>). For more details on the supported OS, applicable language and new information, please visit the CONTEC's Web site.

Linux version of analog I/O driver API-AIO(LNX) [Stored on the bundled CD-ROM driver library API-PAC(W32)]

The API-AIO(LNX) is the Linux version driver software which provides device drivers (modules) by shared library and kernel version. Various sample programs of gcc are provided.

< Operating environment >

OS RedHatLinux, TurboLinux
(For details on supported distributions, refer to Help available after installation.)

Adaptation language gcc

You can download the updated version from the CONTEC's Web site (<http://www.contec.com/apipac/>). For more details on the supported OS, applicable language and new information, please visit the CONTEC's Web site.

Data Logger Software C-LOGGER (Supplied: Stored on the API-PAC(W32) CD-ROM)

C-LOGGER is a data logger software program compatible with our analog I/O products. This program enables the graph display of recorded signal data, zoom observation, file saving, and dynamic transfer to the spreadsheet software "Excel". No troublesome programming is required.

CONTEC provides download services (at <http://www.contec.com/clogger>) to supply the updated drivers. For details, refer to the C-LOGGER Users Guide or our website.

< Operating environment >

OS Windows Vista, XP, Server 2003, 2000

Data Acquisition library for MATLAB ML-DAQ (Available for downloading (free of charge) from the CONTEC web site.)

This is the library software which allows you to use our analog I/O device products on MATLAB by the MathWorks. Each function is offered in accordance with the interface which is integrated in MATLAB's Data Acquisition Toolbox.

See <http://www.contec.com/mldaq/> for details and download of ML-DAQ.

Data acquisition VI library for LabVIEW VI-DAQ (Available for downloading (free of charge) from the CONTEC web site.)

This is a VI library to use in National Instruments LabVIEW. VI-DAQ is created with a function form similar to that of LabVIEW's Data Acquisition VI, allowing you to use various devices without complicated settings.

See <http://www.contec.com/vidaq/> for details and download of VI-DAQ.

Cable & Connector

Cable(Option)

Shielded cables with two-ended connector
for 68-pin half-pitch connector : PCB68PS-0.5P (0.5m)
: PCB68PS-1.5P (1.5m)

Shielded cables with single-ended connector
for 68-pin half-pitch connector : PCA68PS-0.5P (0.5m)
: PCA68PS-1.5P (1.5m)

68/96-pin conversion shielded cable
for analog input/output : ADC-68M/96F (0.5m)

* Two sets of cables are required to use both connector CNA and CNB.

Accessories

Accessories (Option)

Screw Terminal (M2.5 x 96P) : DTP-64(PC) *1*3

Screw Terminal (M3 x 68P) : EPD-68A *2*3*4

Screw Terminal (M3 x 96P) : EPD-96A *1*3*4

Screw Terminal (M3.5 x 96P) : EPD-96 *1*3

BNC Terminal Unit (analog input 32ch) : ATP-32F *1*3

BNC Terminal Unit (analog input 8ch) : ATP-8 *1*3*5

*1 ADC-68M/96F optional cable is required separately.

*2 PCB68PS-0.5P or PCB68PS-1.5P optional cable is required separately.

*3 Two sets of cables are required to use both connector CNA and CNB.

*4 "Spring-up" type terminal is used to prevent terminal screws from falling off.

*5 Can be used in CNA channels 0 - 7 or CNB channels 32 - 39.

* For details on the range channels available to each terminal panel, see Page 3 "Connecting example of option".

* Check the CONTEC's Web site for more information on these options.

Packing List

Board [AI-1664LA-LPE] ...1

First step guide ... 1

CD-ROM *1 [API-PAC(W32)] ...1

Standard-sized bracket ...1

*1 The CD-ROM contains the driver software and User's Guide.

Block Diagram

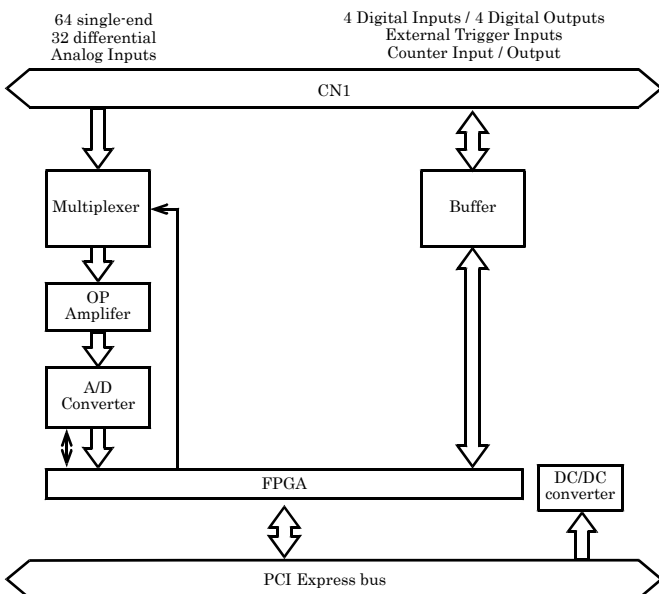

How to connect the connectors

Connector shape

The optional connector cable (PCB68PS-**P, ADC-68M/96F or PCA68PS-**P) is used to connect the board to external devices. The cable is used together with a terminal block to connect external devices. Two sets of cables are required depending on the number of channels used.

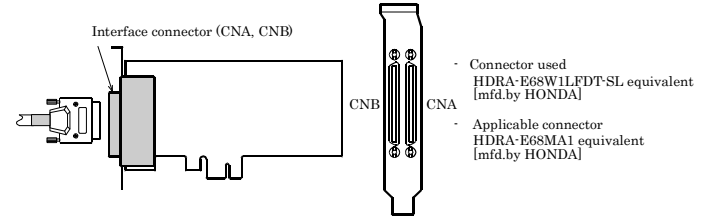

* Please refer to Page 3 for more information on the supported cable and accessories.

Connecting example of option

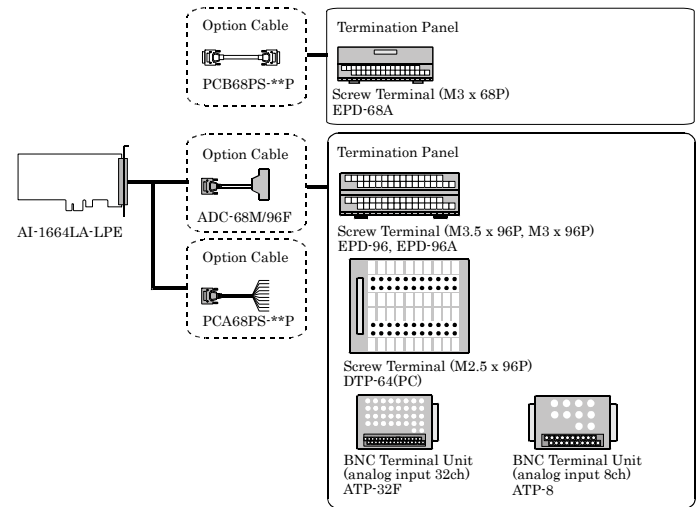

Each terminal block accepts the following ranges of channels.

	Connector at board side connection destination	Analog input		Analog input control signal *1	Digital input Digital output	Counter I/O *2
		Single-ended input	Differential input			
EPD-96A	Only CNA is used.	channel 0 - 31	channel 0 - 15	O	O	O
EPD-96	Only CNB is used.	channel 32 - 63	channel 16 - 31	--	--	--
EPD-68A	CNA/B is used *3	channel 0 - 63	channel 0 - 31	O *4	O *4	O *4
ATP-32F	Only CNA is used.	channel 0 - 31	--	O	O	O
	Only CNB is used.	channel 32 - 63	--	--	--	--
ATP-8	CNA/B is used *3	channel 0 - 63	--	O *4	O *4	O *4
	Only CNA is used.	channel 0 - 7	--	O	O	O
ATP-8	Only CNB is used.	channel 32 - 39 *5	--	--	--	--
	CNA/B is used *3	channel 0 - 7, 32 - 39 *5	--	O *4	O *4	O *4

*1: AI External Start Trigger Input, AI External Stop Trigger Input, AI External Clock Trigger Input

*2: Counter Gate Control Input, Counter Up Clock Input, Counter Output

*3: Two sets of terminal blocks and optional cables are required each.

*4: Make wiring on the CAN side.

*5: Two or more only of channel 32 - 39 sampling cannot be done.

Connector Pin Assignment

Single-Ended Input (CNA, CNB)

N.C.	68	34	N.C.	1	36	Analog Ground (for AI)
N.C.	67	33	N.C.	2	35	Analog Ground (for AI)
N.C.	66	32	N.C.	3	37	Analog Ground (for AI)
N.C.	65	31	N.C.	4	38	Analog Input 16
N.C.	64	30	N.C.	5	39	Analog Input 17
N.C.	63	29	N.C.	6	40	Analog Input 18
N.C.	62	28	N.C.	7	41	Analog Input 19
Digital Ground	61	27	N.C.	8	42	Analog Ground (for AI)
N.C.	60	26	N.C.	9	43	Analog Input 20
N.C.	59	25	N.C.	10	44	Analog Input 21
Digital Ground	58	24	N.C.	11	45	Analog Input 22
N.C.	57	23	N.C.	12	46	Analog Input 23
Analog Input 63	56	22	Analog Input 47	13	47	Analog Ground (for AI)
Analog Input 62	55	21	Analog Input 46	14	48	Analog Input 24
Analog Input 61	54	20	Analog Input 45	15	49	Analog Input 25
Analog Input 60	53	19	Analog Input 44	16	50	Analog Input 26
Analog Ground (for AI)	52	18	Analog Ground (for AI)	17	51	Analog Input 27
Analog Input 59	51	17	Analog Input 43	18	52	Analog Ground (for AI)
Analog Input 58	50	16	Analog Input 42	19	53	Analog Input 28
Analog Input 57	49	15	Analog Input 41	20	54	Analog Input 29
Analog Input 56	48	14	Analog Input 40	21	55	Analog Input 30
Analog Ground (for AI)	47	13	Analog Ground (for AI)	22	56	Analog Input 31
Analog Input 55	46	12	Analog Input 39	23	57	Input Control External Sampling Start Trigger Input
Analog Input 54	45	11	Analog Input 38	24	58	Digital Ground
Analog Input 53	44	10	Analog Input 37	25	59	N.C.
Analog Input 52	43	9	Analog Input 36	26	60	N.C.
Analog Input 51	42	8	Analog Ground (for AI)	27	61	Digital Ground
Analog Input 50	41	7	Analog Input 35	28	62	N.C.
Analog Ground (for AI)	40	6	Analog Input 34	29	63	Digital Input 01
Analog Input 49	39	5	Analog Input 33	30	64	Digital Input 03
Analog Input 48	38	4	Analog Input 32	31	65	Digital Output 01
Analog Ground (for AI)	37	3	Analog Ground (for AI)	32	66	Digital Output 03
Analog Ground (for AI)	36	2	N.C.	33	67	Reserved
Analog Ground (for AI)	35	1	N.C.	34	68	Counter Input

Analog Input00 - Analog Input63	Analog input signal. The numbers correspond to channel numbers.
Analog Ground	Common analog ground for analog input signals.
AI External Start Trigger Input	External trigger input for starting analog input sampling.
AI External Stop Trigger Input	External trigger input for stopping analog input sampling.
AI External Sampling Clock Input	External sampling clock input for analog input.
Digital Input00 - Digital Input03	Digital input signal.
Digital Output00 - Digital Output03	Digital output signal.
Counter Gate Control Input	Gate control input signal for counter.
Counter Up Clock Input	Count-up clock input signal for counter.
Counter Output	Count output signal.
Digital Ground	Common digital ground for digital I/O signals, external trigger inputs, external sampling clock inputs, and counter I/O signals.
Reserved	Reserved pin
N.C.	No connection to this pin.

⚠ CAUTION

Do not connect any of the outputs and power outputs to the analog or digital ground. Neither connect outputs to each other. Doing either can result in a fault.

If analog and digital ground are shorted together, noise on the digital signals may affect the analog signals. Accordingly, analog and digital ground should be separated. Leave "Reserved" pins unconnected. Connecting these pins may cause a fault in the board.

Single-Ended Input (ADC-68M/96F)

N.C.	B01	A01	N.C.	A48	B48	N.C.
N.C.	B02	A02	N.C.	A47	B47	N.C.
N.C.	B03	A03	N.C.	A46	B46	N.C.
N.C.	B04	A04	N.C.	A45	B45	N.C.
N.C.	B05	A05	N.C.	A44	B44	Analog Input 08
N.C.	B06	A06	N.C.	A43	B43	Analog Input 24
N.C.	B07	A07	N.C.	A42	B42	Analog Input 09
Digital Ground	B08	A08	Digital Ground	A41	B41	Analog Input 25
N.C.	B09	A09	N.C.	A40	B40	N.C.
N.C.	B10	A10	N.C.	A39	B39	N.C.
N.C.	B11	A11	N.C.	A38	B38	Analog Input 10
N.C.	B12	A12	N.C.	A37	B37	Analog Input 26
N.C.	B13	A13	N.C.	A36	B36	Analog Input 11
N.C.	B14	A14	N.C.	A35	B35	Analog Input 27
N.C.	B15	A15	N.C.	A34	B34	Analog Ground (for AI)
N.C.	B16	A16	N.C.	A33	B33	Analog Ground (for AI)
N.C.	B17	A17	N.C.	A32	B32	Analog Input 12
N.C.	B18	A18	N.C.	A31	B31	Analog Input 28
N.C.	B19	A19	N.C.	A30	B30	Analog Input 13
N.C.	B20	A20	N.C.	A29	B29	Analog Input 29
Analog Ground (for AI)	B21	A21	Analog Ground (for AI)	A28	B28	N.C.
Analog Ground (for AI)	B22	A22	Analog Ground (for AI)	A27	B27	N.C.
Analog Input 63	B23	A23	Analog Input 55	A26	B26	Analog Input 14
Analog Input 62	B24	A24	Analog Input 56	A25	B25	Analog Input 30
Analog Input 61	B25	A25	Analog Input 57	A24	B24	Analog Input 15
Analog Input 60	B26	A26	Analog Input 58	A23	B23	Analog Input 31
N.C.	B27	A27	N.C.	A22	B22	Analog Input 16
N.C.	B28	A28	N.C.	A21	B21	Analog Ground (for AI)
Analog Input 61	B29	A29	Analog Input 53	A20	B20	N.C.
Analog Input 60	B30	A30	Analog Input 54	A19	B19	N.C.
Analog Input 59	B31	A31	Analog Input 55	A18	B18	Digital Output 00
Analog Input 58	B32	A32	Analog Input 56	A17	B17	Digital Output 01
Analog Ground (for AI)	B33	A33	Analog Ground (for AI)	A16	B16	Digital Output 02
Analog Input 59	B34	A34	Analog Ground (for AI)	A15	B15	Digital Output 03
Analog Input 58	B35	A35	Analog Input 51	A14	B14	N.C.
Analog Input 57	B36	A36	Analog Input 52	A13	B13	N.C.
Analog Input 56	B37	A37	Analog Input 53	A12	B12	N.C.
Analog Input 45	B38	A38	Analog Input 54	A11	B11	N.C.
N.C.	B39	A39	N.C.	A10	B10	N.C.
N.C.	B40	A40	N.C.	A09	B09	N.C.
Analog Input 57	B41	A41	Analog Input 49	A08	B08	Digital Ground
Analog Input 41	B42	A42	Analog Input 53	A07	B07	N.C.
Analog Input 56	B43	A43	Analog Input 48	A06	B06	N.C.
Analog Input 40	B44	A44	Analog Input 32	A05	B05	N.C.
N.C.	B45	A45	Analog Ground (for AI)	A04	B04	N.C.
N.C.	B46	A46	N.C.	A03	B03	N.C.
N.C.	B47	A47	Analog Ground (for AI)	A02	B02	N.C.
N.C.	B48	A48	N.C.	A01	B01	N.C.

[] shows the pin No. specified by HONDA TSUSHIN KOGYO CO., LTD.

Analog Input00 - Analog Input63	Analog input signal. The numbers correspond to channel numbers.
Analog Ground	Common analog ground for analog input signals.
AI External Start Trigger Input	External trigger input for starting analog input sampling.
AI External Stop Trigger Input	External trigger input for stopping analog input sampling.
AI External Sampling Clock Input	External sampling clock input for analog input.
Digital Input00 - Digital Input03	Digital input signal.
Digital Output00 - Digital Output03	Digital output signal.
Counter Gate Control Input	Gate control input signal for counter.
Counter Up Clock Input	Count-up clock input signal for counter.
Counter Output	Count output signal.
Digital Ground	Common digital ground for digital I/O signals, external trigger inputs, external sampling clock inputs, and counter I/O signals.
Reserved	Reserved pin
N.C.	No connection to this pin.

⚠ CAUTION

Do not connect any of the outputs and power outputs to the analog or digital ground. Neither connect outputs to each other. Doing either can result in a fault.

If analog and digital ground are shorted together, noise on the digital signals may affect the analog signals. Accordingly, analog and digital ground should be separated. Leave "Reserved" pins unconnected. Connecting these pins may cause a fault in the board.

Differential Input (CNA, CNB)

N.C	68	34	N.C	1	34	Analog Ground (for AI)
N.C	67	33	N.C	2	36	Analog Ground (for AI)
N.C	66	32	N.C	3	37	Analog Ground (for AI)
N.C	65	31	N.C	4	38	Analog Input 00(-)
N.C	64	30	N.C	5	39	Analog Input 01(-)
N.C	63	29	N.C	6	40	Analog Input 02(-)
N.C	62	28	N.C	7	41	Analog Input 03(-)
Digital Ground	61	27	N.C	8	42	Analog Ground (for AI)
N.C	60	26	N.C	9	43	Analog Input 04(-)
N.C	59	25	N.C	10	44	Analog Input 05(-)
Digital Ground	58	24	N.C	11	45	Analog Input 06(-)
N.C	57	23	N.C	12	46	Analog Input 07(-)
Analog Input 31(-)	56	22	Analog Input 31(+)	13	47	Analog Ground (for AI)
Analog Input 30(-)	55	21	Analog Input 30(+)	14	48	Analog Input 08(-)
Analog Input 29(-)	54	20	Analog Input 29(+)	15	49	Analog Input 09(-)
Analog Input 28(-)	53	19	Analog Input 28(+)	16	50	Analog Input 10(-)
Analog Ground (for AI)	52	18	Analog Ground (for AI)	17	51	Analog Input 11(-)
Analog Input 27(-)	51	17	Analog Input 27(+)	18	52	Analog Ground (for AI)
Analog Input 26(-)	50	16	Analog Input 26(+)	19	53	Analog Input 12(-)
Analog Input 25(-)	49	15	Analog Input 25(+)	20	54	Analog Input 13(-)
Analog Input 24(-)	48	14	Analog Input 24(+)	21	55	Analog Input 14(-)
Analog Ground (for AI)	47	13	Analog Ground (for AI)	22	56	Analog Input 15(-)
Analog Input 23(-)	46	12	Analog Input 23(+)	23	57	Input Control External Sampling Start Trigger Input
Analog Input 22(-)	45	11	Analog Input 22(+)	24	58	Digital Ground
Analog Input 21(-)	44	10	Analog Input 21(+)	25	59	N.C
Analog Ground (for AI)	43	9	Analog Input 20(+)	26	60	N.C
Analog Input 19(-)	42	8	Analog Ground (for AI)	27	61	Digital Ground
Analog Input 18(-)	41	7	Analog Input 19(+)	28	62	N.C
Analog Input 17(-)	40	6	Analog Input 18(+)	29	63	Digital Input 00
Analog Input 16(-)	39	5	Analog Input 17(+)	30	64	Digital Input 03
Analog Ground (for AI)	38	4	Analog Input 16(+)	31	65	Digital Output 00
Analog Ground (for AI)	37	3	Analog Ground (for AI)	32	66	Digital Output 02
Analog Ground (for AI)	36	2	N.C	33	67	Counter Gate Control Input
Analog Ground (for AI)	35	1	N.C	34	68	Counter Clock Input



Analog Input00 - Analog Input31	Analog input signal. The numbers correspond to channel numbers.
Analog Ground	Common analog ground for analog input signals.
AI External Start Trigger Input	External trigger input for starting analog input sampling.
AI External Stop Trigger Input	External trigger input for stopping analog input sampling.
AI External Sampling Clock Input	External sampling clock input for analog input.
Digital Input00 - Digital Input03	Digital input signal.
Digital Output00 - Digital Output03	Digital output signal.
Counter Gate Control Input	Gate control input signal for counter.
Counter Up Clock Input	Count-up clock input signal for counter.
Counter Output	Count output signal.
Digital Ground	Common digital ground for digital I/O signals, external trigger inputs, external sampling clock inputs, and counter I/O signals.
Reserved	Reserved pin
N.C.	No connection to this pin.

⚠ CAUTION

Do not connect any of the outputs and power outputs to the analog or digital ground. Neither connect outputs to each other. Doing either can result in a fault.

If analog and digital ground are shorted together, noise on the digital signals may affect the analog signals. Accordingly, analog and digital ground should be separated. Leave "Reserved" pins unconnected. Connecting these pins may cause a fault in the board.

Differential Input (ADC-68M/96F)

N.C	B01	A01	N.C	N.C	A48	B48	N.C
N.C	B02	A02	N.C	Analog Ground (for AI)	A47	B47	N.C
N.C	B03	A03	N.C	N.C	A46	B46	N.C
N.C	B04	A04	N.C	Analog Ground (for AI)	A45	B45	N.C
N.C	B05	A05	N.C	Analog Input 00(-)	A44	B44	Analog Input 08(+)
N.C	B06	A06	N.C	Analog Input 01(-)	A43	B43	Analog Input 09(+)
N.C	B07	A07	N.C	Analog Input 02(-)	A42	B42	Analog Input 10(+)
Digital Ground	B08	A08	Digital Ground	Analog Input 03(-)	A41	B41	Analog Input 11(+)
N.C	B09	A09	N.C	N.C	A40	B40	N.C
N.C	B10	A10	N.C	N.C	A39	B39	N.C
N.C	B11	A11	N.C	Analog Input 02(+)	A38	B38	Analog Input 10(+)
N.C	B12	A12	N.C	Analog Input 03(+)	A37	B37	Analog Input 11(+)
N.C	B13	A13	N.C	Analog Input 04(+)	A36	B36	Analog Input 12(+)
N.C	B14	A14	N.C	Analog Input 05(+)	A35	B35	Analog Input 13(+)
N.C	B15	A15	N.C	Analog Ground (for AI)	A34	B34	Analog Ground (for AI)
N.C	B16	A16	N.C	Analog Ground (for AI)	A33	B33	Analog Ground (for AI)
N.C	B17	A17	N.C	Analog Input 04(-)	A32	B32	Analog Input 12(+)
N.C	B18	A18	N.C	Analog Input 05(-)	A31	B31	Analog Input 13(+)
N.C	B19	A19	N.C	Analog Input 06(-)	A30	B30	Analog Input 14(+)
N.C	B20	A20	N.C	Analog Input 07(-)	A29	B29	Analog Input 15(+)
N.C	B21	A21	Analog Ground (for AI)	N.C	A28	B28	N.C
N.C	B22	A22	Analog Ground (for AI)	N.C	A27	B27	N.C
N.C	B23	A23	Analog Input 23(-)	Analog Input 08(+)	A26	B26	Analog Input 14(+)
N.C	B24	A24	Analog Input 23(+)	Analog Input 09(+)	A25	B25	Analog Input 15(+)
N.C	B25	A25	Analog Input 30(-)	Analog Input 10(+)	A24	B24	Analog Input 16(+)
N.C	B26	A26	Analog Input 30(+)	Analog Input 11(+)	A23	B23	Analog Input 17(+)
N.C	B27	A27	N.C	Analog Ground (for AI)	A22	B22	Analog Ground (for AI)
N.C	B28	A28	N.C	Analog Ground (for AI)	A21	B21	Analog Ground (for AI)
Analog Input 29(-)	B29	A29	Analog Input 21(-)	N.C	A20	B20	N.C
Analog Input 29(+)	B30	A30	Analog Input 21(+)	N.C	A19	B19	N.C
Analog Input 28(-)	B31	A31	Analog Input 20(-)	Digital Input 00	A18	B18	Digital Output 00
Analog Input 28(+)	B32	A32	Analog Input 20(+)	Digital Input 01	A17	B17	Digital Output 01
Analog Ground (for AI)	B33	A33	Analog Ground (for AI)	Digital Input 02	A16	B16	Digital Output 02
Analog Ground (for AI)	B34	A34	Analog Ground (for AI)	Digital Input 03	A15	B15	Digital Output 03
Analog Input 27(-)	B35	A35	Analog Input 19(-)	N.C	A14	B14	N.C
Analog Input 27(+)	B36	A36	Analog Input 19(+)	N.C	A13	B13	N.C
Analog Input 26(-)	B37	A37	Analog Input 18(-)	N.C	A12	B12	N.C
Analog Input 26(+)	B38	A38	Analog Input 18(+)	N.C	A11	B11	N.C
N.C	B39	A39	N.C	N.C	A10	B10	N.C
N.C	B40	A40	N.C	N.C	A09	B09	N.C
Analog Input 25(-)	B41	A41	Analog Input 17(-)	Digital Ground	A08	B08	Digital Ground
Analog Input 25(+)	B42	A42	Analog Input 17(+)	Input Control External Sampling Clock Input	A07	B07	N.C
Analog Input 24(-)	B43	A43	Analog Input 16(-)	Input Control External Sampling Start Trigger Input	A06	B06	N.C
Analog Input 24(+)	B44	A44	Analog Input 16(+)	Input Control External Sampling Stop Trigger Input	A05	B05	N.C
N.C	B45	A45	Analog Ground (for AI)	Counter Clock Input	A04	B04	N.C
N.C	B46	A46	N.C	Reserved (Counter Input)	A03	B03	N.C
N.C	B47	A47	Analog Ground (for AI)	Counter Gate Control Input	A02	B02	N.C
N.C	B48	A48	N.C	Counter Count-up Pulse Output	A01	B01	N.C

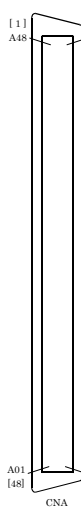
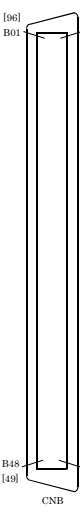

[] shows the pin No. specified by HONDA TSUSHIN KOGYO CO., LTD.

Analog Input00 - Analog Input31	Analog input signal. The numbers correspond to channel numbers.
Analog Ground	Common analog ground for analog input signals.
AI External Start Trigger Input	External trigger input for starting analog input sampling.
AI External Stop Trigger Input	External trigger input for stopping analog input sampling.
AI External Sampling Clock Input	External sampling clock input for analog input.
Digital Input00 - Digital Input03	Digital input signal.
Digital Output00 - Digital Output03	Digital output signal.
Counter Gate Control Input	Gate control input signal for counter.
Counter Up Clock Input	Count-up clock input signal for counter.
Counter Output	Count output signal.
Digital Ground	Common digital ground for digital I/O signals, external trigger inputs, external sampling clock inputs, and counter I/O signals.
Reserved	Reserved pin
N.C.	No connection to this pin.

⚠ CAUTION

Do not connect any of the outputs and power outputs to the analog or digital ground. Neither connect outputs to each other. Doing either can result in a fault.

If analog and digital ground are shorted together, noise on the digital signals may affect the analog signals. Accordingly, analog and digital ground should be separated. Leave "Reserved" pins unconnected. Connecting these pins may cause a fault in the board.

Analog Input Signal Connection

Single-ended Input

The following figure shows an example of flat cable connection. Connect separate signal and ground wires for each analog input channel on CNA/B.

Single-ended Input Connection (Flat Cable)

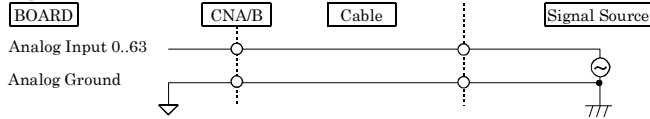

The following figure shows an example of shield cable connection. Use shielded cable if the distance between the signal source and board is long or if you want to provide better protection from noise. For each analog input channel on CNA/B, connect the core wire to the signal line and connect the shielding to ground.

Single-ended Input Connection (Shield Cable)

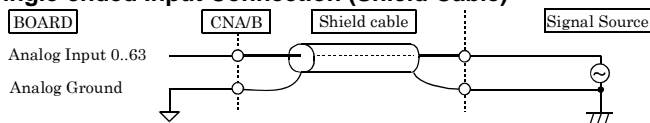

⚠ CAUTION

If the signal source contains over 1MHz signals, the signal may effect the cross-talk noise between channels.

If the board and the signal source receive noise or the distance between the board and the signal source is too long, data may not be input properly.

An input analog signal should not exceed the maximum input voltage (relate to the board analog ground). If it exceeds the maximum voltage, the board may be damaged.

Connect all the unused analog input channels to analog ground.

The signal connected to an input pin may fluctuate after switching of the multiplexer. If this occurs, shorten the cable between the signal source and the analog input pin or insert a high-speed amplifier as a buffer between the two to reduce the fluctuation.

In the channel switching, the multiplexer does the electrical charge and discharge on the internal capacitor according to the signal voltage. Therefore, the voltage from the previous switching state may go into the next channel. It might cause the error of the signal source action. If this occurs, insert a high-speed amplifier as a buffer between the signal source and the analog input pin to reduce the fluctuation.

An input pin may fail to obtain input data normally when the signal source connected to the pin has high impedance. If this is the case, change the signal source to one with lower output impedance or insert a high-speed amplifier buffer between the signal source and the analog input pin to reduce the effect.

Differential Input

The following figure shows an example of flat cable connection.

For each analog input channel on CNA/B, connect the "+" input to the signal and connect the "-" input to the signal source ground. Also connect the analog ground on the board to the signal source ground.

Differential Input Connection (Flat Cable)

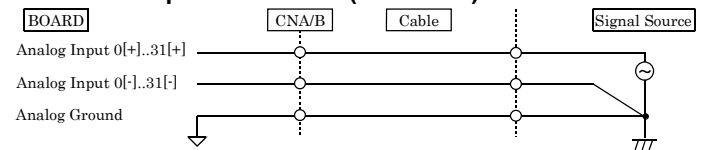

The following figure shows an example of shielded cable connection. Use shielded cable if the distance between the signal source and board is long or if you want to provide better protection from noise. For each analog input channel on CNA/B, connect the "+" input to the signal and connect the "-" input to the signal source ground. Also connect the analog ground on the board and the signal source ground to the shielding.

Differential Input Connection (Shield Cable)

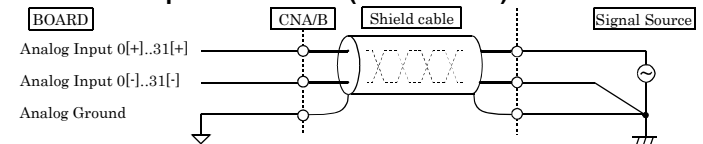

⚠ CAUTION

If the signal source contains over 1MHz signals, the signal may effect the cross-talk noise between channels.

When the analog ground is not connected, the conversion data is not determined.

If the board and the signal source receive noise or the distance between the board and the signal source is too long, data may not be input properly.

An input analog signal should not exceed the maximum input voltage (relate to the board analog ground). If it exceeds the maximum voltage, the board may be damaged.

Connect all the unused analog input channels to analog ground.

The signal connected to an input pin may fluctuate after switching of the multiplexer. If this occurs, shorten the cable between the signal source and the analog input pin or insert a high-speed amplifier as a buffer between the two to reduce the fluctuation.

In the channel switching, the multiplexer does the electrical charge and discharge on the internal capacitor according to the signal voltage. Therefore, the voltage from the previous switching state may go into the next channel. It might cause the error of the signal source action. If this occurs, insert a high-speed amplifier as a buffer between the signal source and the analog input pin to reduce the fluctuation.

An input pin may fail to obtain input data normally when the signal source connected to the pin has high impedance. If this is the case, change the signal source to one with lower output impedance or insert a high-speed amplifier buffer between the signal source and the analog input pin to reduce the effect.

Digital I/O signals, Counter signals and Control signals Connection

The following sections show examples of how to connect digital I/O signals, counter I/O signals, and other control I/O signals (external trigger input signals, sampling clock input signals, etc.). All the digital I/O signals and control signals are TTL level signals.

Digital Input Connection

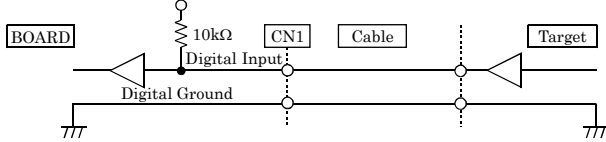

Digital Output Connection

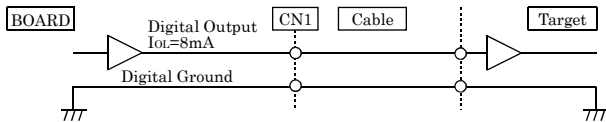

Counter input signal control

The counter gate control input (see Connector Pin Assignment in Page4) enables or disables the external clock input to the counter. You can use this function to control the external clock input to the counter. The external clock input to the counter is enabled when the input is "High" and disabled when the input is "Low". As the pin has an internal pull-up on the board (or card), the default if not connected is "High". As a result, the external clock for the counter is enabled if this pin is not connected.

⚠ CAUTION

Do not short the output signals to analog ground, digital ground, and/or power line. Doing so may damage the board.

Difference from AD16-64(LPCI)LA

The functions same with conventional product of AD16-64(LPCI)LA are provided with this product. In addition, as there is compatibility in terms of connector shape and pin assignments, it is easy to migrate from the existing system. So you can use the same operating procedures as AD16-64(LPCI)LA.

There are some differences in specifications as shown below.

	AI-1664LA-LPE	AD16-64(LPCI)LA
Power consumption	+3.3VDC 620 mA (Max.)	+5VDC 450 mA (Max.)
Bus specification	PCI Express Base Specification Rev. 1.0a x1	PCI (32-bit, 33MHz, Universal key shapes supported)
External start signal	LVTTTL-level	TTL-level
External stop signal	LVTTTL-level	TTL-level
External clock signal	LVTTTL-level	TTL-level
Digital Input/Output	LVTTTL-level positive logic	TTL-level positive logic
External Counter Input/Output	LVTTTL-level	TTL-level
Dimension (mm)	121.69 (L)x67.90(H)	121.69(L)x63.41(H)
Weight	90g	60g