

IEI Quick Mounting Technology

IEI IQ mount design allows the AFOLUX series to be easily integrated into a diverse variety of applications. The arm design can be used for industrial controls, the panel mount for kiosk devices, the wall mount for e-home terminals and the stand design for thin client applications.



IQ mounting



VESA Mounting Standards

The AFOLUX panel PC series has four mounting holes compliant with the VESA mounting standard (75mm x 75mm/100mm x 100mm) on the rear panel for stand mounting and other mounting methods.

Stands

- STAND-A08 supports up to 5.0Kg
- STAND-A12 supports up to 5.0Kg
- STAND-A19 supports up to 7.5Kg
- STAND-B19 supports up to 7.2Kg

Easy Stand



Comfortable Stand



Panel Mount Kits

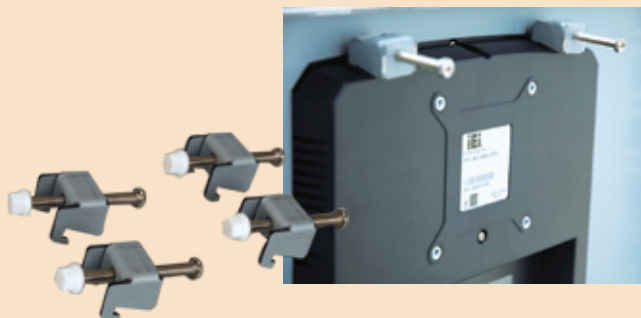

Wall Mount Kits

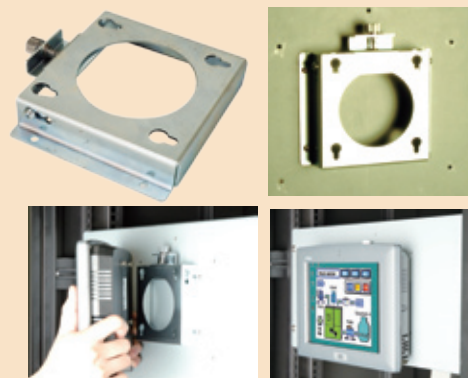

AFOLUX

7"-19" All-in-one Panel PC



Headquarters

IEI Technology Corp.

No. 29, Jhongsing Rd., Sijhih City, Taipei County, 221, Taiwan
 TEL : +886-2-86916798 FAX : +886-2-66160028
 sales@ieiworld.com www.ieiworld.com

America

IEI Technology USA Corp.

168 University Parkway, Pomona, CA 91768
 Tel: +1-909-595-2819 Fax: +1-909-595-2816
 sales@usa.ieiworld.com www.usa.ieiworld.com

China

IEI Technology SH Corp.

515 Shen Fu RD. XinZhuang Industrial Develop Zone
 TEL : +86-21-5442 9000 FAX : +86-21-5442 9100
 sales@ieiworld.com.cn www.ieiworld.com.cn

AFO LUX *Panel PC Series*

7"-19" All-in-one Panel PC

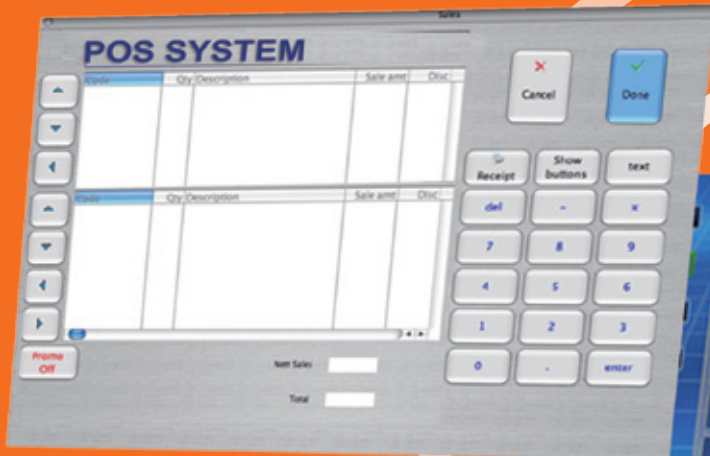

For POS



For Home Automation



For Industrial Automation



For Car PC

Maximize Your Business Potential

The streamline AFOLUX series all-in-one panel PC offers installation versatility with its wide ranging mounting options that help maximize your business potential



AFOLUX AMD Geode™ LX 800 Series



AFL-07A-LX-R11
Selectable AT/ATX Power Mode

7"

7" embedded fanless panel PC
AMD Geode™ LX 800 CPU

- Resolution: 800x480
- Brightness (cd/m²): 350
- Touch screen
- Integrated audio speakers
- 256/512 MB memory preinstalled
- Complete I/O support:
 - 1 x RS-232 COM port
 - 1 x RS-232/422/485 COM port
 - 2 x USB 2.0 ports
 - 2 x LAN ports
- 802.11b/g wireless antenna inside
- Preinstalled Bluetooth module
- The best choice for Thin Client, Windows® CE 5.0 and Windows® XP embedded

Vehicle Interior Device

- Car PC
- Transportation logistics PC

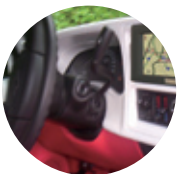

AFL-08AH-LX-R11
Selectable AT/ATX Power Mode

8.4"

8.4" embedded fanless panel PC
AMD Geode™ LX 800 CPU

- Resolution: 800x600
- Brightness (cd/m²): 450
- Touch screen
- Integrated audio speakers
- 256/512 MB memory preinstalled
- Complete I/O support:
 - 1 x RS-232 COM port
 - 1 x RS-232/422/485 COM port
 - 2 x USB 2.0 ports
 - 2 x LAN ports
- 802.11b/g wireless antenna inside
- Preinstalled Bluetooth module
- The best choice for Thin Client, Windows® CE 5.0 and Windows® XP embedded

Industrial Automation

- Manufacturing work flow
- Factory automation
- Environmental monitoring



AFL-10A-LX
Selectable AT/ATX Power Mode

10.4"

10.4" embedded fanless panel PC
AMD Geode™ LX 800 CPU

- Resolution: 800x600
- Brightness (cd/m²): 400
- Touch screen
- Integrated audio speakers
- 256/512 MB memory preinstalled
- Complete I/O support:
 - 1 x RS-232 COM port
 - 1 x RS-232/422/485 COM port
 - 2 x USB 2.0 ports
 - 2 x LAN ports
- 802.11b/g wireless antenna inside
- Preinstalled Bluetooth module
- The best choice for Thin Client, Windows® CE 5.0 and Windows® XP embedded

POS Applications

- Mobile inventory checking
- Cashier platform



AFL-12A-LX-R11
Selectable AT/ATX Power Mode

12.1"

12.1" embedded fanless panel PC
AMD Geode™ LX 800 CPU

- Resolution: 1024x768
- Brightness (cd/m²): 450
- Touch screen
- Integrated audio speakers
- 256/512 MB memory preinstalled
- Complete I/O support:
 - 1 x RS-232 COM port
 - 1 x RS-232/422/485 COM port
 - 2 x USB 2.0 ports
 - 2 x LAN ports
- 802.11b/g wireless antenna inside
- Preinstalled Bluetooth module
- The best choice for Thin Client, Windows® CE 5.0 and Windows® XP embedded

AFOLUX VIA C7® and Eden™ Series



AFL-10A-CX
Selectable AT/ATX Power Mode

NEW!



AFL-12B-CX
Selectable AT/ATX Power Mode

NEW!



AFL-15A-CX
Selectable AT/ATX Power Mode



AFL-17A-CX
Selectable AT/ATX Power Mode



AFL-19A-CX
Selectable AT/ATX Power Mode

10.4"

12.1"

15"

17"

19"

- 10.4" embedded panel PC VIA C7 (1.5GHz) CPU with fan or fanless VIA Eden (500MHz) CPU**
- Resolution: 800x600
 - Brightness (cd/m²): 400
 - Touch screen
 - Integrated audio speakers
 - 512 MB memory preinstalled
 - Complete I/O support:
 - 1 x External SATA
 - 1 x RS-232 COM port
 - 1 x RS-232/422/485 COM port
 - 2 x USB 2.0 ports
 - 2 x LAN ports
 - 802.11b/g wireless antenna inside
 - Preinstalled Bluetooth module
 - The best choice for Thin Client, Windows® CE 5.0 and Windows® XP embedded

- 12.1" embedded panel PC VIA C7 (1.5GHz) CPU with fan or fanless VIA Eden (500MHz) CPU**
- Resolution: 1024x768
 - Brightness (cd/m²): 450
 - Touch screen
 - Integrated audio speakers
 - 512 MB memory preinstalled
 - Complete I/O support:
 - 1 x External SATA
 - 1 x RS-232 COM port
 - 1 x RS-232/422/485 COM port
 - 2 x USB 2.0 ports
 - 2 x LAN ports
 - 802.11b/g wireless antenna inside
 - Preinstalled Bluetooth module
 - The best choice for Thin Client, Windows® CE 5.0 and Windows® XP embedded

- 15" embedded panel PC VIA C7® (1.5GHz) CPU with fan or fanless VIA Eden™ (500MHz) CPU**
- Resolution: 1024x768
 - Brightness (cd/m²): 350
 - Touch screen
 - Integrated audio speakers
 - 512 MB memory preinstalled
 - Complete I/O support:
 - 1 x External SATA
 - 1 x RS-232 COM port
 - 1 x RS-232/422/485 COM port
 - 4 x USB 2.0 ports
 - 2 x LAN ports
 - 802.11b/g wireless antenna inside
 - Preinstalled Bluetooth module
 - The best choice for Thin Client, Windows® CE 5.0 and Windows® XP embedded

- 17" embedded panel PC VIA C7® (1.5GHz) CPU with fan or fanless VIA Eden™ (500MHz) CPU**
- Resolution: 1280x1024
 - Brightness (cd/m²): 300
 - Touch screen
 - Integrated audio speakers
 - 512 MB memory preinstalled
 - Complete I/O support:
 - 1 x External SATA
 - 1 x RS-232 COM port
 - 1 x RS-232/422/485 COM port
 - 4 x USB 2.0 ports
 - 2 x LAN ports
 - 1 x VGA port
 - 802.11b/g wireless antenna inside
 - Preinstalled Bluetooth module
 - The best choice for Thin Client, Windows® CE 5.0 and Windows® XP embedded

- 19" embedded panel PC VIA C7® (1.5GHz) CPU with fan or fanless VIA Eden™ (500MHz) CPU**
- Resolution: 1280x1024
 - Brightness (cd/m²): 300
 - Touch screen
 - Integrated audio speakers
 - 512 MB memory preinstalled
 - Complete I/O support:
 - 1 x External SATA
 - 1 x RS-232 COM port
 - 1 x RS-232/422/485 COM port
 - 4 x USB 2.0 ports
 - 2 x LAN ports
 - 1 x VGA port
 - 802.11b/g wireless antenna inside
 - Preinstalled Bluetooth module
 - The best choice for Thin Client, Windows® CE 5.0 and Windows® XP embedded

General Computing

- PC based testing center
- Distance learning



Home and Building Automation

- Digital surveillance system
- Home IA control terminal



Self-service Kiosk

- Self registration terminal
- Interactive photo kiosk
- Ticket vending machine
- Price-check machine



Multimedia Applications

- Gaming device
- Advertising terminal
- Real-time news broadcast



Always Connected

The Value-Added Network Connection



IEI Bluetooth Module

Do wires still inconvenience you when you try to connect peripherals to your PC? A Bluetooth module integrated into the IEI AFOLUX all-in-one panel PC transmits information between peripheral devices through a complete Bluetooth network. The pre-installed Bluetooth module conveniently communicates with a wide variety of peripheral devices including headsets, barcode readers, PDA, printers, cell phones, keyboards and mice.

- Better link quality through accurate frequency selection
- High speed transmission advantage through USB 2.0 Interface
- Direct communication between WLAN device and Bluetooth device through a collaborative coexisting design
- Performance maximization through data prioritization technology
- High connection efficiency supports both page scan and inquiry scan modes



Cellular phone control and monitoring of logistics service vehicles



Emergency medical service



Headset for gaming device



Mobile security surveillance

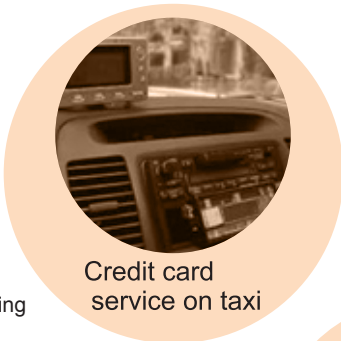

Credit card service on taxi



Public Transportation



Barcode reader for warehouse management

IEI GPRS Module

An optional IEI GPRS module on the AFOLUX all-in-one panel PC enables easier access to the Internet through a GSM network. The GPRS module provides Internet connection mobility enabling centralized control of and access to devices implemented in remote applications like POS devices and delivery service checking devices. (Please note: The GPRS module is for AFL-10A/12A/15A/17A/19A model only. For AFL-12A/15A model, if the GPRS module is used, the HDD can't be installed.)

IEI's Wireless Network Advantage

Wireless Anywhere

If you are still looking for stable wireless LAN connectivity, the integrated PIFA antenna on the AFOLUX ensures an uninterrupted wireless connection. PIFA type antennas can receive high-quality, uniform signals in any location from all directions without any signal degradation or impedance and are the most efficient antennas on the market today. The inverted F-design generates an omni-directional signal field through an exceptionally uniform 3D signal sphere. PIFA enhances transmission and reception through a special cubic structure to ensure optimum wireless performance.

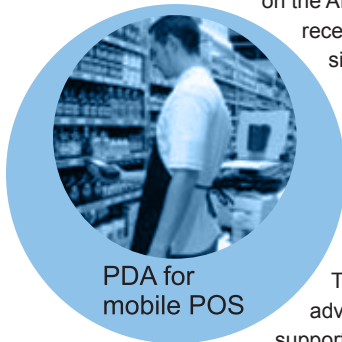

PDA for mobile POS



Delivery item checking of logistic service

Dual LAN support

To provide you with an "Always connected" advantage, IEI has implemented dual LAN support along with PIFA wireless technology, reducing the hazard of network collisions and crashes or virus infection. With the AFOLUX series your network connection never fails.

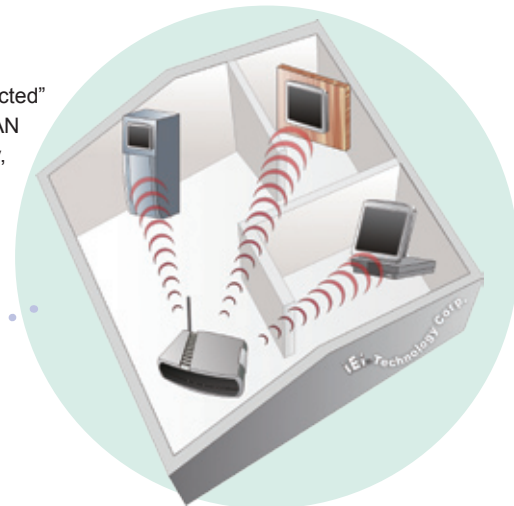

IEI's Fast Transmission Advantage

When communicating at high data rates, or over long distances in real world environments, single-ended methods are often inadequate. Differential data transmission (balanced differential signal) offers superior performance in most applications. Differential signals can help nullify the effects of ground shifts and induced noise signals that can appear as common mode voltages on a network.

- RS422 (differential) was designed for greater distances and higher Baud rates than RS232.
- RS485 meets the requirements for a truly multi-point communications network, and the standard specifies up to 32 drivers and 32 receivers on a single (2-wire)

Specifications	RS232	RS422	RS485
Mode of Operation	Single ended	Differential	Differential
Total Number of Drivers and Receivers on One Line (One driver active at a time for RS485 networks)	1 Driver 1 Receiver	1 Driver 10 Receiver	32 Driver 32 Receiver
Maximum Cable Length	50 FT.	4000 FT.	4000 FT.
Maximum Data Rate (40ft. - 4000ft. for RS422/RS485)	20kb/s	10Mb/s-100Kb/s	10Mb/s-100Kb/s
Maximum Driver Output Voltage	+/-25V	-0.25V to +6V	-7V to +12V
Driver Output Signal Level (Loaded Min.)	Loaded	+/-2.0V	+/-1.5V
Driver Output Signal Level (Unloaded Max)	Unloaded	+/-6V	+/-6V
Driver Load Impedance (Ohms)		100	54
Max. Driver Current in High Z State	Power On	N/A	+/-100uA
Max. Driver Current in High Z State	Power Off	+/-6mA @ +/-2v	+/-100uA
Slew Rate (Max.)		N/A	N/A
Receiver Input Voltage Range	+/-15V	-10V to +10V	-7V to +12V
Receiver Input Sensitivity	+/-3V	+/-200mV	+/-200mV
Receiver Input Resistance (Ohms), (1 Standard Load for RS485)	3k to 7k	4k min.	>=12k



AFL PPC

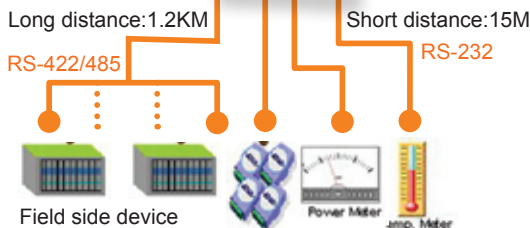

Long distance: 1.2KM

Short distance: 15M

RS-422/485

RS-232

Field side device

Power Meter
Amp. Meter

Flexible Power Mode

AT/ATX Mode Selection

AT and ATX power modes can both be used on the AFOLUX all-in-one panel PC series. Power mode flexibility allows you to select the most suitable power mode for your unique application requirements.

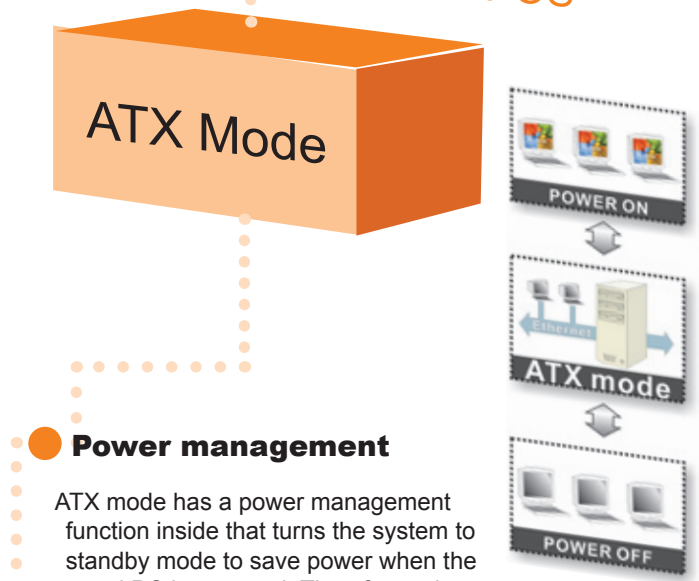
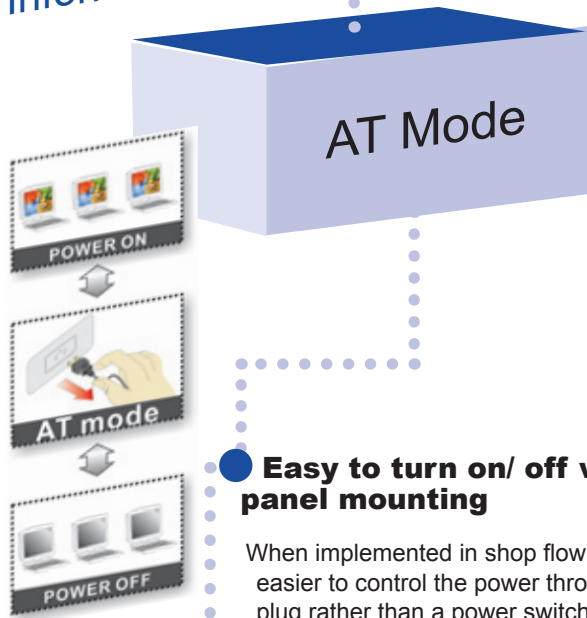

Easy to turn on/ off with wall/ panel mounting

When implemented in shop flow applications it is easier to control the power through the central plug rather than a power switch.

Power management

ATX mode has a power management function inside that turns the system to standby mode to save power when the panel PC is not used. Therefore, when being used in POS applications, real power savings can be achieved.

Automatic start when power connected

When in the AT mode the power is controlled by the central power unit. In AT mode the AFOLUX panel PC automatically starts when the power is connected. This enables multiple panel PCs on a production line to be controlled from a single point.

Remote control advantage

The standby function on the ATX mode power supply allows the AFOLUX panel PC to be turned on/off remotely via network. Users can set up each panel PC to be turned on/off at different times. Remote power mode control is perfect for advertising applications. Broadcasting times for each AFOLUX can be set at a single terminal and controlled remotely.

Industrial Grade Compliance

Watchdog Timer Function

IEI provides the value-added Watchdog Timer function for AFOLUX panel PC series. Watchdog Timer ensures that if the system does not report completion of its information saving task within assigned period of time, the operating system will reboot with or without the information saved. When there's error in the system, the Watchdog Timer function can keep the system working normally through the automatic restart function within a certain amount of time, decreasing the maintenance expense caused by system halted.

Watchdog Timer Software programmable supports 1~255 sec. System reset



With
Watchdog Timer

Automatic Reboot



Without
Watchdog Timer



System Halted
Manual Reboot

Best Reliability

Fanless system

The AMD Geode™ LX 800 and VIA Eden™ processors generate less heat. AFOLUX models with these processors are, while maintaining above-average performance, fanless. Fanless PCs have less down time and extended operational lives as they are not exposed to overheating problems caused by fan failures.

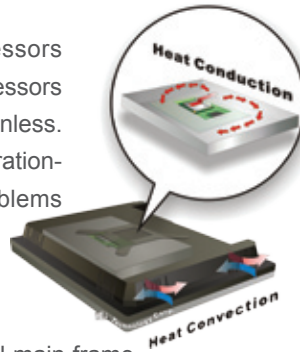

Rugged design

The AFOLUX is directly mounted internally to a metal main frame rather than a fragile plastic cover. In addition, the AFOLUX case is made from ABS/PC (Acrylonitrile Butadiene Styrene/Polycarbonate Alloy), which improves the stiffness over conventional material and makes the system more solid and durable.

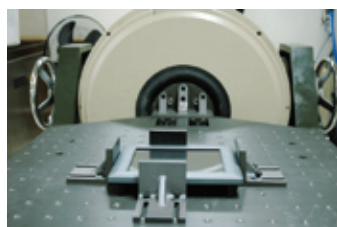
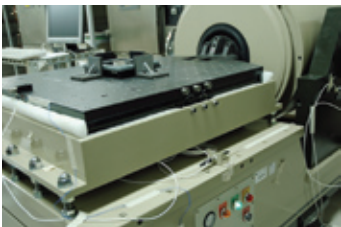

Anti-vibration protection

The AFOLUX panel PC are equipped with a drive kit to increase the resistance of the hard drive to side shocks and vibrations. The drive kit extends the drive life cycle in environments such as vehicles and marine applications.

IP 64 dustproof and waterproof front panel

The AFOLUX front panel is IP 64 compliant. IP 64 compliance guarantees the front panel is dustproof and water-proof. The AFOLUX front panel can withstand any industrial environment where dust and drizzle is encountered.

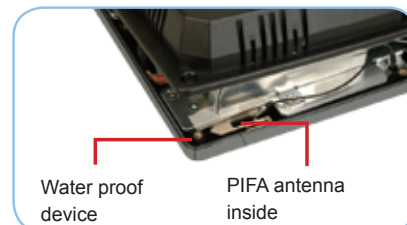

IEI Intelligent System Management



What is IEI Intelligent System Management Module (iSMM) ?

IEI iSMM is a system health supervision API which utilizes sensor chips on AFOLUX PPC to track system and CPU temperatures, voltages, cooling fan speed., WDT and Digital I/O set up status . By quickly capturing and feedback system health data, users can prevent disasters such as system instability or damage.

IEI Exclusive Diagnosis Software

**Full Graphic Interface,
Real-time, 6 in 1 Modules !!**

**INTELLIGENT SYSTEM
MANAGEMENT MODULE**

**IEI Solutions
Compliance Only**

Functions

Temp.

CPU + System temperature monitoring

Fan

Dynamic fan speed controlling

Voltage

Real time voltage alarm

DIO

Easy Digital I/O configuration

WDT

Trouble free watch dog timer testing

Save/Load

Flexibility user profile recover

Features

- External and on-chip voltages data feedback
- Warning signals by beeper and sound effect
- CPU & System temp data feedback
- WDT Test
- Cooling fan speed data feedback
- Programmable Digital I/O
- Cooling fan speed controlled by PWM/On-Off/ Automatic Mode
- System health configurations save and load

Flawless digital media playback with lower CPU usage

The AFOLUX CX series are embedded with VIA CX700M chipset which has unique VIA UniChrome™ Pro II graphic core inside. **VIA UniChrome™ Pro II** graphic core supports the most popular digital video and audio formats through hardware MPEG-2/MPEG-4 hardware decode acceleration, enabling faster multimedia file transmission and better image quality while the CPU is in less consumption.

Without Hardware Decoder

-Lagged image with Higher CPU usage

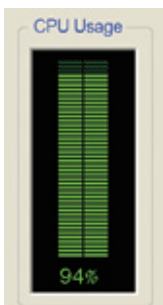

With Hardware Decoder

-Good image quality with Lower CPU usage

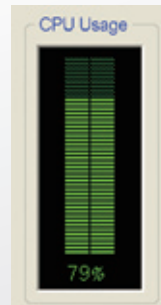

IEI's Turnkey Solution

Embedded OS Supports

IEI provides optional pre-installed Windows® XP Embedded or Windows® CE 5.0 turnkey solutions tailored for the AFOLUX series. These turnkey solutions have one Compact Flash memory card with either Windows® XP Embedded or Windows® CE 5.0 pre-installed, one Windows® XP Embedded or Windows® CE 5.0 license, and one CD that contains all related SDK (Software Development Kit) and user manuals.



- AFLCF-07-LX-CE-R11
- AFLCF-08-LX-CE-R11
- AFLCF-10-LX-CE
- AFLCF-10-CX-CE
- AFLCF-12-LX-CE-R11
- AFLCF-12-CX-CE
- AFLCF-15-CX-CE
- AFLCF-17-CX-CE
- AFLCF-19-CX-CE



Include:

- Windows® CE 5.0 OS image with license
- Thin Client turnkey solutions
- SDK



- AFLCF-07-LX-XPE-R11
- AFLCF-08-LX-XPE-R11
- AFLCF-10-LX-XPE
- AFLCF-10-CX-XPE
- AFLCF-12-LX-XPE-R11
- AFLCF-12-CX-XPE
- AFLCF-15-CX-XPE
- AFLCF-17-CX-XPE
- AFLCF-19-CX-XPE



Include:

- Windows® XPE OS image with license
- Thin Client turnkey solutions

Thin Client Technology

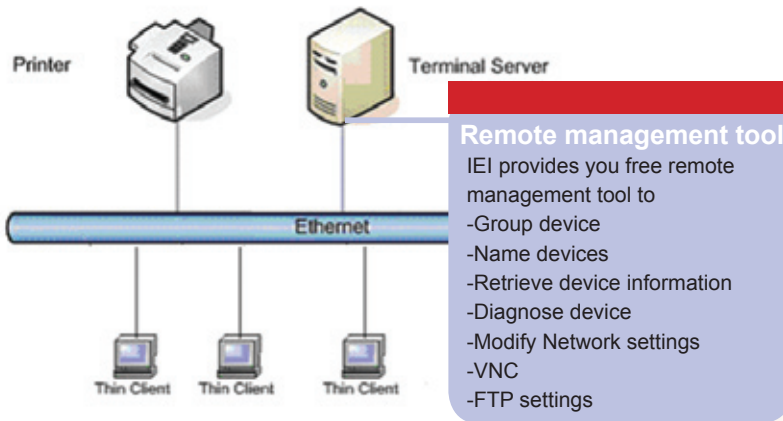

AFOLUX also provides built-in Thin Client Technology in embedded OS turnkey solutions. The thin client technology enables an AFOLUX to access Microsoft Windows-based applications and web-based applications. These applications actually live and run on Microsoft Terminal Service servers, so an AFOLUX can act as a thin client terminal and remotely execute legacy applications, Windows-based SCADA systems, and Windows applications such as word processors, spreadsheets, and database queries.

Advantages of Thin Client Technology

- Reduced hardware cost
- Reduced software cost
- Reduced maintenance cost
- Centrally controlled resources
- Security and protection
- Prevention from client crash

Applications of Thin Client-Server Architecture

- KIOSK
- Thin Client POS
- Logistics
- Terminals for database system
- OA and IT



Dimensions (Unit:mm)

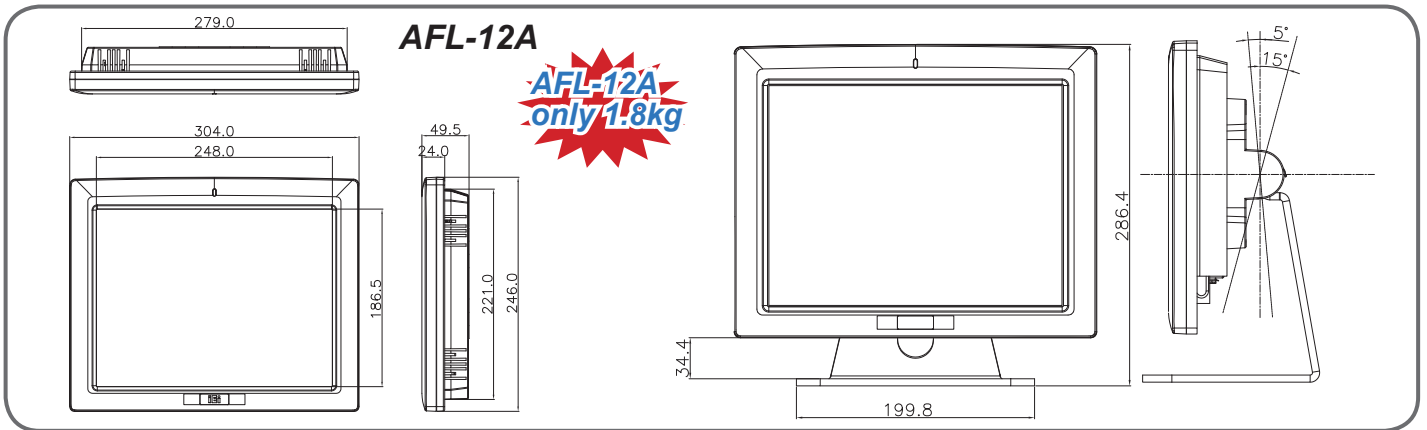
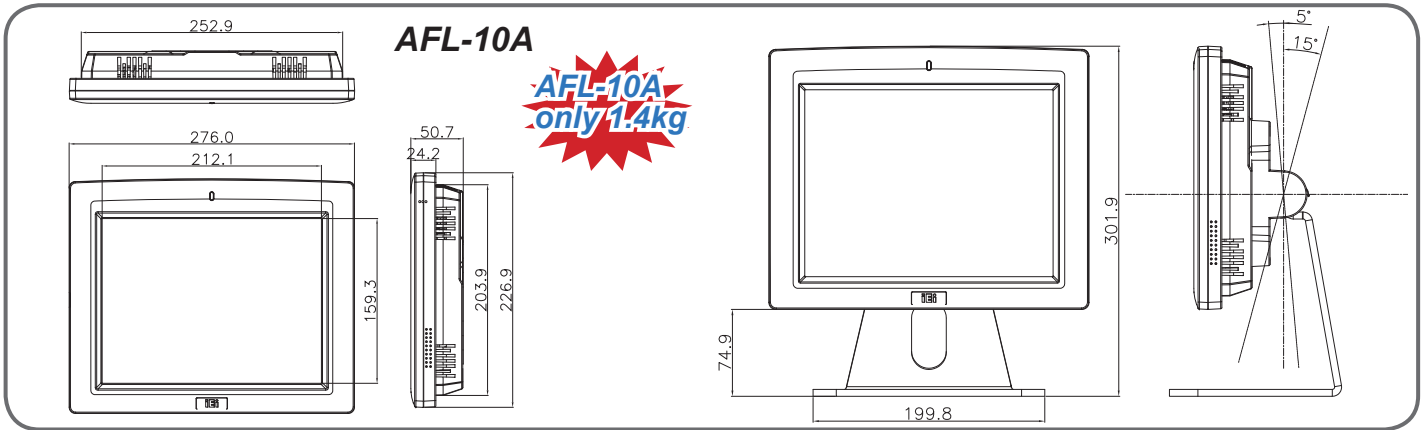
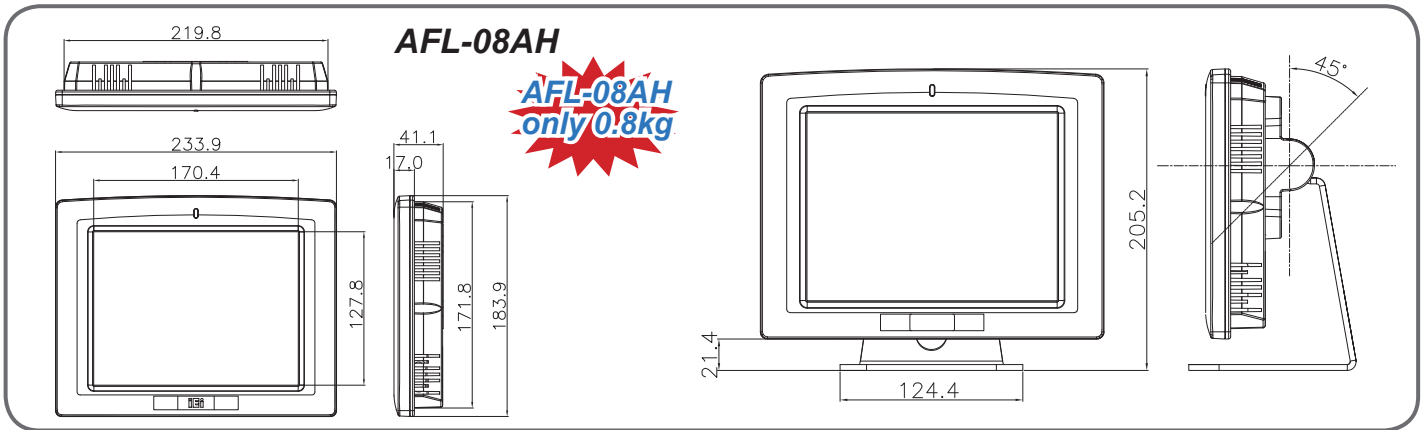
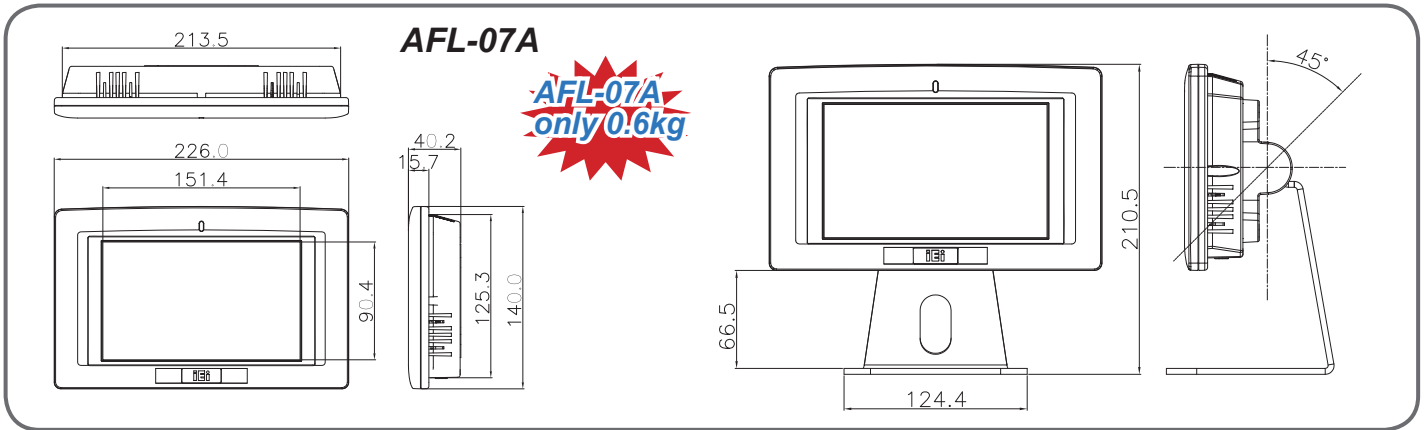

AFOLUX All-in-one Panel PC Family

AFL-12B

**AFL-12B
only 1.8kg**

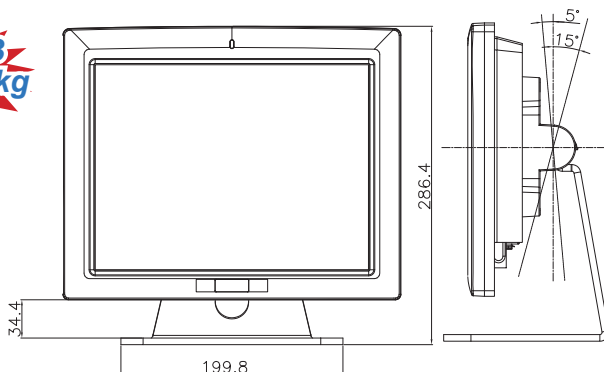
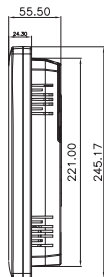
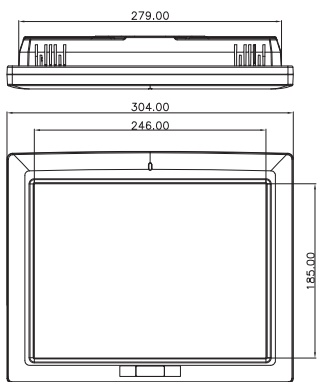

AFL-15A

**AFL-15A
only 3.2kg**

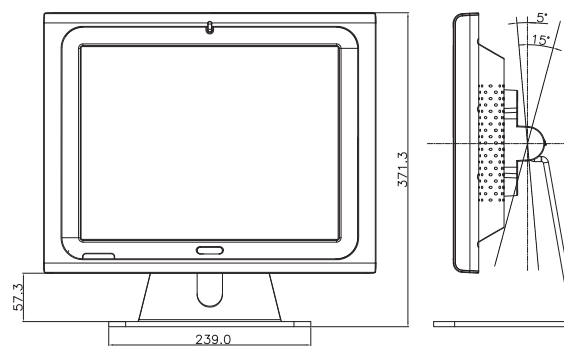
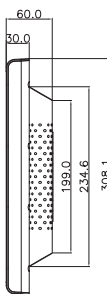
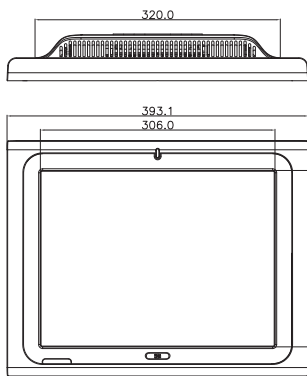

AFL-17A

**AFL-17A
only 5kg**

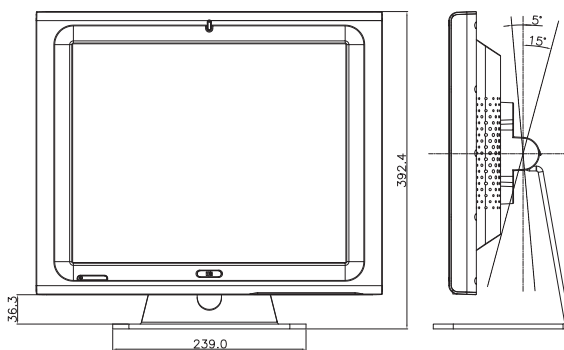
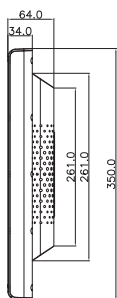
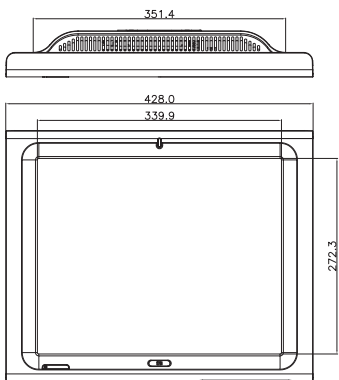

AFL-19A

**AFL-19A
only 5.6kg**

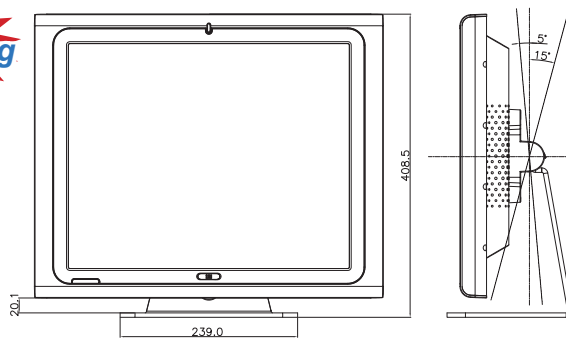
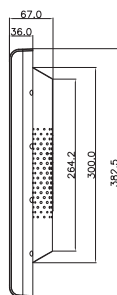
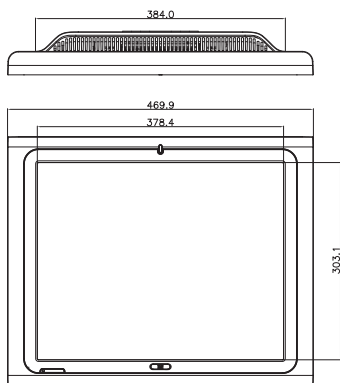



Model	AFL-07A-LX-R11	AFL-08AH-LX-R11	AFL-10A-LX	AFL-12A-LX-R11
LCD Size	7"	8.4"	10.4"	12.1"
Max Resolution	800 * 480	800 * 600	800 * 600	1024 * 768
Brightness (cd/m ²)	350	450	400	450
Contrast Ratio	400:1	500:1	450:1	700:1
LCD Color	262K	262K	262K	262K
Pixel Pitch (mm)	0.1905(H) x 0.1905(V)	0.213(H) x 0.213(V)	0.2112(H) x 0.1584(V)	0.240(H) x 0.240(V)
Viewing Angle (H-V)	140/110	120/100	120/100	160/160
Backlight MTBF	30000	50000	50000	50000
SBC Model	AFLMB-LX800	AFLMB-LX800	AFLMB-LX800	AFLMB-LX800
CPU	AMD Geode™ LX 800 (500MHz)	AMD Geode™ LX 800 (500MHz)	AMD Geode™ LX 800 (500MHz)	AMD Geode™ LX 800 (500MHz)
Chipset	AMD Geode™ LX 800 + AMD Geode™ CS5536	AMD Geode™ LX 800 + AMD Geode™ CS5536	AMD Geode™ LX 800 + AMD Geode™ CS5536	AMD Geode™ LX 800 + AMD Geode™ CS5536
RAM	Supports one 1GB (maximum) 333MHz or 400MHz DDR SO-DIMM	Supports one 1GB (maximum) 333MHz or 400MHz SO-DIMM	Supports one 1GB (maximum) 333MHz or 400MHz SO-DIMM	Supports one 1GB (maximum) 333MHz or 400MHz SO-DIMM
I/O Ports and Switches	1 x RS-232 COM port 1 x RS-232/422/485 COM port 2 x RJ-45 for 10/100Mbps LAN 2 x USB 2.0 1 x Power Switch 1 x Reset Button	1 x RS-232 COM port 1 x RS-232/422/485 COM port 2 x RJ-45 for 10/100Mbps LAN 2 x USB 2.0 1 x Power Switch 1 x Reset Button	1 x RS-232 COM port 1 x RS-232/422/485 COM port 2 x RJ-45 for 10/100Mbps LAN 2 x USB 2.0 1 x Power Switch 1 x Reset Button	1 x RS-232 COM port 1 x RS-232/422/485 COM port 2 x RJ-45 for 10/100Mbps LAN 2 x USB 2.0 1 x Power Switch 1 x Reset Button
SSD	CF Type II	CF Type II	CF Type II	CF Type II
Watchdog Timer	Software programmable supports 1~255 sec. System reset			
Audio	AMP 1.5W + 1.5W	AMP 1.5W + 1.5W	AMP 1.5W + 1.5W	AMP 1.5W + 1.5W
Expansion	1 x Wireless LAN Module (Mini PCI Interface), 1 x Bluetooth Module (USB Interface, Bluetooth V2.0)	1 x Wireless LAN Module (Mini PCI Interface), 1 x Bluetooth Module (USB Interface, Bluetooth V2.0)	1 x Wireless LAN Module (Mini PCI Interface), 1 x Bluetooth Module (USB Interface, Bluetooth V2.0)	1 x Wireless LAN Module (Mini PCI Interface), 1 x Bluetooth Module (USB Interface, Bluetooth V2.0)
HDD Drive Bay	N/A	N/A	N/A	1 x 2.5" HDD bay or Optional GPRS Module
Optional GPRS Module (support GSM 850,EGSM 900,DCS 1800 & PCS 1900)	N/A	N/A	Yes	
Construction Material	ABS + PC Plastic front frame	ABS + PC Plastic front frame	ABS + PC Plastic front frame	ABS + PC Plastic front frame
LED Function	1 x Power ON/OFF LED on front panel	1 x Power ON/OFF LED on front panel	1 x Power ON/OFF LED on front panel	1 x Power ON/OFF LED on front panel
Mounting	Panel, Wall, Rack, Stand or Arm VESA 75mm x 75mm	Panel, Wall, Rack, Stand or Arm VESA 75mm x 75mm	Panel, Wall, Rack, Stand or Arm VESA 75mm x 75mm	Panel, Wall, Rack, Stand or Arm VESA 75mm x 75mm / 100 x 100mm
Front Panel Color	Gray 7539U	Gray 7539U	Gray 7539U	Gray 7539U
Dimension (WxHxD) (mm)	226 x 140 x 41	234 x 184 x 42	276 x 227 x 50.7	304 x 246 x 50
Operation Temperature (°C)	0°C~50°C	0°C~50°C	0°C~50°C	0°C~50°C
Storage Temperature (°C)	-20°C~60°C	-20°C~60°C	-20°C~60°C	-20°C~60°C
Net Weight	0.6Kg	0.8Kg	1.4Kg	1.8Kg
IP Level(front panel)	IP 64	IP 64	IP 64	IP64
EMC	CE, FCC and CCC	CE, FCC and CCC	CE, FCC and CCC	CE, FCC and CCC
Safety	CE, UL and CB	CE, UL and CB	CE, UL and CB	CE, UL and CB
Touch Screen	Resistive Type 4-Wire (touch controller IC is on board)	Resistive Type 4-Wire (touch controller IC is on board)	Resistive Type 5-Wire (touch controller IC is on board)	Resistive Type 5-Wire (touch controller IC is on board)
Power Adapter	P/N: 63000-FSP0361AD101C-RS Power: 36W Input: 90VAC~264VAC @ 50/60Hz Output:12VDC	P/N:63000-FSP0361AD101C-RS Power: 36W Input: 90VAC~264VAC @ 50/60Hz Output:12VDC	P/N:63000-FSP0361AD101C-RS Power: 36W Input: 90VAC~264VAC @ 50/60Hz Output:12VDC	P/N:63000-FSP0361AD101C-RS Power: 36W Input: 90VAC~264VAC @ 50/60Hz Output:12VDC
Power Requirement	12VDC	12VDC	12VDC	12VDC
Power Consumption	20W	20W	25W	29W

Fully Integrated I/O (AFL-07A-LX-R11,AFL-08A-LX-R11, AFL-10A-LX,AFL-12A-LX-R11)

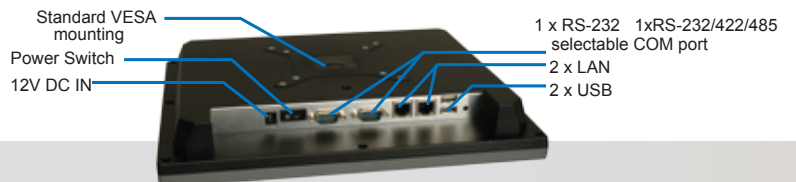



Model	AFL-10A-CX	AFL-12B-CX	AFL-15A-CX	AFL-17A-CX	AFL-19A-CX
LCD Size	10.4"	12.1"	15"	17"	19"
Max Resolution	800 x 600	1024 x 768	1024 x 768	1280 x 1024	1280 x 1024
Brightness (cd/m ²)	400	450	350	300	300
Contrast Ratio	450:1	700:1	400:1	800:1	800:1
LCD Color	262K	262K	262K	16.7M	16.7M
Pixel Pitch (mm)	0.2112(H) x 0.1584(V)	0.240(H) x 0.240(V)	0.297(H) x 0.297(V)	0.264(H) x 0.264(V)	0.294(H) x 0.294(V)
Viewing Angle (H-V)	120/100	160/160	120/100	160(H) / 160(V)	160(H) / 160(V)
Backlight MTBF	50000	50000	50000	50000	50000
SBC Model	AFLMB-CX700	AFLMB-CX700	AFLMB-CX700	AFLMB-CX700	AFLMB-CX700
CPU	VIA C7® (1.5GHz) with fan (noise: 39dB) Fanless VIA Eden™ (500MHz)	VIA C7® (1.5GHz) with fan (noise: 39dB) Fanless VIA Eden™ (500MHz)	VIA C7® (1.5GHz) with fan (noise: 35.1dB) Fanless VIA Eden™ (500MHz)	VIA C7® (1.5GHz) with fan (noise: 39dB) Fanless VIA Eden™ (500MHz)	VIA C7® (1.5GHz) with fan (noise: 39dB) Fanless VIA Eden™ (500MHz)
Chipset	CX700M	CX700M	CX700M	CX700M	CX700M
RAM	Supports one 200-pin 1GB (maximum) 400MHz or 533MHz DDR2 SO-DIMM	Supports one 200-pin 1GB (maximum) 400MHz or 533MHz DDR2 SO-DIMM	Supports one 200-pin 1GB (maximum) 400MHz or 533MHz DDR2 SO-DIMM	Supports one 200-pin 1GB (maximum) 400MHz or 533MHz DDR2 SO-DIMM	Supports one 200-pin 1GB (maximum) 400MHz or 533MHz DDR2 SO-DIMM
I/O Ports and Switches	1x External SATA 1 x RS-232 COM port 1 x RS-232/422/485 COM port 2 x RJ-45 for GbE 2 x USB 2.0 1 x Power Switch 1 x Reset Button	1x External SATA 1 x RS-232 COM port 1 x RS-232/422/485 COM port 2 x RJ-45 for GbE 2 x USB 2.0 1 x Power Switch 1 x Reset Button	1x External SATA 1 x RS-232 COM port 1 x RS-232/422/485 COM port 2 x RJ-45 for GbE 4 x USB 2.0 1 x Power Switch 1 x Reset Button	1x External SATA 1 x RS-232 COM port 1 x RS-232/422/485 COM port 2 x RJ-45 for GbE 4 x USB 2.0 1 x Power Switch 1 x Reset Button 1 x VGA port	1x External SATA 1 x RS-232 COM port 1 x RS-232/422/485 COM port 2 x RJ-45 for GbE 4 x USB 2.0 1 x Power Switch 1 x Reset Button 1 x VGA port
SSD	CF Type II	CF Type II	CF Type II	CF Type II	CF Type II
Watchdog Timer	Software programmable supports 1~255 sec. System reset				
Audio	AMP 1.5W + 1.5W	AMP 1.5W + 1.5W	AMP 1.5W + 1.5W	AMP 1.5W + 1.5W	AMP 1.5W + 1.5W
Expansion	1 x Wireless LAN Module (Mini PCI Interface), 1 x Bluetooth Module (USB Interface, Bluetooth V2.0)	1 x Wireless LAN Module (Mini PCI Interface), 1 x Bluetooth Module (USB Interface, Bluetooth V2.0)	1 x Wireless LAN Module (Mini PCI Interface), 1 x Bluetooth Module (USB Interface, Bluetooth V2.0)	1 x Wireless LAN Module (Mini PCI Interface), 1 x Bluetooth Module (USB Interface, Bluetooth V2.0)	1 x Wireless LAN Module (Mini PCI Interface), 1 x Bluetooth Module (USB Interface, Bluetooth V2.0)
HDD Drive Bay	N/A	1 x 2.5" HDD bay or Optional GPRS Module	1 x 2.5" HDD bay or Optional GPRS Module	1 x 2.5" HDD bay	1 x 2.5" HDD bay
Optional GPRS Module (support GSM 850, EGSM 900, DCS 1800 & PCS 1900)	Yes			Yes	Yes
Construction Material	ABS + PC Plastic front frame	ABS + PC Plastic front frame	ABS + PC Plastic front frame	ABS + PC Plastic front frame	ABS + PC Plastic front frame
LED Function	1 x Power ON/OFF LED on front panel	1 x Power ON/OFF LED on front panel	1 x Power ON/OFF LED on front panel	1 x Power ON/OFF LED on front panel	1 x Power ON/OFF LED on front panel
Mounting	Panel / Wall mounting VESA 75 x 75mm	Panel / Wall mounting VESA 75 x 75mm / 100 x 100mm	Panel, Wall, Rack, Stand and Arm VESA 100mm x 100mm	Panel, Wall, Rack, Stand and Arm VESA 100mm x 100mm	Panel, Wall, Rack, Stand and Arm VESA 100mm x 100mm
Front Panel Color	7539U	7539U	Silver	Silver	Silver
Dimension (WxHxD) (mm)	276 x 226.9 x 50.7	304 x 246 x 55.5	394 x 309 x 61	428 x 350 x 65	470x 383 x 67
Operation Temperature (°C)	0°C~45°C	0°C~45°C	0°C~40°C	0°C~40°C	0°C~40°C
Storage Temperature (°C)	-20°C~60°C	-20°C~60°C	-20°C~60°C	-20°C~60°C	-20°C~60°C
Net Weight	1.4kg	1.8kg	3.2kg	5kg	5.6kg
IP Level(front panel)	IP 64	IP 64	IP 64	IP 64	IP 64
EMC	CE, FCC and CCC	CE, FCC and CCC	CE, FCC and CCC	CE, FCC and CCC	CE, FCC and CCC
Safety	CE, UL and CB	CE, UL and CB	CE, UL and CB	CE, UL and CB	CE, UL and CB
Touch Screen	Resistive Type 5-Wire (touch controller IC is on board)	Resistive Type 5-Wire (touch controller IC is on board)	Resistive Type 5-Wire (touch controller IC is on board)	Resistive Type 5-Wire (touch controller IC is on board)	Resistive Type 5-Wire (touch controller IC is on board)
Power Adapter	P/N:63000-FSP0481AD101C-RS Power: 48W Input: 90VAC~264VAC @ 50/60Hz Output: 12VDC	P/N:63000-FSP0481AD101C-RS Power: 48W Input: 90VAC~264VAC @ 50/60Hz Output: 12VDC	P/N:63000-FSP0361AD101C-RS Power: 80W Input: 90VAC~264VAC @ 50/60Hz Output:12VDC	P/N:63000-FSP0361AD101C-RS Power: 80W Input: 90VAC~264VAC @ 50/60Hz Output:12VDC	P/N:63000-FSP0361AD101C-RS Power: 80W Input: 90VAC~264VAC @ 50/60Hz Output:12VDC
Power Requirement	12VDC	12VDC	12VDC	12VDC	12VDC
Power Consumption	34W	41W	41W	61W	64W

Fully Integrated I/O (AFL-10A-CX, AFL-12B-CX, AFL-15A-CX, AFL-17A-CX, AFL-19A-CX)



Optional Internal GPRS Spec (P/N: GPRS01)

EDGE/GPRS/GSM Air interface	Quad-band operation GSM850, EGSM 900, DCS 1800, PCS 1900 GSM Power Class 4 (2W) for 850/900 bands, GSM Power Class 1 (1W) for 1800/1900 bands EDGE class E2 (+27dBm in 850/900 bands, +26dBm in 1800/1900 bands) GSM/GPRS Rel '97; PCS1900 Rel '98; EGPRS Rel '99 compliant
EGPRS/GPRS (PS) feature set	GPRS Class 10, coding schemes 1-4 EDGE Class 10, Multi-slot classes 1-9 GPRS/EGPRS class B type 1 MT Link Adaptation Incremental redundancy (IR)
Operating System Supported	Windows 2000/XP Home/XP Pro
USB Interface	USB2.0 +5V DC
SIM Card Interface	3.0V interface
Temperature	-30°C to +65°C
Humidity	up to 95% non-condensing
Dimensions	109.3 x 42.7 x 17.7mm

Built-in Bluetooth Spec (USB 2.0 interface) (P/N:BT01)

Standard	Bluetooth V2.0
Frequency Band	2.402GHz ~ 2.480GHz unlicensed ISM band
Modulation Method	GFSK for 1Mbps; Π/4-DQPSK for 2Mbps; 8-DPSK for 3Mbps
Spread Spectrum	FHSS (Frequency Hopping Spread Spectrum)
RF Output Power	Class 2 (under 4 dBm)
Antenna terminal	50 Ohms
DC power	DC 3.3 V or DC 5V
I/O interface	USB v2.0 compliant interface
Two GPIO interface	LED link indicator interface
Dimension	35 x 11 mm
Operating system supported	Windows XP, 2000, 98SE, Me

Options

	AFL-07A-LX-R11	AFL-08AH-LX-R11	AFL-10A-LX AFL-10A-CX	AFL-12A-LX-R11 AFL-12B-CX	AFL-15A-CX	AFL-17A-CX	AFL-19A-CX
Panel mounting kit	AFLPK-08		AFLPK-12		AFLPK-15	AFLPK-17	AFLPK-19
Wall mounting kit	AFLWK-12				AFLWK-19		
Rack mounting kit	AFLRK-07	AFLRK-08	AFLRK-10	AFLRK-12	AFLPK-15	AFLPK-17	AFLPK-19
Stand	STAND-A08		STAND-A12		STAND-A19 STAND-B19		
OS: WIN CE 5.0	*AFLCF-07-LX-CE-R11	*AFLCF-08-LX-CE-R11	*AFLCF-10-LX-CE AFLCF-10-CX-CE	AFLCF-12-LX-CE-R11 AFLCF-12-CX-CE	*AFLCF-15-CX-CE	*AFLCF-17-CX-CE	*AFLCF-19-CX-CE
OS:WIN XPE	*AFLCF-07-LX-XPE-R11	*AFLCF-08-LX-XPE-R11	*AFLCF-10-LX-XPE AFLCF-10-CX-XPE	AFLCF-12-LX-XPE-R11 AFLCF-12-CX-XPE	*AFLCF-15-CX-XPE	*AFLCF-17-CX-XPE	*AFLCF-19-CX-XPE

* Note: Include-CF card, OS image with WINCE or XPE license and IEI Thin Client software package

* CF card capacity with CE 5.0:128MB, with XPE:1GB

Packing List

1 x Power Cable	1xHDD Cable(12.1",15",17",19" model only)
1 x Utility CD	1xSATA HDD Cable(for 12",15",17",19"CXmodel only)
1 x Screw Kit	1xExternal SATA(for 15",17",19"model only)
1 x Touch Pen	1x36W Power Adapter(for 7",8.4",10",12.1"LXmodel only)
	1x80W Power Adapter(for 15",17",19"model only)
	1x48W Power Adapter(for 10.4", 12.1" CX model only)



Ordering Information

** : (GPRS01) for optional GPRS module. GPRS module for AFL-10A/12A/15A/17A/19A model only

Note: For AFL-12A/15A model, if the GPRS module is used, the HDD can't be implemented.

AFL-07A

- AFL-07A-LX/WT-R/256MB-R11: 7", 350cd/m² fanless panel PC with AMD Geode™ LX 800 CPU, 256MB DDR RAM, 802.11b/g wireless module, Bluetooth module and touch screen, RoHS
- AFL-07A-LX/WT-R/512MB-R11: 7", 350cd/m² fanless panel PC with AMD Geode™ LX 800 CPU, 512MB DDR RAM, 802.11b/g wireless module, Bluetooth module and touch screen, RoHS

AFL-08A

- AFL-08AH-LX/WT-R/256MB-R11: 8.4", 450cd/m² fanless panel PC with AMD Geode™ LX 800 CPU, 256MB DDR RAM, 802.11b/g wireless module, Bluetooth module and touch screen, RoHS
- AFL-08AH-LX/WT-R/512MB-R11: 8.4", 450cd/m² fanless panel PC with AMD Geode™ LX 800 CPU, 512MB DDR RAM, 802.11b/g wireless module, Bluetooth module and touch screen, RoHS

AFL-10A

NEW!

- AFL-10A-LX/WT-R/256MB/**(GPRS01): 10.4", 400cd/m² fanless panel PC with AMD Geode™ LX 800 CPU, 256MB DDR RAM, 802.11b/g wireless module, Bluetooth module and touch screen, RoHS
- AFL-10A-LX/WT-R/512MB/**(GPRS01): 10.4", 400cd/m² fanless panel PC with AMD Geode™ LX 800 CPU, 512MB DDR RAM, 802.11b/g wireless module, Bluetooth module and touch screen, RoHS
- AFL-10A-CX-15GZ/WT-R/512MB/**(GPRS01): 10.4", 400cd/m², panel PC with VIA C7® 1.5GHz CPU, 512MB DDR2 RAM, 802.11b/g wireless module, Bluetooth module and touch screen, RoHS
- AFL-10A-CX-05GZ/WT-R/512MB/**(GPRS01): 10.4", 400cd/m², fanless panel PC with VIA Eden™ 500MHz CPU, 512MB DDR2 RAM, 802.11b/g wireless module, Bluetooth module and touch screen, RoHS

AFL-12A

- AFL-12A-LX/WT-R/256MB-R11/**(GPRS01): 12.1", 450cd/m² fanless panel PC with AMD Geode™ LX 800 CPU, 256MB DDR RAM, 802.11b/g wireless module, Bluetooth module and touch screen, RoHS
- AFL-12A-LX/WT-R/512MB-R11/**(GPRS01): 12.1", 450cd/m² fanless panel PC with AMD Geode™ LX 800 CPU, 512MB DDR RAM, 802.11b/g wireless module, Bluetooth module and touch screen, RoHS

AFL-12B

NEW!

- AFL-12B-CX-15GZ/WT-R/512MB/**(GPRS01): 12.1", 450cd/m², panel PC with VIA C7® 1.5GHz CPU, 512MB DDR2 RAM, 802.11b/g wireless module, Bluetooth module and touch screen, RoHS
- AFL-12B-CX-05GZ/WT-R/512MB/**(GPRS01): 12.1", 450cd/m², fanless panel PC with VIA Eden™ 500MHz CPU, 512MB DDR2 RAM, 802.11b/g wireless module, Bluetooth module and touch screen, RoHS

AFL-15A

- AFL-15A-CX-15GZ/WT-R/512MB/**(GPRS01): 15", 350cd/m² panel PC with VIA C7® 1.5GHz CPU, 512MB DDR2 RAM, 802.11b/g wireless module, Bluetooth module and touch screen, RoHS
- AFL-15A-CX-05GZ/WT-R/512MB/**(GPRS01): 15", 350cd/m² fanless panel PC with VIA Eden™ 500MHz CPU, 512MB DDR2 RAM, 802.11b/g wireless module, Bluetooth module and touch screen, RoHS

AFL-17A

- AFL-17A-CX-15GZ/WT-R/512MB/**(GPRS01): 17", 300cd/m² panel PC with VIA C7® 1.5GHz CPU, 512MB DDR2 RAM, 802.11b/g wireless module, Bluetooth module and touch screen, RoHS
- AFL-17A-CX-05GZ/WT-R/512MB/**(GPRS01): 17", 300cd/m² fanless panel PC with VIA Eden™ 500MHz CPU, 512MB DDR2 RAM, 802.11b/g wireless module, Bluetooth module and touch screen, RoHS

AFL-19A

- AFL-19A-CX-15GZ/WT-R/512MB/**(GPRS01): 19", 300cd/m² panel PC with VIA C7® 1.5GHz CPU, 512MB DDR2 RAM, 802.11b/g wireless module, Bluetooth module and touch screen, RoHS
- AFL-19A-CX-05GZ/WT-R/512MB/**(GPRS01): 19", 300cd/m² fanless panel PC with VIA Eden™ 500MHz CPU, 512MB DDR2 RAM, 802.11b/g wireless module, Bluetooth module and touch screen, RoHS