

KA78LXXA / KA78L05AA

3-Terminal 0.1 A Positive Voltage Regulator

Features

- Maximum Output Current of 100 mA
- Output Voltage of 5 V, 6 V, 8 V, 9 V, 10 V, 12 V, 15 V and 18 V
- Thermal Overload Protection
- Short-Circuit Current Limiting
- Output Voltage Offered in $\pm 5\%$ Tolerance

Description

The KA78LXXA / KA78L05AA series of fixed-voltage, monolithic, integrated circuit, voltage regulators are suitable for applications that require supply current up to 100 mA.

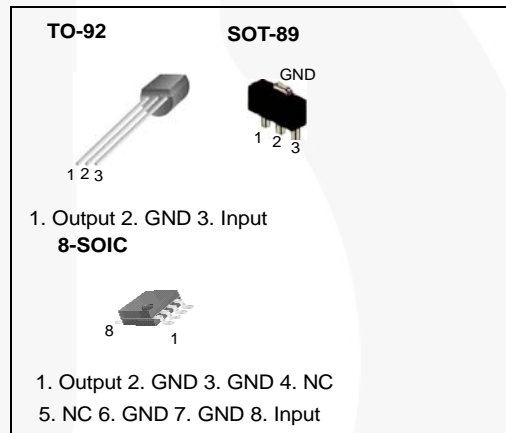

Ordering Information

Product Number	Package	Packing Method	Output Voltage Tolerance	Operating Temperature
KA78L05AZTA	TO-92	Ammo	$\pm 5\%$	0 ~ +125 °C
KA78L05AZBU		Bulk		
KA78L06AZTA		Ammo		
KA78L08AZTA		Ammo		
KA78L09AZTA		Ammo		
KA78L10AZTA		Ammo		
KA78L12AZTA		Ammo		
KA78L15AZTA		Ammo		
KA78L18AZTA		Ammo		
KA78L05AMTF	SOT-89	Tape & Reel	$\pm 5\%$	0 ~ +125 °C
KA78L08AMTF		Tape & Reel		
KA78L12AMTF		Tape & Reel		
KA78L05ADTF	8-SOIC	Tape & Reel	$\pm 3\%$	0 ~ +125 °C
KA78L05AAZTA	TO-92	Ammo		

Block Diagram

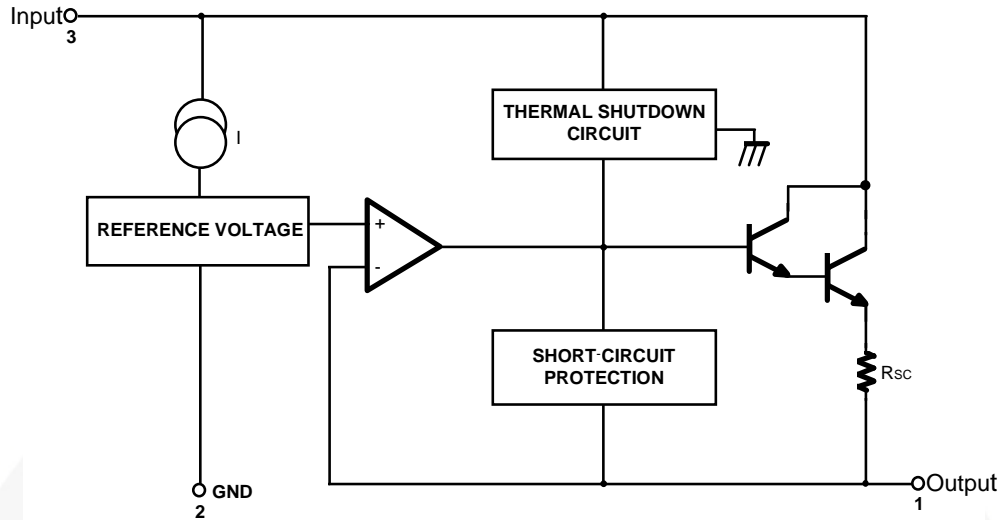

Figure 1. Block Diagram

Absolute Maximum Ratings

Stresses exceeding the absolute maximum ratings may damage the device. The device may not function or be operable above the recommended operating conditions and stressing the parts to these levels is not recommended. In addition, extended exposure to stresses above the recommended operating conditions may affect device reliability. The absolute maximum ratings are stress ratings only. Values are at $T_A = 25^\circ\text{C}$ unless otherwise noted.

Symbol	Parameter		Value	Unit
V_I	Input Voltage	$V_O = 5\text{ V to }8\text{ V}$	30	V
		$V_O = 12\text{ V to }18\text{ V}$	35	V
T_J	Operating Junction Temperature Range		0 to +150	$^\circ\text{C}$
T_{STG}	Storage Temperature Range		-65 to +150	$^\circ\text{C}$
$R_{\theta JC}$	Thermal Resistance, Junction-Case	TO-92	50	$^\circ\text{C/W}$
$R_{\theta JA}$	Thermal Resistance, Junction-Air	TO-92	150	$^\circ\text{C/W}$
		SOT-89	225	$^\circ\text{C/W}$
		8-SOIC	160	$^\circ\text{C/W}$

Electrical Characteristics (KA78L05A)

$V_I = 10\text{ V}$, $I_O = 40\text{ mA}$, $0^\circ\text{C} \leq T_J \leq 125^\circ\text{C}$, $C_I = 0.33\text{ }\mu\text{F}$, $C_O = 0.1\text{ }\mu\text{F}$, unless otherwise specified.

Symbol	Parameter	Conditions	Min.	Typ.	Max.	Unit	
V_O	Output Voltage	$T_J = 25^\circ\text{C}$	4.8	5.0	5.2	V	
ΔV_O	Line Regulation ⁽¹⁾	$T_J = 25^\circ\text{C}$	$7\text{ V} \leq V_I \leq 20\text{ V}$		8	150	mV
			$8\text{ V} \leq V_I \leq 20\text{ V}$		6	100	mV
ΔV_O	Load Regulation ⁽¹⁾	$T_J = 25^\circ\text{C}$	$1\text{ mA} \leq I_O \leq 100\text{ mA}$		11	60	mV
			$1\text{ mA} \leq I_O \leq 40\text{ mA}$		5.0	30	mV
V_O	Output Voltage	$7\text{ V} \leq V_I \leq 20\text{ V}$	$1\text{ mA} \leq I_O \leq 40\text{ mA}$			5.25	V
		$7\text{ V} \leq V_I \leq V_{MAX}^{(2)}$	$1\text{ mA} \leq I_O \leq 70\text{ mA}$	4.75		5.25	V
I_Q	Quiescent Current	$T_J = 25^\circ\text{C}$		2.0	5.5	mA	
ΔI_Q	Quiescent Current Change	With Line	$8\text{ V} \leq V_I \leq 20\text{ V}$			1.5	mA
ΔI_Q		With Load	$1\text{ mA} \leq I_O \leq 40\text{ mA}$			0.1	mA
V_N	Output Noise Voltage	$T_A = 25^\circ\text{C}$, $10\text{ Hz} \leq f \leq 100\text{ kHz}$		40		$\mu\text{V}/V_O$	
$\Delta V_O/\Delta T$	Temperature Coefficient of V_O	$I_O = 5\text{ mA}$		-0.65		$\text{mV}/^\circ\text{C}$	
RR	Ripple Rejection	$f = 120\text{ Hz}$, $8\text{ V} \leq V_I \leq 18\text{ V}$, $T_J = 25^\circ\text{C}$	41	80		dB	
V_D	Dropout Voltage	$T_J = 25^\circ\text{C}$		1.7		V	

Notes:

- The maximum steady-state usable output current and input voltage are very dependent on the heat sinking and/or lead length of the package. The data above represents pulse test conditions with junction temperature as indicated at the initiation of tests.
- Power dissipation: $P_D \leq 0.75\text{ W}$.

Electrical Characteristics (KA78L06A)

$V_I = 12\text{ V}$, $I_O = 40\text{ mA}$, $0^\circ\text{C} \leq T_J \leq 125^\circ\text{C}$, $C_I = 0.33\ \mu\text{F}$, $C_O = 0.1\ \mu\text{F}$, unless otherwise specified.

Symbol	Parameter	Conditions	Min.	Typ.	Max.	Unit	
V_O	Output Voltage	$T_J = 25^\circ\text{C}$	5.75	6.00	6.25	V	
ΔV_O	Line Regulation ⁽³⁾	$T_J = 25^\circ\text{C}$	$8.5\text{ V} \leq V_I \leq 20\text{ V}$		64	175	mV
			$9\text{ V} \leq V_I \leq 20\text{ V}$		54	125	mV
ΔV_O	Load Regulation ⁽³⁾	$T_J = 25^\circ\text{C}$	$1\text{ mA} \leq I_O \leq 100\text{ mA}$		12.8	80.0	mV
			$1\text{ mA} \leq I_O \leq 70\text{ mA}$		5.8	40.0	mV
V_O	Output Voltage	$8.5\text{ V} \leq V_I \leq 20\text{ V}$, $1\text{ mA} \leq I_O \leq 40\text{ mA}$			6.3	V	
		$8.5\text{ V} \leq V_I \leq V_{\text{MAX}}^{(4)}$, $1\text{ mA} \leq I_O \leq 70\text{ mA}$	5.7		6.3	V	
I_Q	Quiescent Current	$T_J = 25^\circ\text{C}$			5.5	mA	
		$T_J = 125^\circ\text{C}$		3.9	6.0	mA	
ΔI_Q	Quiescent Current Change	With Line	$9\text{ V} \leq V_I \leq 20\text{ V}$		1.5	mA	
ΔI_Q		With Load	$1\text{ mA} \leq I_O \leq 40\text{ mA}$		0.1	mA	
V_N	Output Noise Voltage	$T_A = 25^\circ\text{C}$, $10\text{ Hz} \leq f \leq 100\text{ kHz}$		40		$\mu\text{V}/V_O$	
$\Delta V_O/\Delta T$	Temperature Coefficient of V_O	$I_O = 5\text{ mA}$		0.75		$\text{mV}/^\circ\text{C}$	
RR	Ripple Rejection	$f = 120\text{ Hz}$, $10\text{ V} \leq V_I \leq 20\text{ V}$, $T_J = 25^\circ\text{C}$	40	46		dB	
V_D	Dropout Voltage	$T_J = 25^\circ\text{C}$		1.7		V	

Notes:

- The maximum steady-state usable output current and input voltage are very dependent on the heat sinking and/or lead length of the package. The data above represents pulse test conditions with junction temperature as indicated at the initiation of tests.
- Power dissipation: $P_D \leq 0.75\text{ W}$.

Electrical Characteristics (KA78L08A)

$V_I = 14\text{ V}$, $I_O = 40\text{ mA}$, $0^\circ\text{C} \leq T_J \leq 125^\circ\text{C}$, $C_I = 0.33\ \mu\text{F}$, $C_O = 0.1\ \mu\text{F}$, unless otherwise specified.

Symbol	Parameter	Conditions	Min.	Typ.	Max.	Unit	
V_O	Output Voltage	$T_J = 25^\circ\text{C}$	7.7	8.0	8.3	V	
ΔV_O	Line Regulation ⁽⁵⁾	$T_J = 25^\circ\text{C}$	$10.5\text{ V} \leq V_I \leq 23\text{ V}$		10	175	mV
			$11\text{ V} \leq V_I \leq 23\text{ V}$		8	125	mV
ΔV_O	Load Regulation ⁽⁵⁾	$T_J = 25^\circ\text{C}$	$1\text{ mA} \leq I_O \leq 100\text{ mA}$		15	80	mV
			$1\text{ mA} \leq I_O \leq 40\text{ mA}$		8	40	mV
V_O	Output Voltage	$10.5\text{ V} \leq V_I \leq 23\text{ V}$	$1\text{ mA} \leq I_O \leq 40\text{ mA}$	7.6		8.4	V
		$10.5\text{ V} \leq V_I \leq V_{\text{MAX}}^{(6)}$	$1\text{ mA} \leq I_O \leq 70\text{ mA}$	7.6		8.4	V
I_Q	Quiescent Current	$T_J = 25^\circ\text{C}$		2.0	5.5	mA	
ΔI_Q	Quiescent Current Change	With Line	$11\text{ V} \leq V_I \leq 23\text{ V}$			1.5	mA
ΔI_Q		With Load	$1\text{ mA} \leq I_O \leq 40\text{ mA}$			0.1	mA
V_N	Output Noise Voltage	$T_A = 25^\circ\text{C}$, $10\text{ Hz} \leq f \leq 100\text{ kHz}$		60		$\mu\text{V}/V_O$	
$\Delta V_O/\Delta T$	Temperature Coefficient of V_O	$I_O = 5\text{ mA}$		-0.8		$\text{mV}/^\circ\text{C}$	
RR	Ripple Rejection	$f = 120\text{ Hz}$, $11\text{ V} \leq V_I \leq 21\text{ V}$, $T_J = 25^\circ\text{C}$	39	70		dB	
V_D	Dropout Voltage	$T_J = 25^\circ\text{C}$		1.7		V	

Notes:

- The maximum steady-state usable output current and input voltage are very dependent on the heat sinking and/or lead length of the package. The data above represents pulse test conditions with junction temperature as indicated at the initiation of tests.
- Power dissipation: $P_D \leq 0.75\text{ W}$.

Electrical Characteristics (KA78L09A)

$V_I = 15\text{ V}$, $I_O = 40\text{ mA}$, $0^\circ\text{C} \leq T_J \leq 125^\circ\text{C}$, $C_I = 0.33\ \mu\text{F}$, $C_O = 0.1\ \mu\text{F}$, unless otherwise specified.

Symbol	Parameter	Conditions	Min.	Typ.	Max.	Unit	
V_O	Output Voltage	$T_J = 25^\circ\text{C}$	8.64	9.00	9.36	V	
ΔV_O	Line Regulation ⁽⁷⁾	$T_J = 25^\circ\text{C}$	$11.5\text{ V} \leq V_I \leq 24\text{ V}$		90	200	mV
			$13\text{ V} \leq V_I \leq 24\text{ V}$		100	150	mV
ΔV_O	Load Regulation ⁽⁷⁾	$T_J = 25^\circ\text{C}$	$1\text{ mA} \leq I_O \leq 100\text{ mA}$		20	90	mV
			$1\text{ mA} \leq I_O \leq 40\text{ mA}$		10	45	mV
V_O	Output Voltage	$11.5\text{ V} \leq V_I \leq 24\text{ V}$	$1\text{ mA} \leq I_O \leq 40\text{ mA}$	8.55		9.45	V
		$11.5\text{ V} \leq V_I \leq V_{\text{MAX}}^{(8)}$	$1\text{ mA} \leq I_O \leq 70\text{ mA}$	8.55		9.45	V
I_Q	Quiescent Current	$T_J = 25^\circ\text{C}$		2.1	6.0	mA	
ΔI_Q	Quiescent Current Change	With Line	$13\text{ V} \leq V_I \leq 24\text{ V}$			1.5	mA
ΔI_Q		With Load	$1\text{ mA} \leq I_O \leq 40\text{ mA}$			0.1	mA
V_N	Output Noise Voltage	$T_A = 25^\circ\text{C}$, $10\text{ Hz} \leq f \leq 100\text{ kHz}$		70		$\mu\text{V}/V_o$	
$\Delta V_O/\Delta T$	Temperature Coefficient of V_O	$I_O = 5\text{ mA}$		-0.9		$\text{mV}/^\circ\text{C}$	
RR	Ripple Rejection	$f = 120\text{ Hz}$, $12\text{ V} \leq V_I \leq 22\text{ V}$, $T_J = 25^\circ\text{C}$	38	44		dB	
V_D	Dropout Voltage	$T_J = 25^\circ\text{C}$		1.7		V	

Notes:

- The maximum steady-state usable output current and input voltage are very dependent on the heat sinking and/or lead length of the package. The data above represents pulse test conditions with junction temperature as indicated at the initiation of tests.
- Power dissipation: $P_D \leq 0.75\text{ W}$.

Electrical Characteristics (KA78L10A)

$V_I = 16\text{ V}$, $I_O = 40\text{ mA}$, $0^\circ\text{C} \leq T_J \leq 125^\circ\text{C}$, $C_I = 0.33\text{ }\mu\text{F}$, $C_O = 0.1\text{ }\mu\text{F}$, unless otherwise specified.

Symbol	Parameter	Conditions	Min.	Typ.	Max.	Unit	
V_O	Output Voltage	$T_J = 25^\circ\text{C}$	9.6	10.0	10.4	V	
ΔV_O	Line Regulation ⁽⁹⁾	$T_J = 25^\circ\text{C}$	$12.5\text{ V} \leq V_I \leq 25\text{ V}$		100	220	mV
			$14\text{ V} \leq V_I \leq 25\text{ V}$		100	170	mV
ΔV_O	Load Regulation ⁽⁹⁾	$T_J = 25^\circ\text{C}$	$1\text{ mA} \leq I_O \leq 100\text{ mA}$		20	94	mV
			$1\text{ mA} \leq I_O \leq 70\text{ mA}$		10	47	mV
V_O	Output Voltage	$12.5\text{ V} \leq V_I \leq 25\text{ V}$, $1\text{ mA} \leq I_O \leq 40\text{ mA}$	9.5		10.5	V	
		$12.5\text{ V} \leq V_I \leq V_{MAX}^{(10)}$ $1\text{ mA} \leq I_O \leq 70\text{ mA}$	9.5		10.5		
I_Q	Quiescent Current	$T_J = 25^\circ\text{C}$			6.0	mA	
		$T_J = 125^\circ\text{C}$		4.2	6.5		
ΔI_Q	Quiescent Current Change	With Line	$12.5\text{ V} \leq V_I \leq 25\text{ V}$		1.5	mA	
ΔI_Q		With Load	$1\text{ mA} \leq I_O \leq 40\text{ mA}$		0.1		
V_N	Output Noise Voltage	$T_A = 25^\circ\text{C}$, $10\text{ Hz} \leq f \leq 100\text{ kHz}$		74		$\mu\text{V}/V_O$	
$\Delta V_O/\Delta T$	Temperature Coefficient of V_O	$I_O = 5\text{ mA}$		0.95		$\text{mV}/^\circ\text{C}$	
RR	Ripple Rejection	$f = 120\text{ Hz}$, $15\text{ V} \leq V_I \leq 25\text{ V}$, $T_J = 25^\circ\text{C}$	38	43		dB	
V_D	Dropout Voltage	$T_J = 25^\circ\text{C}$		1.7		V	

Notes:

- The maximum steady-state usable output current and input voltage are very dependent on the heat sinking and/or lead length of the package. The data above represents pulse test conditions with junction temperature as indicated at the initiation of tests.
- Power dissipation: $P_D \leq 0.75\text{ W}$.

Electrical Characteristics (KA78L12A)

$V_I = 19\text{ V}$, $I_O = 40\text{ mA}$, $0^\circ\text{C} \leq T_J \leq 125^\circ\text{C}$, $C_I = 0.33\ \mu\text{F}$, $C_O = 0.1\ \mu\text{F}$, unless otherwise specified.

Symbol	Parameter	Conditions	Min.	Typ.	Max.	Unit
V_O	Output Voltage	$T_J = 25^\circ\text{C}$	11.5	12.0	12.5	V
ΔV_O	Line Regulation ⁽¹¹⁾	$T_J = 25^\circ\text{C}$	$14.5\text{ V} \leq V_I \leq 27\text{ V}$	20	250	mV
			$16\text{ V} \leq V_I \leq 27\text{ V}$	15	200	mV
ΔV_O	Load Regulation ⁽¹¹⁾	$T_J = 25^\circ\text{C}$	$1\text{ mA} \leq I_O \leq 100\text{ mA}$	20	100	mV
			$1\text{ mA} \leq I_O \leq 40\text{ mA}$	10	50	mV
V_O	Output Voltage	$14.5\text{ V} \leq V_I \leq 27\text{ V}$	$1\text{ mA} \leq I_O \leq 40\text{ mA}$	11.4	12.6	V
		$14.5\text{ V} \leq V_I \leq V_{\text{MAX}}^{(12)}$	$1\text{ mA} \leq I_O \leq 70\text{ mA}$	11.4	12.6	V
I_Q	Quiescent Current	$T_J = 25^\circ\text{C}$		2.1	6.0	mA
ΔI_Q	Quiescent Current Change	With Line	$16\text{ V} \leq V_I \leq 27\text{ V}$		1.5	mA
ΔI_Q		With Load	$1\text{ mA} \leq I_O \leq 40\text{ mA}$		0.1	mA
V_N	Output Noise Voltage	$T_A = 25^\circ\text{C}$, $10\text{ Hz} \leq f \leq 100\text{ kHz}$		80		$\mu\text{V}/V_o$
$\Delta V_O/\Delta T$	Temperature Coefficient of V_O	$I_O = 5\text{ mA}$		-1.0		$\text{mV}/^\circ\text{C}$
RR	Ripple Rejection	$f = 120\text{ Hz}$, $15\text{ V} \leq V_I \leq 25\text{ V}$, $T_J = 25^\circ\text{C}$	37	65		dB
V_D	Dropout Voltage	$T_J = 25^\circ\text{C}$		1.7		V

Notes:

11. The maximum steady-state usable output current and input voltage are very dependent on the heat sinking and/or lead length of the package. The data above represents pulse test conditions with junction temperature as indicated at the initiation of tests.
12. Power dissipation: $P_D \leq 0.75\text{ W}$.

Electrical Characteristics (KA78L15A)

$V_I = 23 \text{ V}$, $I_O = 40 \text{ mA}$, $0^\circ\text{C} \leq T_J \leq 125^\circ\text{C}$, $C_I = 0.33 \mu\text{F}$, $C_O = 0.1 \mu\text{F}$, unless otherwise specified.

Symbol	Parameter	Conditions	Min.	Typ.	Max.	Unit	
V_O	Output Voltage	$T_J = 25^\circ\text{C}$	14.4	15.0	15.6	V	
ΔV_O	Line Regulation ⁽¹³⁾	$T_J = 25^\circ\text{C}$	$17.5 \text{ V} \leq V_I \leq 30 \text{ V}$		25	300	mV
			$20 \text{ V} \leq V_I \leq 30 \text{ V}$		20	250	mV
ΔV_O	Load Regulation ⁽¹³⁾	$T_J = 25^\circ\text{C}$	$1 \text{ mA} \leq I_O \leq 100 \text{ mA}$		25	150	mV
			$1 \text{ mA} \leq I_O \leq 40 \text{ mA}$		12	75	mV
V_O	Output Voltage	$17.5 \text{ V} \leq V_I \leq 30 \text{ V}$	$1 \text{ mA} \leq I_O \leq 40 \text{ mA}$	14.25		15.75	V
		$17.5 \text{ V} \leq V_I \leq V_{\text{MAX}}^{(14)}$	$1 \text{ mA} \leq I_O \leq 70 \text{ mA}$	14.25		15.75	V
I_Q	Quiescent Current	$T_J = 25^\circ\text{C}$		2.1	6.0	mA	
ΔI_Q	Quiescent Current Change	With Line	$20 \text{ V} \leq V_I \leq 30 \text{ V}$		1.5	mA	
ΔI_Q		With Load	$1 \text{ mA} \leq I_O \leq 40 \text{ mA}$		0.1	mA	
V_N	Output Noise Voltage	$T_A = 25^\circ\text{C}$, $10 \text{ Hz} \leq f \leq 100 \text{ kHz}$		90		$\mu\text{V}/V_O$	
$\Delta V_O/\Delta T$	Temperature Coefficient of V_O	$I_O = 5 \text{ mA}$		-1.3		$\text{mV}/^\circ\text{C}$	
RR	Ripple Rejection	$f = 120 \text{ Hz}$, $18.5 \text{ V} \leq V_I \leq 28.5 \text{ V}$, $T_J = 25^\circ\text{C}$	34	60		dB	
V_D	Dropout Voltage	$T_J = 25^\circ\text{C}$		1.7		V	

Notes:

13. The maximum steady-state usable output current and input voltage are very dependent on the heat sinking and/or lead length of the package. The data above represents pulse test conditions with junction temperature as indicated at the initiation of tests.

14. Power dissipation: $P_D \leq 0.75 \text{ W}$.

Electrical Characteristics (KA78L18A)

$V_I = 27V$, $I_O = 40mA$, $0^\circ C \leq T_J \leq 125^\circ C$, $C_I = 0.33 \mu F$, $C_O = 0.1 \mu F$, unless otherwise specified.

Symbol	Parameter	Conditions	Min.	Typ.	Max.	Unit	
V_O	Output Voltage	$T_J = 25^\circ C$	17.3	18.0	18.7	V	
ΔV_O	Line Regulation ⁽¹⁵⁾	$T_J = 25^\circ C$	$21 V \leq V_I \leq 33 V$		145	300	mV
			$22 V \leq V_I \leq 33 V$		135	250	mV
ΔV_O	Load Regulation ⁽¹⁵⁾	$T_J = 25^\circ C$	$1 mA \leq I_O \leq 100 mA$		30	170	mV
			$1 mA \leq I_O \leq 40 mA$		15	85	mV
V_O	Output Voltage	$21 V \leq V_I \leq 33 V$	$1 mA \leq I_O \leq 40 mA$	17.1		18.9	V
		$21 V \leq V_I \leq V_{MAX}^{(16)}$	$1 mA \leq I_O \leq 70 mA$	17.1		18.9	V
I_Q	Quiescent Current	$T_J = 25^\circ C$		2.2	6.0	mA	
ΔI_Q	Quiescent Current Change	With Line	$21 V \leq V_I \leq 33 V$		1.5	mA	
ΔI_Q		With Load	$1 mA \leq I_O \leq 40 mA$		0.1	mA	
V_N	Output Noise Voltage	$T_A = 25^\circ C$, $10 Hz \leq f \leq 100 kHz$		150		$\mu V/V_O$	
$\Delta V_O/\Delta T$	Temperature Coefficient of V_O	$I_O = 5 mA$		-1.8		$mV/^\circ C$	
RR	Ripple Rejection	$f = 120 Hz$, $23 V \leq V_I \leq 33V$, $T_J = 25^\circ C$	34	48		dB	
V_D	Dropout Voltage	$T_J = 25^\circ C$		1.7		V	

Notes:

15. The maximum steady-state usable output current and input voltage are very dependent on the heat sinking and/or lead length of the package. The data above represents pulse test conditions with junction temperature as indicated at the initiation of tests.
16. Power dissipation: $P_D \leq 0.75 W$.

Electrical Characteristics (KA78L05AA)

$V_I = 10\text{ V}$, $I_O = 40\text{ mA}$, $0^\circ\text{C} \leq T_J \leq 125^\circ\text{C}$, $C_I = 0.33\ \mu\text{F}$, $C_O = 0.1\ \mu\text{F}$, unless otherwise specified.

Symbol	Parameter	Conditions	Min.	Typ.	Max.	Unit	
V_O	Output Voltage	$T_J = 25^\circ\text{C}$	4.9	5.0	5.1	V	
ΔV_O	Line Regulation ⁽¹⁷⁾	$T_J = 25^\circ\text{C}$	$7\text{ V} \leq V_I \leq 20\text{ V}$		8	150	mV
			$8\text{ V} \leq V_I \leq 20\text{ V}$		6	100	mV
ΔV_O	Load Regulation ⁽¹⁷⁾	$T_J = 25^\circ\text{C}$	$1\text{ mA} \leq I_O \leq 100\text{ mA}$		11	50	mV
			$1\text{ mA} \leq I_O \leq 40\text{ mA}$		5.0	25	mV
V_O	Output Voltage	$7\text{ V} \leq V_I \leq 20\text{ V}$	$1\text{ mA} \leq I_O \leq 40\text{ mA}$			5.15	V
		$7\text{ V} \leq V_I \leq V_{\text{MAX}}^{(18)}$	$1\text{ mA} \leq I_O \leq 70\text{ mA}$	4.85		5.15	V
I_Q	Quiescent Current	$T_J = 25^\circ\text{C}$		2.0	5.5	mA	
ΔI_Q	Quiescent Current Change	With Line	$8\text{ V} \leq V_I \leq 20\text{ V}$			1.5	mA
ΔI_Q		With Load	$1\text{ mA} \leq I_O \leq 40\text{ mA}$			0.1	mA
V_N	Output Noise Voltage	$T_A = 25^\circ\text{C}$, $10\text{ Hz} \leq f \leq 100\text{ kHz}$		40		$\mu\text{V}/V_O$	
$\Delta V_O/\Delta T$	Temperature Coefficient of V_O	$I_O = 5\text{ mA}$		-0.65		$\text{mV}/^\circ\text{C}$	
RR	Ripple Rejection	$f = 120\text{ Hz}$, $8\text{ V} \leq V_I \leq 18\text{ V}$, $T_J = 25^\circ\text{C}$	41	80		dB	
V_D	Dropout Voltage	$T_J = 25^\circ\text{C}$		1.7		V	

Notes:

17. The maximum steady-state usable output current and input voltage are very dependent on the heat sinking and/or lead length of the package. The data above represents pulse test conditions with junction temperature as indicated at the initiation of tests.

18. Power dissipation: $P_D \leq 0.75\text{ W}$.

Typical Application

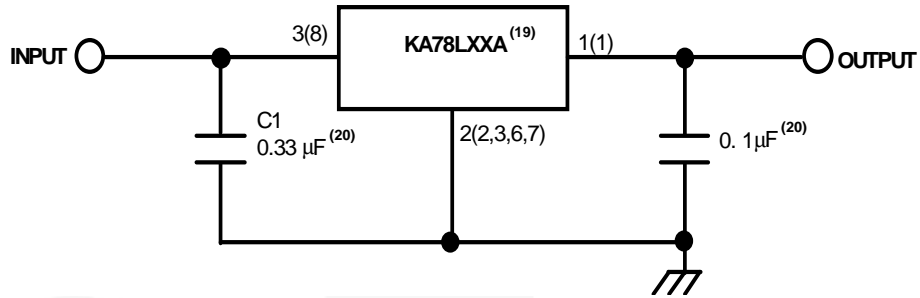

Figure 2. Typical Application

Notes:

- 19. To specify an output voltage, substitute voltage value for "XX".
- 20. Bypass capacitors are recommended for optimum stability and transient response and should be located as close as possible to the regulator.

Physical Dimensions

SOT-89

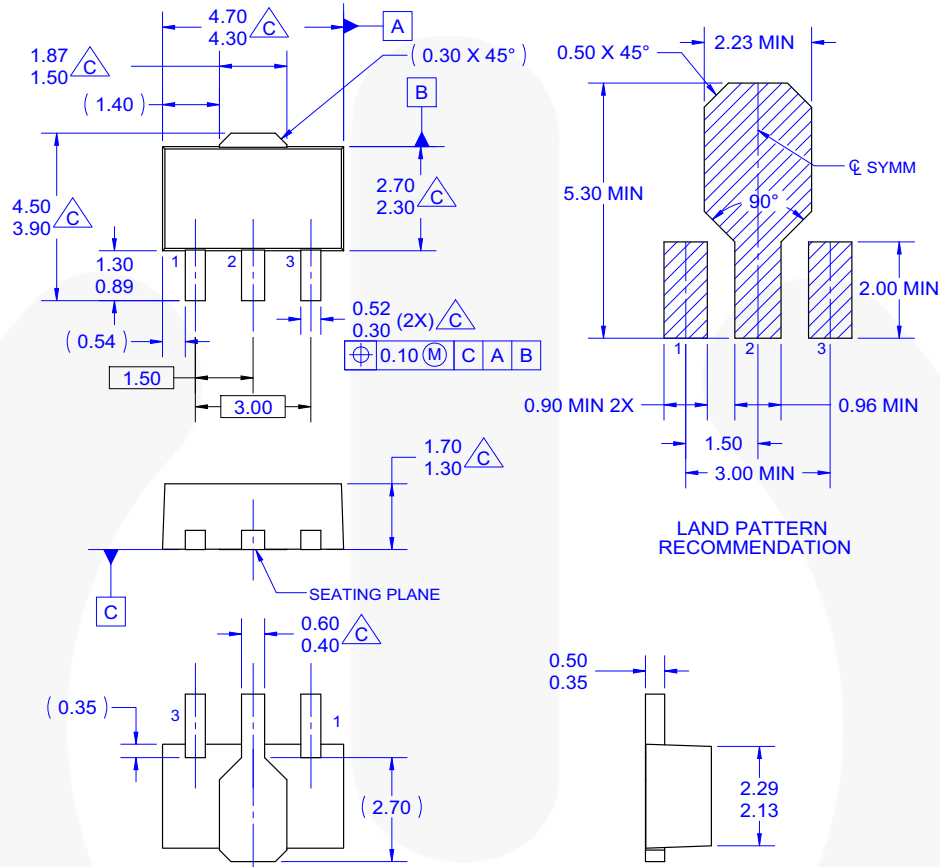

- NOTES: UNLESS OTHERWISE SPECIFIED.
- A. REFERENCE TO JEDEC TO-243 VARIATION AA.
 - B. ALL DIMENSIONS ARE IN MILLIMETERS.
 - △ DOES NOT COMPLY JEDEC STANDARD VALUE.
 - D. DIMENSIONS ARE EXCLUSIVE OF BURRS, MOLD FLASH AND TIE BAR PROTRUSION.
 - E. DIMENSION AND TOLERANCE AS PER ASME Y14.5-1994.
 - F. DRAWING FILE NAME: MA03CREV2

Figure 3. 3-Lead, SOT-89, JEDEC TO-243, Option AA

Package drawings are provided as a service to customers considering Fairchild components. Drawings may change in any manner without notice. Please note the revision and/or date on the drawing and contact a Fairchild Semiconductor representative to verify or obtain the most recent revision. Package specifications do not expand the terms of Fairchild's worldwide terms and conditions, specifically the warranty therein, which covers Fairchild products.

Always visit Fairchild Semiconductor's online packaging area for the most recent package drawings:
<http://www.fairchildsemi.com/packaging/>

For current tape and reel specifications, visit Fairchild Semiconductor's online packaging area:
http://www.fairchildsemi.com/packaging/tr/sot89_tr.pdf

Physical Dimensions (Continued)

TO-92 Straight Lead for Bulk Packing

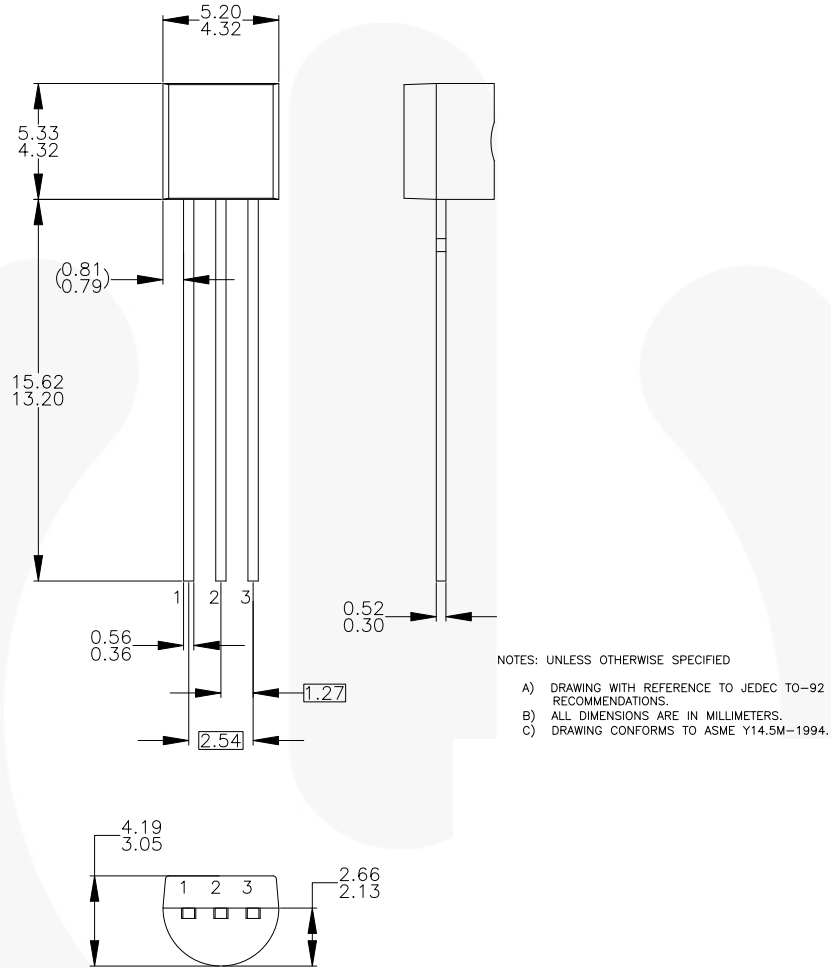

Figure 4. 3LD, TO-92, MOLDED STD STRAIGHT LD(NO EOL CODE)

Package drawings are provided as a service to customers considering Fairchild components. Drawings may change in any manner without notice. Please note the revision and/or date on the drawing and contact a Fairchild Semiconductor representative to verify or obtain the most recent revision. Package specifications do not expand the terms of Fairchild's worldwide terms and conditions, specifically the warranty therein, which covers Fairchild products.

Always visit Fairchild Semiconductor's online packaging area for the most recent package drawings:
<http://www.fairchildsemi.com/packaging/>

For current tape and reel specifications, visit Fairchild Semiconductor's online packaging area:
http://www.fairchildsemi.com/packaging/tr/to92pdd_tr.pdf

Physical Dimensions (Continued)

TO-92 Formed Lead For T&R and Ammo Packing

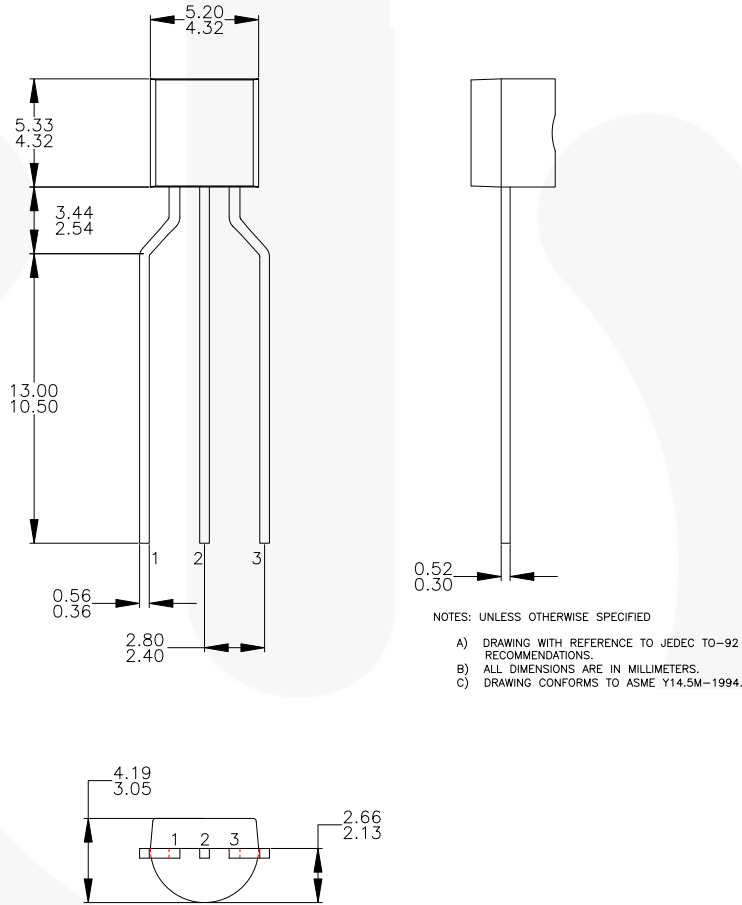

Figure 5. 3LD, TO-92, MOLDED 0.200 IN LINE SPACING LD FORM (J61Z OPTION)

Package drawings are provided as a service to customers considering Fairchild components. Drawings may change in any manner without notice. Please note the revision and/or date on the drawing and contact a Fairchild Semiconductor representative to verify or obtain the most recent revision. Package specifications do not expand the terms of Fairchild's worldwide terms and conditions, specifically the warranty therein, which covers Fairchild products.

Always visit Fairchild Semiconductor's online packaging area for the most recent package drawings:

<http://www.fairchildsemi.com/packaging/>

For current tape and reel specifications, visit Fairchild Semiconductor's online packaging area:

http://www.fairchildsemi.com/packaging/tr/to92_tr.pdf

Physical Dimensions (Continued)

8-SOIC

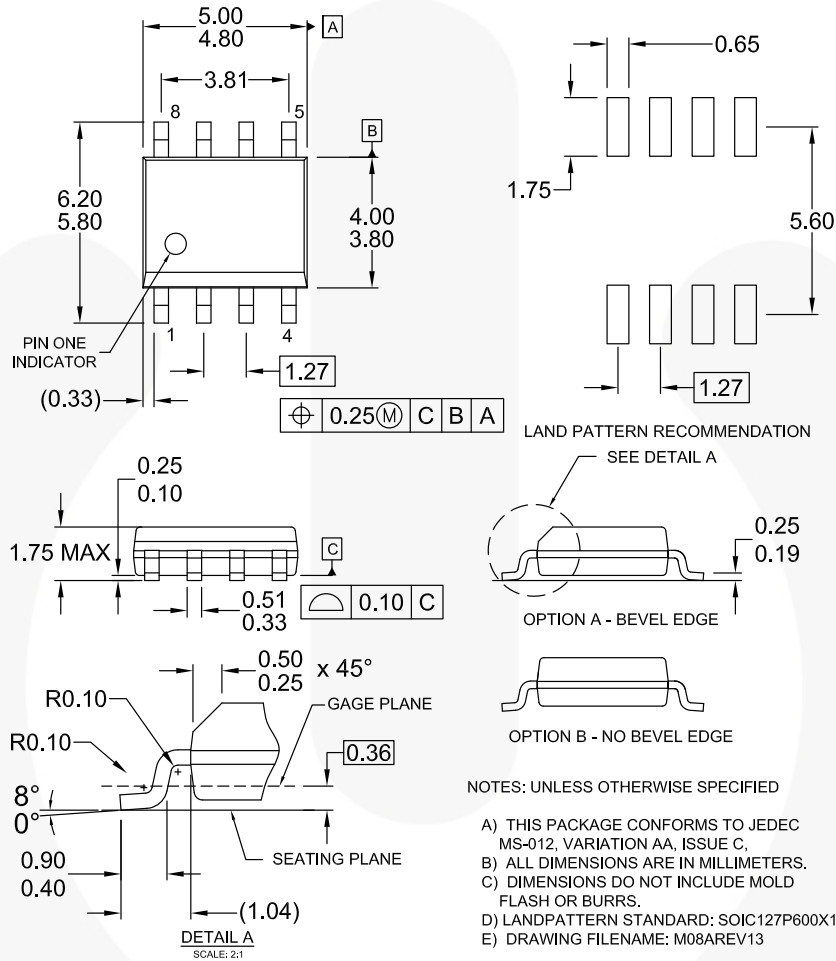

Figure 6. 8LD, SOIC, JEDEC MS-012, 0.150" NARROW BODY

Package drawings are provided as a service to customers considering Fairchild components. Drawings may change in any manner without notice. Please note the revision and/or date on the drawing and contact a Fairchild Semiconductor representative to verify or obtain the most recent revision. Package specifications do not expand the terms of Fairchild's worldwide terms and conditions, specifically the warranty therein, which covers Fairchild products.





Always visit Fairchild Semiconductor's online packaging area for the most recent package drawings:
<http://www.fairchildsemi.com/packaging/>

For current tape and reel specifications, visit Fairchild Semiconductor's online packaging area:
http://www.fairchildsemi.com/packaging/tr/soic8_tr.pdf



TRADEMARKS

The following includes registered and unregistered trademarks and service marks, owned by Fairchild Semiconductor and/or its global subsidiaries, and is not intended to be an exhaustive list of all such trademarks.

- | | | | |
|---|--|---|---|
| 2Cool™ | FPS™ |  | Sync-Lock™ |
| AccuPower™ | F-PFS™ | PowerTrench® |  |
| AX-CAP®* | FRFET® | PowerXS™ | TinyBoost™ |
| BitSiC™ | Global Power Resource SM | Programmable Active Droop™ | TinyBuck™ |
| Build it Now™ | GreenBridge™ | QFET® | TinyCalc™ |
| CorePLUS™ | Green FPS™ | QS™ | TinyLogic® |
| CorePOWER™ | Green FPS™ e-Series™ | Quiet Series™ | TINYOPTO™ |
| CROSSVOLT™ | Gmax™ | RapidConfigure™ | TinyPower™ |
| CTL™ | GTO™ |  | TinyPWM™ |
| Current Transfer Logic™ | IntelliMAX™ | Saving our world, 1mW/W/kW at a time™ | TinyWire™ |
| DEUXPEED® | ISOPLANAR™ | SignalWise™ | TranSiC™ |
| Dual Cool™ | Making Small Speakers Sound Louder and Better™ | SmartMax™ | TriFault Detect™ |
| EcoSPARK® | MegaBuck™ | SMART START™ | TRUECURRENT®* |
| EfficientMax™ | MICROCOUPLER™ | Solutions for Your Success™ | μSerDes™ |
| ESBC™ | MicroFET™ | SPM® |  |
|  | MicroPak™ | STEALTH™ | UHC® |
| Fairchild® | MicroPak2™ | SuperFET® | Ultra FRFET™ |
| Fairchild Semiconductor® | MillerDrive™ | SuperSOT™-3 | UniFET™ |
| FACT Quiet Series™ | MotionMax™ | SuperSOT™-6 | VXC™ |
| FACT® | mWSaver™ | SuperSOT™-8 | VisualMax™ |
| FAST® | OptoHi™ | SupreMOS® | VoltagePlus™ |
| FastvCore™ | OPTOLOGIC® | SyncFET™ | XS™ |
| FETBench™ | OPTOPLANAR® | | |

* Trademarks of System General Corporation, used under license by Fairchild Semiconductor.

DISCLAIMER

FAIRCHILD SEMICONDUCTOR RESERVES THE RIGHT TO MAKE CHANGES WITHOUT FURTHER NOTICE TO ANY PRODUCTS HEREIN TO IMPROVE RELIABILITY, FUNCTION, OR DESIGN. FAIRCHILD DOES NOT ASSUME ANY LIABILITY ARISING OUT OF THE APPLICATION OR USE OF ANY PRODUCT OR CIRCUIT DESCRIBED HEREIN; NEITHER DOES IT CONVEY ANY LICENSE UNDER ITS PATENT RIGHTS, NOR THE RIGHTS OF OTHERS. THESE SPECIFICATIONS DO NOT EXPAND THE TERMS OF FAIRCHILD'S WORLDWIDE TERMS AND CONDITIONS, SPECIFICALLY THE WARRANTY THEREIN, WHICH COVERS THESE PRODUCTS.

LIFE SUPPORT POLICY

FAIRCHILD'S PRODUCTS ARE NOT AUTHORIZED FOR USE AS CRITICAL COMPONENTS IN LIFE SUPPORT DEVICES OR SYSTEMS WITHOUT THE EXPRESS WRITTEN APPROVAL OF FAIRCHILD SEMICONDUCTOR CORPORATION.

As used herein:

1. Life support devices or systems are devices or systems which, (a) are intended for surgical implant into the body or (b) support or sustain life, and (c) whose failure to perform when properly used in accordance with instructions for use provided in the labeling, can be reasonably expected to result in a significant injury of the user.
2. A critical component in any component of a life support, device, or system whose failure to perform can be reasonably expected to cause the failure of the life support device or system, or to affect its safety or effectiveness.

ANTI-COUNTERFEITING POLICY

Fairchild Semiconductor Corporation's Anti-Counterfeiting Policy. Fairchild's Anti-Counterfeiting Policy is also stated on our external website, www.fairchildsemi.com, under Sales Support.

Counterfeiting of semiconductor parts is a growing problem in the industry. All manufacturers of semiconductor products are experiencing counterfeiting of their parts. Customers who inadvertently purchase counterfeit parts experience many problems such as loss of brand reputation, substandard performance, failed applications, and increased cost of production and manufacturing delays. Fairchild is taking strong measures to protect ourselves and our customers from the proliferation of counterfeit parts. Fairchild strongly encourages customers to purchase Fairchild parts either directly from Fairchild or from Authorized Fairchild Distributors who are listed by country on our web page cited above. Products customers buy either from Fairchild directly or from Authorized Fairchild Distributors are genuine parts, have full traceability, meet Fairchild's quality standards for handling and storage and provide access to Fairchild's full range of up-to-date technical and product information. Fairchild and our Authorized Distributors will stand behind all warranties and will appropriately address any warranty issues that may arise. Fairchild will not provide any warranty coverage or other assistance for parts bought from Unauthorized Sources. Fairchild is committed to combat this global problem and encourage our customers to do their part in stopping this practice by buying direct or from authorized distributors.

PRODUCT STATUS DEFINITIONS

Definition of Terms

Datasheet Identification	Product Status	Definition
Advance Information	Formative / In Design	Datasheet contains the design specifications for product development. Specifications may change in any manner without notice.
Preliminary	First Production	Datasheet contains preliminary data; supplementary data will be published at a later date. Fairchild Semiconductor reserves the right to make changes at any time without notice to improve design.
No Identification Needed	Full Production	Datasheet contains final specifications. Fairchild Semiconductor reserves the right to make changes at any time without notice to improve the design.
Obsolete	Not In Production	Datasheet contains specifications on a product that is discontinued by Fairchild Semiconductor. The datasheet is for reference information only.